

/20

EMIL
CERAMICA

INDICE ALFABETICO

Alphabetical index
Index alphabétique
Alphabetischen index
Índice alfabético
Алфавитный указатель

20Twenty	20
Anthology Stone	26
Be-Square	32
Brick Design	42
Brixen Stone	46
Chateau	52
Dimore	58
Eterna	62
Externa	68
Externa Cotto	72
Externa Quarzite	76
Kotto	80
Millelegni	90
Millelegni Remake	96
Nordika	102
On Square	108
Petra	116
Piase	122
Sleek Wood	130
Stone Box	134
Tele di Marmo	140
Tele di Marmo Reloaded	156
Tele di Marmo Revolution	172
Totalook	180
Tracce	190

Applicazioni Tecniche Technical Applications Applications Techniques Technische Anwendungsbereiche Aplicaciones Técnicas Технические Применения	
Pave & Go	200

Facciate ventilate Ventilated Facade Façade Ventilée Vorgehängte Hinterlüftete Fassade Fachada Ventilada Вентилируемый Фасад	214
---	-----

Pavimenti sopraelevati Cavity Floors Planchers Surélevés Doppelböden Pavimentos Sobreelevados Фальшполы	224
--	-----

Sezione tecnica Technical information Section technique Technische Angaben Sección técnica Технический раздел	234
--	-----

Sistema Gestione Integrato integrated Management System Système de gestion intégré Integriertes Management system Sistema de gestión integrado Интегрированная система менеджмента	6
---	---

FASCIA DI PREZZO

Price band | Gamme de prix | Preisgruppe | Franja de precio | Код ценового сегмента

- Prezzo al Mq**
Price per Sqm | Prix au m² | Preis pro Qm | Precio por Mc | Цена за кв.м.
- Prezzo al Pezzo**
Price per piece | Prix à l'unité | Preis pro Stück | Precio por pieza | Цена за штуку

INDICE PER FORMATO

Index by format
Index selon le format
Index nach format
Índice por formato
Индекс по формату

120x278  6,5 mm.	
Tele di Marmo Revolution	172

120x240  6,5 mm.	
Be-Square	32
Tele di Marmo	140
Tele di Marmo Reloaded	156

120x120  6,5 mm.	
Be-Square	32
Tele di Marmo	140
Tele di Marmo Reloaded	156
Totalook	180

60x120  6,5 mm.	
Totalook	180

120x120	
Chateau	52

22,5x180	
20Twenty	20

25x150	
20Twenty	20
Millelegni Remake	96

60x120	
Be-Square	32
Chateau	52
Eterna	62
Nordika	102
On Square	108
Piase	122
Tele di Marmo	140
Tele di Marmo Reloaded	156
Tele di Marmo Revolution	172

30x120	
Millelegni	90

20x120	
20Twenty	20
Dimore	58
Millelegni	90
Millelegni Remake	96

30x120	
Millelegni	90

20x120	
20Twenty	20
Dimore	58
Millelegni	90
Millelegni Remake	96

15x120	
Millelegni	90

90x90	
Nordika	102
Piase	122

Tele di Marmo	140
Tele di Marmo Reloaded	156
Tele di Marmo Revolution	172

45x90	
Nordika	102
On Square	108
Piase	122
Stone Box	134

15x90	
Stone Box	134
Sleek Wood	130

80x80	
Be-Square	32
Chateau	52

Kotto	80
On Square	108
Petra	116
Totalook	180

40x80	
Be-Square	32
Chateau	52

Kotto	80
Totalook	180
20x80	
Petra	116

60x60	
Anthology Marble	226
Be-Square	32
Chateau	52

Eterna	62
Kotto	80
Nordika	102
On Square	108
Petra	116
Piase	122
Totalook	180
Tracce	190

20x20	
20Twenty	20
Be-Square	32
Brixen Stone	46
Externa	68
Externa Cotto	72
Externa Quarzite	76

11x54 (Chevron)	
Sleek Wood	130

30x60	
Anthology Stone	26
Be-Square	32
Brixen Stone	46
Chateau	52
Eterna	62
Kotto	80
Nordika	102
On Square	108
Petra	116
Piase	122
Stone Box	134
Tele di Marmo	140
Tele di Marmo Reloaded	156
Tele di Marmo Revolution	172
Totalook	180
Tracce	190

30x30	
Kotto	80

7,5x30	
Eterna	62
Tele di Marmo	140
Tele di Marmo Reloaded	156
Tele di Marmo Revolution	172
Totalook	180
Tracce	190

30x30	
Kotto	80

30x30	
Kotto	80

30x30	
Eterna	62
Tele di Marmo	140
Tele di Marmo Reloaded	156

20x40	
Brixen Stone	46
Externa	68
Externa Cotto	72
Externa Quarzite	76

20x20	
20Twenty	20
Be-Square	32
Brixen Stone	46
Externa	68
Externa Cotto	72
Externa Quarzite	76

11x54 (Chevron)	
Sleek Wood	130

Brick 12,5x25	
Kotto	80

Brick 6x25	
Brick Design	42
Kotto	80
Piase	122

Brick 6x24	
Totalook	180

Multiformato Mix 5	
Anthology Stone	26

50x100  20mm	
Nordika	102

40x120  20mm	
Millelegni	90
Millelegni Remake	96

45x90  20mm	
On Square	108

80x80  20mm	
Be-Square	32

Chateau	52
Totalook	180
60x60  20mm	
Be-Square	32
On Square	108
Piase	122
Totalook	180

DAL 1961 ECCELLENZA E INNOVAZIONE NELLA CERAMICA.

Dal 1961 siamo tra i leader mondiali nel settore della ceramica. Con passione e visione ideiamo, produciamo e distribuiamo in tutti i continenti materiali in gres porcellanato di qualità superlativa per 4 brand - Emilceramica, Ergon, Provenza e Viva - perpetuando e rinnovando il meglio del Made in Italy. Curiamo fin nei minimi dettagli anche le fasi di assistenza e post vendita, certi che perseguire l'eccellenza e l'innovazione in ogni singolo aspetto del nostro lavoro sia la strada maestra per soddisfare appieno i nostri clienti e rafforzare quella reputazione di partner solido, reattivo e affidabile che resta il nostro più prezioso capitale.

EXCELLENCE AND INNOVATION IN CERAMIC COVERINGS SINCE 1961

We have been a world leader in ceramic coverings since 1961. With passion and vision, we design, produce and globally distribute superlative quality porcelain stoneware materials for 4 brands - Emilceramica, Ergon, Provenza and Viva - perpetuating and renewing the best of Italian style and manufacturing.

We also take care of technical service and after-sales down to the tiniest detail, in the firm belief that pursuing excellence and innovation in every single aspect of what we do is the secret to fully satisfying our customers, and reinforcing our reputation as a sound, responsive, reliable partner: our most valuable asset.

DEPUIS 1961, EXCELLENCE ET INNOVATION EN CÉRAMIQUE

Depuis 1961, nous sommes parmi les chefs de file mondiaux dans le secteur de la céramique. Nous fabriquons et distribuons, avec passion et avec clairvoyance, sur tous les continents, un grès cérame de première qualité sous 4 marques - Emilceramica, Ergon, Provenza et Viva - en perpétuant et en modernisant le meilleur du Made in Italy.

Nous apportons aussi une très grande attention à l'assistance et à l'après-vente, parce que nous sommes d'avis que la poursuite de l'excellence et de l'innovation, à toutes les étapes de notre travail, est la seule et unique voie pour satisfaire totalement nos clients et pour consolider notre réputation de partenaire sérieux, réactif et fiable qui reste notre atout le plus précieux.

QUALITÄT UND INNOVATION IN DER KERAMIK SEIT 1961

Wir sind seit 1961 weltweit führend im Bereich Keramik. Mit Leidenschaft und visionären Ideen entwickeln und produzieren wir besonders hochwertige Feinsteinzeugmaterialien, die wir unter den 4 Markennamen Emilceramica, Ergon, Provenza e Viva in allen Kontinenten vertreiben - bestes Know-how Made in Italy.

Unser besonderes Augenmerk gilt auch dem After-Sales-Service. Wir sind davon überzeugt, dass Qualität und Innovation in jedem Detail der beste Weg ist, um die Zufriedenheit unserer Kunden zu erreichen und unseren Ruf als solider, zuverlässiger und reaktionsschneller Partner zu stärken: Dies ist und bleibt unser wertvollstes Kapital.

DESDE 1961 EXCELENCIA E INNOVACIÓN EN LA CERÁMICA

Desde 1961 estamos entre las empresas punteras del mundo entero en el sector de la cerámica. Con entusiasmo y visión de futuro ideamos, producimos y distribuimos a todos los continentes materiales de gres porcelánico de calidad superlativa para cuatro marcas - Emilceramica, Ergon, Provenza y Viva -, perpetuando y actualizando lo mejor del Made in Italy. También cuidamos hasta el menor de los detalles los servicios de asistencia y posventa, con la seguridad de que perseguir la excelencia y la innovación en cada uno de los aspectos de nuestro trabajo es el único camino para satisfacer plenamente a nuestros clientes y reforzar la reputación de socio sólido, ágil y fiable que constituye nuestro capital más valioso.

СОВЕРШЕНСТВО И ИННОВАЦИИ В КЕРАМИКЕ С 1961 Г.

С 1961 года мы являемся мировыми лидерами в керамическом производстве.

Увлеченно и дальновидно мы разрабатываем, производим и реализуем на всех континентах планеты нашу продукцию из керамогранита высочайшего качества 4 брендов: Emilceramica, Ergon, Provenza и Viva, развивая и обновляя лучшее из Made in Italy.

Мы самым тщательным образом отслеживаем также процессы поддержки и послепродажного обслуживания, веря в то, что стремление к совершенству и инновациям в каждой отдельной сфере нашей работы является верным путем к полному удовлетворению наших клиентов и к укреплению репутации надежного, динамичного и внушающего доверие партнера, что является нашим самым ценным достоянием.



EMIL CERAMICA

TILES FOR LIFE

Da oltre 50 anni, nel punto di equilibrio più avanzato tra tradizione e innovazione, lavoriamo come partner affidabile al servizio di milioni di famiglie e consumatori in tutto il mondo, aiutandoli a mettere a fuoco i loro bisogni nel campo dei materiali ceramici da rivestimento, per poi soddisfarli a 360°. Dalla selezione delle migliori materie prime all'ideazione di prodotti eccellenti; dall'offerta di una ricchissima gamma di collezioni a un servizio post vendita estremamente efficiente: tutto è parte di uno sforzo appassionato che mette sempre al centro le persone e la qualità degli spazi in cui vivono.

TILES FOR LIFE

We have been working for over 50 years in the forefront of innovation teamed with tradition, as a reliable partner serving millions of households and consumers worldwide, helping them to pinpoint their ceramic covering needs and then satisfying them in every single aspect.

From the selection of the best raw materials to the design of outstanding products; from the offering of an amazingly rich range of collections to an extremely efficient after-sales service: all this is embraced by a passionately fulfilled mission that always puts people and the quality of their living-spaces first.

TILES FOR LIFE

Depuis plus de 50 ans, nous témoignons d'un parfait équilibre entre tradition et innovation pour être un partenaire fiable au service de millions de familles et consommateurs dans le monde entier, en les aidant à identifier le meilleur matériel céramique pour les revêtements de mur, pour aboutir à leur satisfaction totale.

Sélection des meilleures matières premières, création de produits d'excellence, très grande variété de collections, service après-vente extrêmement efficace: tout s'inscrit dans une démarche passionnée qui gravite autour des personnes et autour de la qualité de leurs espaces de vie.

TILES FOR LIFE

Seit mehr als 50 Jahren stehen wir für die ideale Verbindung von Tradition und Innovation und sind ein zuverlässiger Partner für Millionen von Familien und Verbrauchern in der ganzen Welt, die wir zielgerichtet bei der Auswahl von Keramikbelägen unterstützen und deren Anforderungen wir rundum erfüllen.

Von der Auswahl der besten Rohstoffe für hochwertige Produkte über die Konzeption eines umfangreichen Angebots an Kollektionen bis zu unserem effizienten After-Sales-Service: Wir stellen stets den Menschen und die Qualität seiner Wohnräume in den Mittelpunkt unserer Arbeit.

TILES FOR LIFE

Desde hace más de cincuenta años, en el punto de equilibrio más avanzado entre la tradición y la innovación, trabajamos como socio fiable al servicio de millones de familias y consumidores del mundo entero, ayudándolos a detectar sus necesidades en el campo de los materiales cerámicos de revestimiento, para después satisfacerlos al cien por cien. Desde la selección de las mejores materias primas hasta la concepción de productos excelentes; de la oferta de una amplísima gama de colecciones a un servicio posventa extraordinariamente eficaz: todo forma parte de un esfuerzo entusiasta que se centra en las personas y en la calidad de los espacios en los que viven.

TILES FOR LIFE

Более 50 лет мастерски балансируя между традициями и инновацией, мы выступаем в качестве надежного партнера на службе миллионов семей и потребителей во всем мире, помогая им определить их потребности в области керамических облицовочных материалов и удовлетворяя их на 100%. От отбора наилучшего сырья до разработки совершенной продукции, от предложения богатой линейки коллекций до чрезвычайно эффективного послепродажного обслуживания - все это является результатом труда и увлеченности, всегда ставящих в центр внимания людей и качество пространства, в котором они живут.

UNI EN ISO 9001:2015
UNI EN ISO 14001:2015
BS OHSAS 18001:2007
UNI CEI EN ISO 50001:2018



SISTEMI DI GESTIONE
CERTIFICATI



CERTIQUALITY
È MEMBRO DELLA
FEDERAZIONE CISQ

SISTEMA DI GESTIONE INTEGRATO

Emilgroup eccelle nel settore ceramico anche grazie al proprio Sistema di Gestione Integrato aziendale in materia di Qualità, Ambiente & Energia, Salute e Sicurezza dei Lavoratori. Una prova tangibile dell'impegno massimo e costante che il gruppo dedica, con approccio proattivo, a queste fondamentali tematiche: viene garantito l'assoluto rispetto degli standard più elevati in tutte le fasi del ciclo di vita del prodotto, a tutela delle parti coinvolte nel contesto in cui Emilgroup opera. Un sistema di gestione integrato che consolida e accresce la competitività del gruppo sul mercato.

Grazie all'integrazione e certificazione dei quattro sistemi di gestione

- QUALITÀ
- AMBIENTE
- ENERGIA
- SALUTE & SICUREZZA DEI LAVORATORI,

Emilgroup è stata premiata con il "GOLD EXCELLENCE AWARD", riconoscimento di eccellenza gestionale che l'istituto di certificazione CERTIQUALITY conferisce alle aziende particolarmente virtuose.

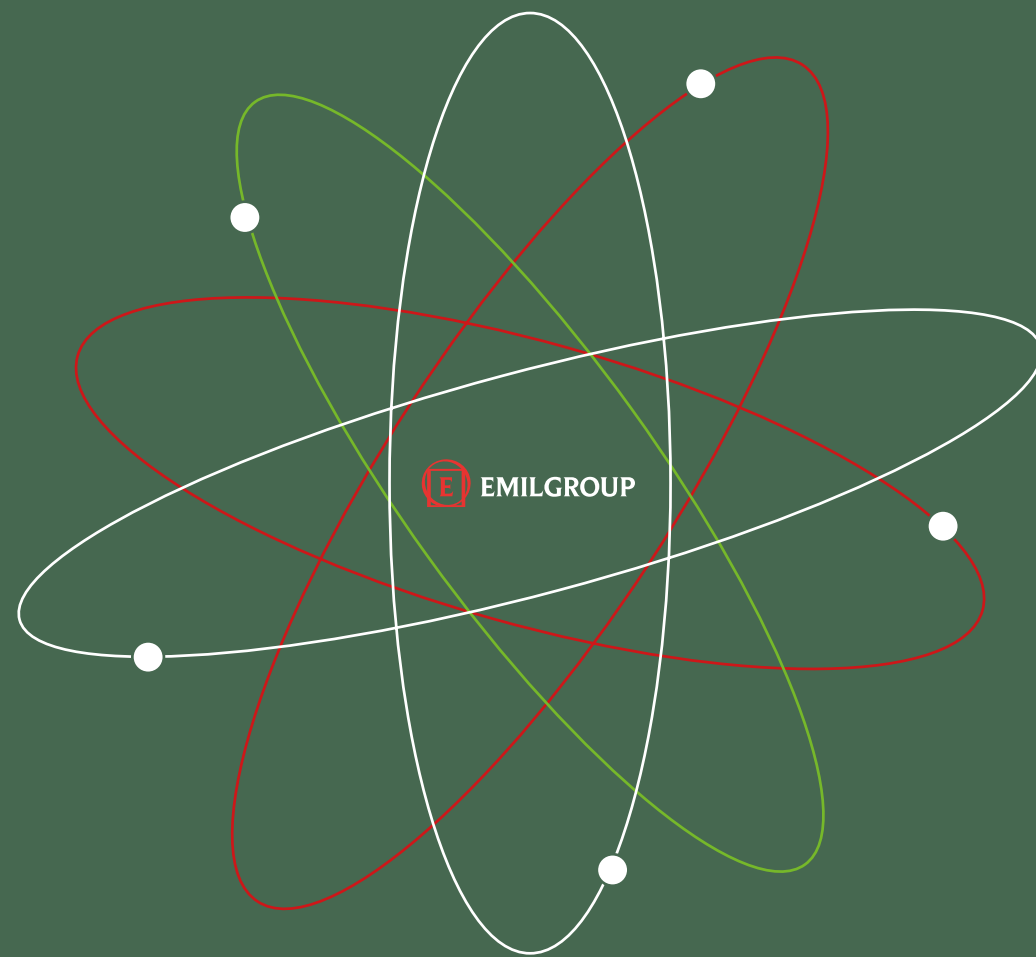

SISTEMA DI GESTIONE INTEGRATO

INTEGRATED MANAGEMENT SYSTEM

Emilgroup's excellence in the ceramics sector is supported by the certification it possesses for its Integrated Management System in the area of Quality, the Environment & Energy, and Occupational Health and Safety. Tangible proof of the significant and constant commitment the group dedicates, with its proactive approach, to these essential themes: complete respect for the highest standards is guaranteed in all phases of the product life cycle, thus protecting the various parties involved in the context in which Emilgroup operates. An integrated management system that consolidates and strengthens the group's competitiveness on the market.

Thanks to the integration and certification of its three management systems (QUALITY - ENVIRONMENT & ENERGY- OCCUPATIONAL HEALTH AND SAFETY) Emilgroup has received the "GOLD EXCELLENCE AWARD" for managerial excellence assigned by the CERTIQUALITY certification institute to companies which excel in this field.

SYSTÈME DE GESTION INTÉGRÉ

Dans le secteur céramique, Emilgroup se distingue aussi par son Système de Management Intégré en matière de Qualité, d'Environnement, d'Énergie, de Santé et Sécurité au travail. Il s'agit-là d'une preuve tangible de l'engagement constant que le groupe montre, par une démarche proactive, en faveur de ces sujets primordiaux. En effet, Emilgroup respecte les normes les plus strictes à toutes les étapes du cycle de vie du produit pour protéger toutes les parties prenantes. Un système de management intégré qui renforce et affirme la compétitivité du groupe sur le marché.

En intégrant et en certifiant ses trois systèmes de management - QUALITÉ - ENVIRONNEMENT ET ÉNERGIE - SANTÉ ET SÉCURITÉ AU TRAVAIL, Emilgroup s'est vu remettre le « GOLD EXCELLENCE AWARD », un certificat témoignant de l'excellence en management que l'organisme de certification CERTIQUALITY décerne aux entreprises particulièrement vertueuses.

INTEGRIERTES MANAGEMENT SYSTEM

Die Emilgroup ist im Rahmen eines Integrierten Managementsystems in den Bereichen Qualität, Umweltschutz und Energie sowie Gesundheitsschutz und Sicherheit der Arbeitnehmer besonders gut aufgestellt. Über den gesamten Lebenszyklus der Produkte gewährleistet sie die höchsten Standards zum Schutz aller Nutzer und Beteiligten in ihrem Geschäftsumfeld. Damit stellt sie deutlich ihr fortwährend maximales und proaktives Engagement zu diesen Themen unter Beweis. Das Integrierte Managementsystem konsolidiert und steigert die Wettbewerbsfähigkeit der Gruppe auf dem Markt. Für die Integration und Zertifizierung der Managementsysteme in den drei Bereichen QUALITÄT, UMWELTSCHUTZ UND ENERGIE sowie GESUNDHEITSSCHUTZ UND SICHERHEIT DER ARBEITNEHMER erhielt die Emilgroup den GOLD EXCELLENCE AWARD, den die Zertifizierungsstelle CERTIQUALITY besonders vorbildlichen Unternehmen verleiht.

SISTEMA DE GESTIÓN INTEGRADO

Emilgroup destaca en el sector cerámico en parte gracias a su Sistema de Gestión Integrado en materia de Calidad, Medio Ambiente y Energía, Salud y Seguridad de los Trabajadores. Una prueba tangible del esfuerzo máximo y constante que el grupo realiza, con una actitud proactiva, en relación con estos asuntos fundamentales es que se garantiza una total observación de los estándares más elevados en todas las fases del ciclo de vida del producto, con el fin de salvaguardar a las partes implicadas en el contexto en el que opera Emilgroup. Un sistema de gestión integrado que consolida y potencia la competitividad del grupo en el mercado.

Gracias a la integración y certificación de los tres sistemas de gestión (CALIDAD, MEDIO AMBIENTE Y ENERGÍA, SALUD Y SEGURIDAD DE LOS TRABAJADORES), Emilgroup ha recibido el premio "GOLD EXCELLENCE AWARD", galardón de excelencia en la gestión que el organismo de certificación CERTIQUALITY otorga a empresas especialmente virtuosas.

ИНТЕГРИРОВАННАЯ СИСТЕМА МЕНЕДЖМЕНТА

Emilgroup является лидером в керамической отрасли также благодаря своей интегрированной корпоративной системе менеджмента в сфере качества, окружающей среды и энергоэффективности, охраны здоровья и безопасности работников. Это - весомое доказательство наивысших усилий и непрерывного внимания, которое группа в профилактических целях уделяет этим вопросам. Таким образом, гарантируется полное соблюдение самых высоких стандартов на всех этапах жизненного цикла продукции, в защиту всех сторон, вовлеченных в сферу, в которой работает Emilgroup. Интегрированная система менеджмента, укрепляющая и повышающая компетенцию группы на рынке.

Благодаря интеграции и сертификации трех систем менеджмента КАЧЕСТВА, ОКРУЖАЮЩЕЙ СРЕДЫ И ЭНЕРГОЭФФЕКТИВНОСТИ, А ТАКЖЕ ЗДОРОВЬЯ И БЕЗОПАСНОСТИ РАБОТНИКОВ, Emilgroup был присужден приз "GOLD EXCELLENCE AWARD", являющийся признанием совершенства в управлении, которым сертификационный институт CERTIQUALITY награждает особенно отличившиеся компании.

QUALITÀ

Nel 1997 Emilgroup ha certificato il proprio sistema di gestione per la QUALITÀ implementato secondo la norma ISO 9001. Il principio guida di tutte le attività aziendali è la soddisfazione delle esigenze della sua clientela con prodotti dal design innovativo e dagli standard qualitativi affidabili, ottenuti attraverso il miglioramento continuo di prodotti e processi.

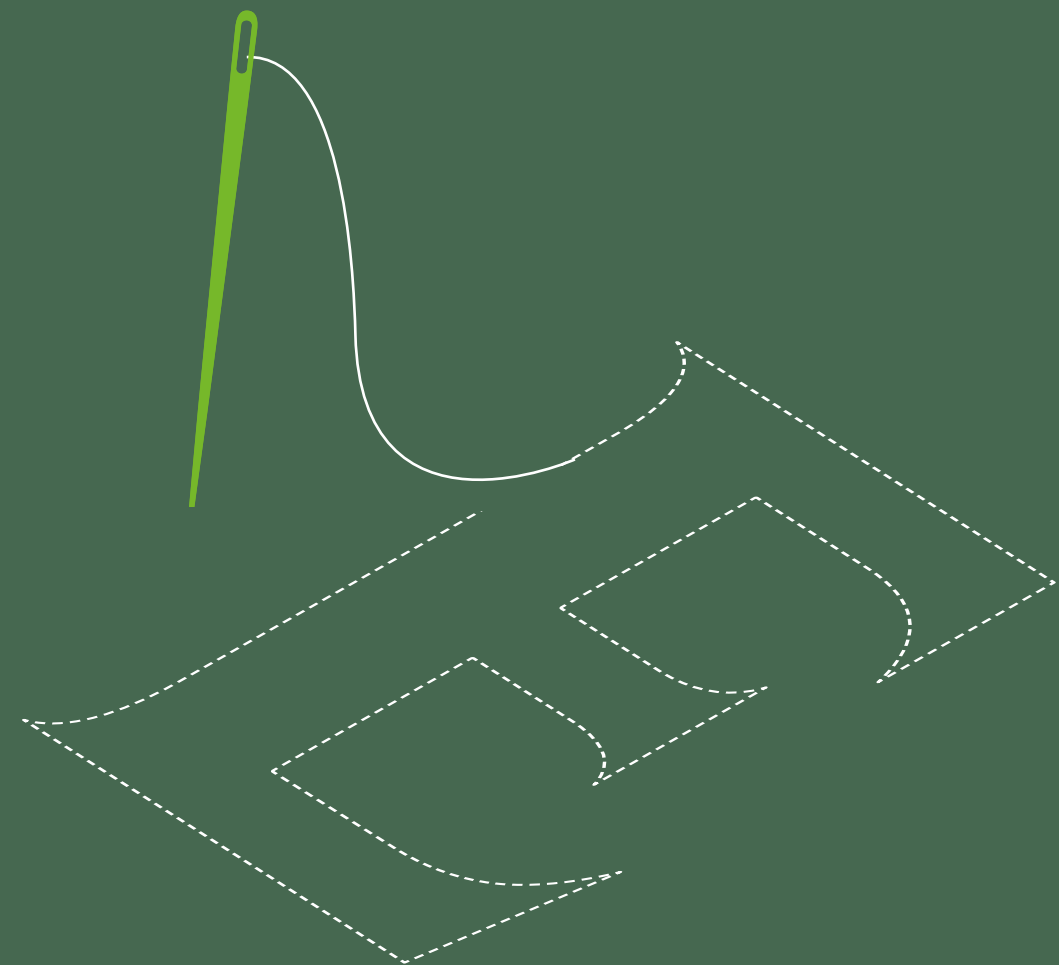

SISTEMA DI GESTIONE INTEGRATO

QUALITY

In 1997 Emilgroup certified its QUALITY management system implemented according to the ISO 9001 standard. The company's guiding principle is the satisfaction of its customers' needs with products of innovative design that have been certified according to reliable quality standards, the result of continuous improvements to its processes and products.

QUALITÉ

En 1997, Emilgroup a certifié son système de management de la QUALITÉ selon la norme ISO 9001. Dans toutes ses activités, le groupe a pour objectif la satisfaction de sa clientèle en lui proposant des produits novateurs et conformes à des normes de qualité fiables, obtenus par l'optimisation continue des produits et des process.

QUALITÄT

1997 erlangte die Emilgroup die Zertifizierung ihres Qualitätsmanagementsystems nach der Norm ISO 9001. Aufbauend auf die kontinuierliche Verbesserung von Produkten und Prozessen sind alle Tätigkeiten darauf ausgerichtet, den Kundenbedürfnissen mit innovativem Design und zuverlässigen Qualitätsstandards gerecht zu werden.

CALIDAD

En 1997 Emilgroup certificó su sistema de gestión en pro de la CALIDAD implementado de acuerdo con la norma ISO 9001. El principio que guía todas las actividades de la empresa es la satisfacción de las exigencias de su clientela con productos de diseño innovador y con estándares cualitativos fiables, alcanzados gracias a la mejora continua de los productos y los procesos.

КАЧЕСТВО

В 1997 году Emilgroup сертифицировала свою систему менеджмента КАЧЕСТВА, созданную в соответствии со стандартом ISO 9001. Руководящим принципом любой корпоративной деятельности является удовлетворение потребностей своих клиентов продукцией с инновационным дизайном, достоверными характеристиками качества, полученными путем непрерывного совершенствования продукции и производственных процессов.

SALUTE E SICUREZZA DEI LAVORATORI

Emilgroup oltre a rispettare scrupolosamente quanto previsto dalla legislazione vigente in materia di salute e sicurezza sul lavoro, rafforza ed estende a 360° il proprio impegno, adottando i requisiti aggiuntivi previsti dalla norma BS OHSAS 18001.

Nel 2014 ha conseguito la certificazione del proprio Sistema di Gestione per la Salute e la Sicurezza dei lavoratori.



SISTEMA DI GESTIONE INTEGRATO

OCCUPATIONAL HEALTH AND SAFETY

As well as scrupulously respecting the provisions of the relevant occupational health and safety legislation, Emilgroup strengthens and extends its commitment across the board, adopting the additional requisites of the BS OHSAS 18001 standard. In 2014 it received certification for its Occupational Health and Safety Management System.

SANTÉ ET SÉCURITÉ AU TRAVAIL

Outre le respect scrupuleux des dispositions réglementaires en matière de santé et sécurité au travail, Emilgroup renforce et fortifie son engagement en remplissant les critères supplémentaires de la norme BS OHSAS 18001. En 2014, Emilgroup a obtenu la certification de son système de management pour la santé et la sécurité au travail.

GESUNDHEITSSCHUTZ UND SICHERHEIT DER ARBEITNEHMER

Neben der strengen Erfüllung der geltenden Gesetzesanforderungen zum Arbeits- und Gesundheitsschutz verstärkt und erweitert die Emilgroup ihr Engagement in diesem Bereich durch die Erfüllung der zusätzlichen Anforderungen gemäß der Norm BS OHSAS 18001. Im Jahr 2014 erlangte sie die Zertifizierung ihres Arbeits- und Gesundheitsschutzmanagementsystems.

SALUD Y SEGURIDAD DE LOS TRABAJADORES

Emilgroup, además de cumplir escrupulosamente con todo lo previsto por la legislación vigente en materia de salud y seguridad en el trabajo, refuerza y amplía al máximo su compromiso adoptando los requisitos adicionales previstos en la norma BS OHSAS 18001. Además, en 2014, obtuvo la certificación de su Sistema de Gestión en pro de la Salud y la Seguridad de los trabajadores.

ЗДОРОВЬЕ И БЕЗОПАСНОСТЬ РАБОТНИКОВ

Помимо строгого соблюдения требований действующего законодательства в области здоровья и безопасности труда, Emilgroup полномасштабно укрепляет и расширяет свои усилия, выполняя дополнительные требования, предусмотренные стандартом BS OHSAS 18001. В 2014 году она получила сертификат системы менеджмента охраны здоровья и безопасности трудящихся.

ENERGIA

Nel 2016 Emilgroup ha certificato il proprio Sistema di Gestione dell'Energia implementato secondo la norma ISO 50001, segno tangibile del proprio impegno quotidiano per un uso dell'energia consapevole, attento e responsabile.

SISTEMA DI GESTIONE INTEGRATO

ENERGY

In 2016 Emilgroup certified its Energy Management System implemented according to the ISO 50001 standard, tangible proof of its daily commitment to the informed, attentive and responsible use of energy.

ÉNERGIE

En 2016, Emilgroup a certifié son système de management de l'énergie selon la norme ISO 50001, prouvant ainsi son engagement quotidien en faveur d'une gestion de l'énergie consciencieuse, attentive et responsable.

ENERGIE

2016 erlangte die Emilgroup die Zertifizierung ihres Energiemanagementsystems nach ISO 50001, die ihr tägliches Engagement für einen umweltfreundlichen, ressourcenschonenden und verantwortungsvollen Energieverbrauch würdigt.

ENERGÍA

En 2016 Emilgroup certificó su Sistema de Gestión de la Energía, implementado de conformidad con la norma ISO 50001, signo tangible de su compromiso cotidiano en pro de un uso de la energía consciente, diligente y responsable.

ЭНЕРГОЭФФЕКТИВНОСТЬ

В 2016 году Emilgroup сертифицировала свою систему энергетического менеджмента, созданную в соответствии со стандартом ISO 50001, которая является весомым доказательством своих ежедневных усилий в области осознанного, внимательного и ответственного использования энергии.

AMBIENTE

Nel 2011 Emilgroup ha certificato il proprio sistema di gestione ambientale implementato secondo la norma ISO 14001. In un'ottica globale di "life cycle perspective", l'azienda è quotidianamente impegnata nella definizione di prodotti e processi volti a ridurre costantemente l'impatto ambientale, adottando un approccio trasparente, collaborativo e previdente.

ENVIRONMENT

In 2011 Emilgroup certified its environmental management system implemented according to the ISO 14001 standard. Adopting a "life cycle perspective", the company is committed, on a daily basis, to developing products and processes with an increasingly reduced environmental impact, with an approach based on transparency, cooperation and prevention.

ENVIRONNEMENT

En 2011, Emilgroup a certifié son système de management environnemental selon la norme ISO 14001. Dans une optique globale de « perspective de cycle de vie », le groupe s'engage tous les jours à mettre au point des produits et des process qui réduisent l'impact sur l'environnement, en adoptant une démarche transparente, collaborative et prévoyante.

UMWELTSCHUTZ

2011 wurde das Umweltmanagement der Emilgroup nach den Richtlinien der ISO 14001 zertifiziert. Unter dem ganzheitlichen Ansatz der Lebenszyklusperspektive arbeitet das Unternehmen transparent, kollaborativ und vorausschauend an der Entwicklung von nachhaltigen Produkten und Prozessen.

MEDIO AMBIENTE

En 2011 Emilgroup certificó su sistema de gestión medioambiental implementado de conformidad con la norma ISO 14001. Con arreglo a un enfoque global de ciclo de vida la empresa se esfuerza día tras día en la definición de productos y procesos orientados a reducir constantemente el impacto medioambiental, adoptando un planteamiento transparente, previsor y de colaboración.

ОКРУЖАЮЩАЯ СРЕДА

В 2011 году Emilgroup сертифицировала свою систему экологического менеджмента, созданную в соответствии со стандартом ISO 14001. В плане «перспективы жизненного цикла» компания ежедневно работает над разработкой продукции и производственных процессов, нацеленных на непрерывное снижение воздействия на окружающую среду, используя для этого прозрачный, коллективный и предусмотрительный подход.

RESPONSABILITÀ

La politica aziendale di Emilgroup è da sempre basata sul rispetto dell'ambiente. Durante gli anni l'azienda si è impegnata a concretizzare progetti di salvaguardia ambientale con l'obiettivo di ridurre l'impatto di prodotti e processi attraverso i seguenti interventi:



RICICLO COMPLETO DELLE ACQUE REFLUE

Dal 1982 Emilceramica è stata una delle prime aziende del settore ad instaurare un ciclo chiuso delle acque. Tali acque provenienti dagli stabilimenti produttivi, dopo essere state depurate con trattamenti chimico-fisici vengono integralmente riciclate.



RICICLO TOTALE DEGLI SCARTI DI LAVORAZIONE E FANGHI

Dal 1989 Emilceramica riutilizza all'interno dei suoi impasti tutti gli scarti crudi di lavorazione e i fanghi ceramici, grazie ad una autorizzazione, concessa allora in via sperimentale.



AUTOPRODUZIONE DI ENERGIA ELETTRICA CON IMPIANTO DI COGENERAZIONE

Dal 1992 Emilceramica si è dotata di un impianto di cogenerazione per l'autoproduzione di energia elettrica.



MATERIALI COMPLETAMENTE RICICLABILI PER IMBALLAGGI

Dal 2000 Emilceramica impiega materiali completamente riciclabili per imballaggi, carta, fustelle, plastica dei cappucci e palette in legno.



ANALISI DEL CICLO DI VITA (LCA)

Dal 2012: analisi del ciclo di vita delle piastrelle in ceramica da pavimento e rivestimento per definire l'impronta di carbonio.

Dal 2013: LCA dei prodotti Emilceramica ottiene da Certiquality, l'Attestazione di Conformità ai requisiti delle norme UNI EN ISO 14044 e UNI EN ISO 14040.



EPD

Redazione delle EPD - ENVIRONMENTAL PRODUCT DECLARATION

EPD è la comunicazione trasparente degli impatti ambientali dei prodotti, dall'estrazione delle materie prime di cui sono composti alla dismissione a fine vita con recupero o smaltimento.



Dal 2008 il gruppo Emilceramica è membro del Green Building Council americano (USGBC).



Dal 2010 è inoltre socio del Green Building Council Italia (GBC Italia) dei quali recepisce e condivide i regolamenti, realizzando serie di prodotti in accordo con i principi di sostenibilità ambientale.

Tale sostenibilità si esprime anche attraverso la certificazione LEED (Leadership in Energy and Environmental Design), che è un sistema per la certificazione della sostenibilità edilizia sviluppata dal USGBC (US Green Building Council) ed introdotta negli stati uniti nel 1999. La certificazione LEED non è una certificazione di prodotto, ma una certificazione che valuta e attesta la sostenibilità ambientale, sociale ed economica degli edifici dalla fase di progettazione fino alla gestione quotidiana.

Tutti i prodotti Emilceramica possono contribuire all'ottenimento di almeno un credito LEED.

RESPONSIBILITY Emilgroup corporate policy has always been based on respect for the environment. Over the years, the company has implemented genuine environmental protection projects, with the aim of reducing the environmental impact of products and processes. These have included:

RESPONSABILITÉ Depuis toujours, Emilgroup base sa politique sur le respect de l'environnement. Au fil des ans, la société s'est engagée à concrétiser des projets de protection environnementale, dans le but de réduire l'impact de ses produits et de ses procédés comme suit:

VERANTWORTUNG Die Unternehmenspolitik von Emilgroup basiert seit jeher auf dem Umweltschutz. Das Unternehmen verwirklichte daher die folgenden Projekte, die auf die Erhaltung der Umwelt abzielen und die Umweltbelastung der Produkte und Prozesse senken:

RESPONSABILIDAD La política empresarial de Emilgroup se ha basado siempre en el respeto por el medio ambiente. A lo largo de los años la empresa se ha esforzado por llevar a cabo proyectos de salvaguardia medioambiental con el objeto de reducir el impacto de sus productos y procesos de fabricación. Dan prueba de ello las acciones que ha ido realizando:

ОТВЕТСТВЕННОСТЬ Корпоративная политика Emilgroup всегда основывалась на защите окружающей среды. За годы работы компания реализовала проекты охраны природы, целью которых являлось снижение воздействия продукции и производственных процессов на окружающую среду посредством следующих мероприятий:

COMPLETE WASTEWATER RECYCLING
In 1982 Emilceramica became one of the first companies in the industry to establish a closed water cycle. After chemical-physical treatment, all wastewater from the production plants is reused.

RECYCLAGE TOTAL DES EAUX USÉES
En 1982, Emilceramica se place parmi les premières sociétés du secteur à mettre en circuit fermé les eaux de production. Après un traitement physicochimique, les eaux émises par les établissements sont réutilisées.

VOLLSTÄNDIGES ABWASSERRECYCLING
Im Jahr 1982 war Emilceramica eines der ersten Unternehmen der Keramikbranche, das einen geschlossenen Wasserkreislauf einführt. Die Abwässer der Produktionsstätten werden mit Hilfe von chemischen und physikalischen Verfahren geklärt und vollständig zurückgeführt.

RECICLAJE COMPLETO DE LAS AGUAS RESIDUALES
En 1982 Emilceramica fue una de las primeras empresas del sector en introducir un ciclo cerrado de aguas. Las aguas procedentes de las fábricas, tras ser depuradas mediante tratamientos físico-químicos, son recicladas por entero.

ПОЛНОЕ ПОВТОРНОЕ ИСПОЛЬЗОВАНИЕ СТОЧНЫХ ВОД
С 1982 года компания Emilceramica была одной из первых в отрасли, наладившей закрытый цикл использования воды. Вода, поступающая с производственных предприятий, после очистки химико-физическими процессами повторно используется в полном.

TOTAL RECYCLING OF PROCESSING WASTE AND SLUDGE
Emilceramica has been reusing unfired reject tiles and ceramic sludge in its tile body mixes since 1989, thanks to an authorisation originally granted on a trial basis.

RECYCLAGE TOTAL DES DÉCHETS DE PRODUCTION ET DES BOUES
Depuis 1989, Emilceramica réutilise, pour la réalisation de ses pâtes, l'ensemble des déchets de production non cuits, ainsi que les boues céramiques, grâce à une autorisation attribuée, à l'époque, à titre expérimental.

VOLLSTÄNDIGES RECYCLING DER PRODUKTIONSABFÄLLE UND SCHLÄMME
Dank einer spezifischen Genehmigung, die einst zu experimentellen Zwecken erteilt wurde, recycelt Emilceramica seit 1989 alle ungebrannten Produktionsabfälle und keramischen Schlämme in der Aufbereitung der Rohstoffmassen.

RECICLAJE TOTAL DE LODOS Y RESIDUOS DE FABRICACIÓN
Desde 1989 Emilceramica reutiliza, introduciéndolos en sus masas, todos los desechos crudos de fabricación y lodos cerámicos, gracias a un permiso, concedido entonces de manera experimental.

ПОЛНОЕ ПОВТОРНОЕ ИСПОЛЬЗОВАНИЕ ОТХОДОВ ПРОИЗВОДСТВА И ШЛАМА
С 1989 года Emilceramica использует в своих смесях все сырые отходы обработки и керамический шлам, что стало возможным благодаря разрешению, выданному в то время в качестве эксперимента.

PRODUCTION OF OWN ELECTRICITY WITH A COGENERATION PLANT
Emilceramica installed a cogeneration plant enabling it to produce its own electricity in 1992.

AUTONOMIE ÉLECTRIQUE PAR CENTRALE DE COGÉNÉRATION
Depuis 1992, Emilceramica produit son électricité en toute autonomie avec une centrale de cogénération.

EIGENERZEUGUNG VON ELEKTRISCHER ENERGIE MIT EINER KRAFT-WÄRME-KOPPLUNGSANLAGE
Emilceramica ist seit 1992 mit einer Kraft-Wärme-Kopplungsanlage für die Selbstversorgung mit elektrischer Energie ausgestattet.

AUTOPRODUCCIÓN DE ENERGÍA ELÉCTRICA CON SISTEMA DE COGENERACIÓN
En 1992 Emilceramica se dotó de un sistema de cogeneración para la producción de energía eléctrica propia.

АВТОНОМНОЕ ПРОИЗВОДСТВО ЭЛЕКТРОЭНЕРГИИ ПРИ ПОМОЩИ КОГЕНЕРАЦИОННОЙ СИСТЕМЫ
В 1992 году компания Emilceramica оснастилась когенерационной системой для автономного производства электроэнергии.

FULLY RECYCLABLE PACKAGING MATERIALS
Emilceramica has been using fully recyclable packaging materials: paper, cardboard boxes, pallet hood plastic and wooden pallets treated since 2000.

MATÉRIEL D'EMBALLAGE RECYCLABLE À 100%
Depuis 2000, Emilceramica utilise un matériel 100% recyclable pour les emballages, les papiers, les vignettes, le plastique des capuchons, ainsi que des palettes en bois.

VOLLSTÄNDIG RECYCELBARES VERPACKUNGSMATERIAL
Seit 2000 verwendet Emilceramica komplett recycelbares Verpackungsmaterial wie Papier, Schachteln, Kunststoffhauben und Holzpaletten.

MATERIALES DE EMBALAJE COMPLETAMENTE RECICLABLES
Desde el año 2000 Emilceramica viene empleando materiales completamente reciclables para sus embalajes, papel, troqueles, plástico de los capuchones y paletas de madera tratadas.

УПАКОВОЧНЫЕ МАТЕРИАЛЫ, ПОЛНОСТЬЮ ПОДЛЕЖАЩИЕ СДАЧЕ ВО ВТОРСЫРЬЕ
С 2000 года Emilceramica использует полностью перерабатываемое сырье для упаковок, бумагу, вырубку, обмоточную пленку и деревянные поддоны.

LIFE CYCLE ANALYSIS (LCA)
From 2012: the life cycle analysis of ceramic floor and wall tiles to define their carbon footprint. Since 2013: the LCA of Emilceramica products holds Certification of Conformity with the requirements of the UNI EN ISO 14044 and UNI EN ISO 14040 standards by Certiquality.

ANALYSE DU CYCLE DE VIE (LCA)
Depuis 2012: analyse du cycle de vie des carreaux de sol et mur en céramique pour calculer l'empreinte carbone. À partir de 2013: Certiquality décerne à l'analyse du cycle de vie (ACV) des produits Emilceramica la certification de conformité aux normes UNI EN ISO 14044 et UNI EN ISO 14040.

LEBENSZYKLUSANALYSE (LCA)
Seit 2012: Lebenszyklusanalyse der keramischen Boden- und Wandfliesen zur Bestimmung der CO2-Bilanz. Seit 2013: Ökobilanz. Emilceramica erhält von Certiquality die Bescheinigung für die Übereinstimmung mit den Normen UNI EN ISO 14044 und UNI EN ISO 14040.

ANÁLISIS DEL CICLO DE VIDA (LCA)
Desde 2012: análisis del ciclo de vida de los azulejos de cerámica para pavimento y revestimiento con el fin de determinar la huella de carbono. En 2013: la LCA de los productos Emilceramica obtiene de Certiquality el certificado de conformidad con los requisitos de las normas UNI EN ISO 14044 y UNI EN ISO 14040.

АНАЛИЗ ЖИЗНЕННОГО ЦИКЛА (LCA)
С 2012 года: анализ жизненного цикла керамической напольной и облицовочной плитки для определения ее углеродного следа. С 2013 года: ОЖЦ продукции. Emilceramica получила от организации Certiquality сертификат соответствия требованиям стандартов UNI EN ISO 14044 и UNI EN ISO 14040.

EPD
Preparation of EPDs - ENVIRONMENTAL PRODUCT DECLARATIONS. The EPD is the transparent statement of products' environmental impacts, from the extraction of the raw materials used in their manufacture to their end-of-life decommissioning with recovery or disposal.

DEP
Rédaction des DEP - DÉCLARATIONS ENVIRONNEMENTALES DE PRODUIT. Une DEP est le format de communication transparent sur les impacts environnementaux des produits, de l'extraction de leurs matières premières à leur fin de vie avec recyclage ou mise en décharge.

Umwelt-Produktdeklaration (EPD)
Erstellung der EPD ENVIRONMENTAL PRODUCT DECLARATION. Die EPD ist eine transparente Deklaration der Umweltauswirkungen der Produkte, beginnend beim Rohstoff bis hin zum Altprodukt mit Recycling/Entsorgung.

EPD
Redacción de las EPD - DECLARACIONES AMBIENTALES DE PRODUCTO. EPD es la comunicación transparente de los impactos medioambientales de los productos, desde la extracción de las materias primas que los componen hasta su retirada al final de su vida útil, con el consiguiente reciclaje o eliminación.

EPD
Составление EPD - ENVIRONMENTAL PRODUCT DECLARATION (ЭКОЛОГИЧЕСКАЯ ДЕКЛАРАЦИЯ ПРОДУКЦИИ). В EPD объективно представлено общее воздействие на окружающую среду продукции, начиная с получения составляющего ее сырья и вплоть до конца ее срока службы с последующей повторной переработкой или утилизацией.

The Emilceramica group has been a member of the USGBC (US Green Building Council) since 2008. In 2010 it also became a member of the Green Building Council Italia (GBC Italia), implementing and adopting its rules by manufacturing series of products in accordance with the principles of environmental sustainability. This sustainability is also expressed through certification under the LEED (Leadership in Energy and Environmental Design) system, a system for the certification of sustainable construction criteria developed by the USGBC (US Green Building Council) and introduced in the United States in 1999. LEED certification is not a form of product certification; it is a certification that assesses and demonstrates buildings' environmental, social and economic sustainability from the design phase through to routine management. All Emilceramica products can contribute to obtaining at least one LEED credit.

Depuis 2008, le groupe Emilceramica est membre de l'US Green Building Council (USGBC). Qui plus est, la société fait partie, depuis 2010, du Green Building Council Italia (GBC Italia), dont elle reconnaît formellement et applique les règlements, en fabriquant des produits selon les principes de la durabilité environnementale. Cette durabilité se traduit également par la certification LEED (Leadership in Energy and Environmental Design), qui atteste la durabilité des bâtiments conformément au référentiel de l'USGBC (US Green Building Council), en vigueur aux États-Unis depuis 1999. La certification LEED n'est pas une certification de produit, mais une certification qui apprécie et quantifie la durabilité environnementale, sociale et économique des bâtiments, depuis l'étude de projets jusqu'à la gestion quotidienne. Tous les produits Emilceramica peuvent contribuer à obtenir au moins l'un des crédits LEED.

Seit 2008 ist die Emilceramica Gruppe Mitglied des US-amerikanischen Green Building Council (USGBC). Im Jahr 2010 trat sie außerdem dem Green Building Council Italia (GBC Italia) bei, dessen Regelwerk sie mit der Herstellung von nachhaltigen Produkten umsetzt und teilt. Die Nachhaltigkeit spiegelt sich auch in der LEED-Zertifizierung (Leadership in Energy and Environmental Design) wider. Das Zertifizierungssystem für nachhaltiges Bauen wurde vom USGBC (US Green Building Council) entwickelt und 1999 in den USA eingeführt. Die LEED-Zertifizierung zertifiziert nicht das Produkt, sondern ist eine Zertifizierung zur Beurteilung und Bescheinigung der ökologischen, gesellschaftlichen und wirtschaftlichen Nachhaltigkeit von Gebäuden, beginnend bei der Planung bis hin zur Bewirtschaftung. Alle Emilceramica Produkte können zur Zuerkennung von mindestens einem LEED-Punkt s.o. beitragen.

Desde 2008 el grupo Emilceramica es miembro del Green Building Council estadounidense (USGBC). Desde 2010, además, es socio del Green Building Council Italia (GBC Italia) cuyos reglamentos acepta y comparte, realizando series de productos de acuerdo con los principios de sostenibilidad medioambiental. Dicha sostenibilidad se expresa asimismo a través de la certificación LEED (Leadership in Energy and Environmental Design), un sistema para la certificación de la sostenibilidad en el campo de la construcción desarrollado por el USGBC (US Green Building Council) e introducido en los Estados Unidos en 1999. La certificación LEED no es una certificación de producto, sino una certificación que evalúa y da fe de la sostenibilidad medioambiental, social y económica de los edificios desde su proyección hasta su gestión diaria. Todos los productos Emilceramica pueden contribuir a la consecución de por lo menos uno de los créditos LEED.

С 2008 года группа Emilceramica является членом американского Совета Green Building Council (USGBC). Кроме того, с 2010 года она является членом итальянского совета Green Building Council (GBC Italia), выполняя и разделяя его регламент, производя серию продукции, соответствующую принципам экологической рациональности. Эта рациональность также выражается посредством сертификата LEED (Leadership in Energy and Environmental Design), являющегося системой сертификации строительной рациональности, разработанной USGBC (US Green Building Council) и введенной в Соединенных Штатах в 1999 году. Сертификация LEED не является сертификацией продукции, а является сертификацией, оценивающей и подтверждающей экологическую, социальную и экономическую рациональность зданий, начиная с этапа проектирования, вплоть до ежедневного управления. Вся продукция Emilceramica может способствовать получению хотя бы одного из вышеуказанных кредитов LEED.

L'AMBIENTE È ANCHE TUO: AIUTACI A RISPETTARLO.

THE ENVIRONMENT IS YOURS TOO:
HELP US TO RESPECT IT.



**CONSORZI ITALIANI
PER LA RACCOLTA,
RECUPERO E RICICLAGGIO
DEGLI IMBALLAGGI**

ITALIAN PACKAGING COLLECTION,
RECOVERY AND RECYCLING CONSORTIA

RILEGNO

www.rilegno.it

Consorzio nazionale per la raccolta, il recupero ed il riciclaggio degli imballaggi in legno.
National wooden packaging collection, recovery and recycling consortium.

COREPLA

www.corepla.it

Consorzio nazionale per la raccolta, il recupero ed il riciclaggio degli imballaggi in plastica.
National plastic packaging collection, recovery and recycling consortium.

COMIECO

www.comieco.it

Consorzio nazionale per la raccolta, il recupero ed il riciclaggio degli imballaggi a base cellulosica.
National cellulose-based packaging collection, recovery and recycling consortium.

1

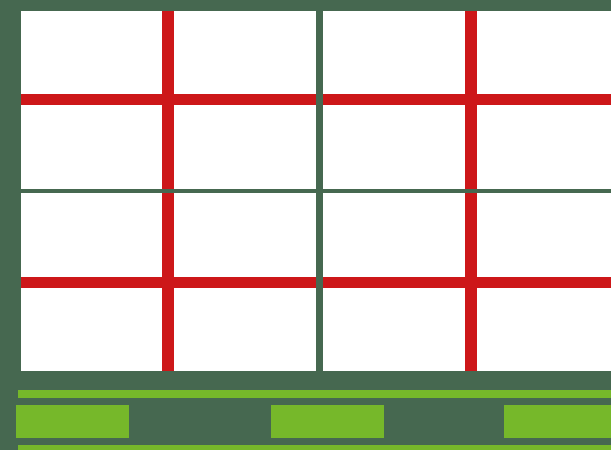

PLASTICA
PLASTIC



CAPPUCCI > Imballaggi in plastica > CER 150102

Hoods Plastic packaging CER 150102

2



PLASTICA
PLASTIC



REGGETTE > Imballaggi in plastica > CER 150102

Straps Plastic packaging CER 150102

LEGNO
WOOD



PALLETS > Imballaggi in legno > CER 150103

Pallets Wooden packaging CER 150103

3



CARTA - CARTONE
PAPER - CARDBOARD



SCATOLA > Imballaggi carta e cartone > CER 150101

Boxes Paper and cardboard packaging CER 150101

INERTE
AGGREGATES



PIASTRELLE Scarti di ceramica, mattoni, mattonelle e materiali da costruzione sottoposti a trattamento termico > CER 101208

Tiles Scraps from ceramics, brick, tiles and construction materials (subject to heat treatment) CER 101208

INERTE
AGGREGATES



PIASTRELLE/MOSAICI

Rifiuti misti dell'attività di costruzione/demolizione > CER 170904

Mosaics/Tiles Mixed construction and demolition waste CER 170904

Emilceramica è iscritta al CONAI (Consorzio Nazionale Imballaggi) CODICE SOCIO 11001608 in quanto utilizzatore di imballi.
Emilceramica aderisce al Sistema PARI (Piano per la gestione autonoma dei rifiuti di imballaggio) del CARPI (Consorzio autonomo riciclo plastiche Italia).

Emilceramica is member number 11001608 of the CONAI (National Packaging Consortium) as a user of packaging.
Emilceramica is also a member of the PARI System (Independent packaging waste management plan) of the CARPI (Italian independent plastic recycling consortium).

20TWENTY

FORMATI

Sizes | Formats | Formate | Tamaños | Форматы

 10 mm.

22,5x180 - 8^{7/8}"x70^{7/8}" Naturale

25x150 - 9^{13/16}"x59^{1/6}" Naturale

20x120 - 7^{7/8}"x47^{1/4}" Naturale

20x20 - 7^{7/8}"x7^{7/8}" Naturale

SUPERFICI

Finishes | Finitions | Oberflächen
Superficies | Отделка поверхности

■ NATURALE

R10 DIN 51130

B (A+B) DIN 51097

Wet \geq 0,50 ANSI A 137.1- 2012 DCOF (Section 9.6)

\geq 0,40 B.C.R.A.

P2 AS 4586: 2013

> 36 Low Slip potential BS 7976-2: 2002

2 ENV 12633:2006

SHADE VARIATIONS



V3 HIGH



Vintage

V4 RANDOM

DESTINAZIONI D'USO

Intended uses | Domaines d'application
Zweckbestimmung | Usos previstos | Назначение



Min. 7,5%



UPEC-D+



PALLETS WHITE



INDUSTRIAL



TRONCO

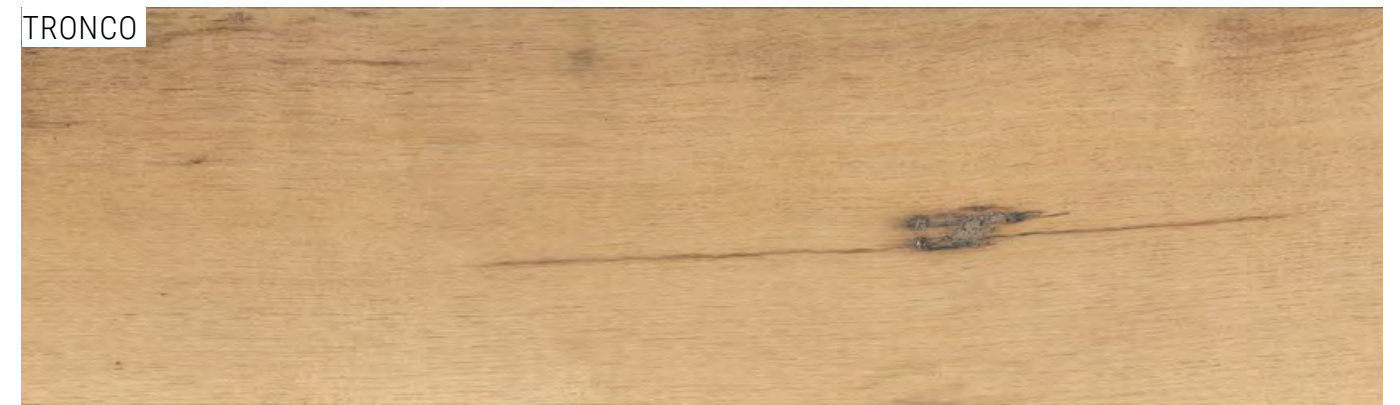

TAVOLA



VINTAGE



COLORI E FORMATI

Colours and Sizes | Couleurs et Formats | Farben und Formate | Colores y Tamaños | Цвета и Форматы

Pallets White



Industrial



Tronco



Tavola



Vintage



COLORI E FORMATI

Colours and Sizes | Couleurs et Formats | Farben und Formate | Colores y Tamaños | Цвета и Форматы



Naturale Rett.
22,5x180 - 8^{7/8}x70^{7/8}"
EGEV Pallets White ● 82
EGEW Industrial ● 82
EGEX Tronco ● 82



Naturale Rett.
25x150 - 9^{13/16}x59^{1/6}"
ECY0 Industrial U₄P₂E₃C₂D₄ ● 82
ECY1 Tronco ● 82



Naturale Rett.
20x120 - 7^{7/8}x47^{1/4}"
ECJT Pallets White ● 79
ECJU Industrial U₄P₂E₃C₂D₄ ● 79
ECJV Tronco ● 79
ECJW Tavola ● 79
ECJX Vintage ● 79











Naturale
20x20 - 7^{7/8}x7^{7/8}"
ECTL Pallets White ● 60
ECTM Industrial ● 60
ECTN Tronco ● 60

Si consiglia la posa con fuga 2 mm. - Laying with a 2 mm-joint is recommended. - Pose recommandée avec joints de 2 mm.
Es wird eine Fugenbreite von 2 mm empfohlen. - Se recomienda la colocación con juntas de 2 mm. - Рекомендуется укладка с швом 2 мм.

PEZZI SPECIALI

Trims | Pieces Speciales | Formteile | Piezas Especiales | Специальные Изделия

	Dimensione Size	 Pallets White	 Industrial	 Tronco	 Tavola	 Vintage	Fascia di prezzo Price band
 Battiscopa - Skirting	Nat. Rett. 4,6x120 - 1 ^{13/16} x47 ^{1/4} Pcs. Box. 6 - LM x Box 7,20	ECN7	ECN8	ECN9	ECNA	ECNC	● 39
 Gradino - Stair Tread	Nat. Rett. 33x120 - 12 ^{15/16} x47 ^{1/4} Pcs. Box. 2 - LM x Box 2,40	ECPA	ECPC	ECPD	ECPE	ECPF	● 90
 Gradone - Step	Nat. Rett. 33x120x3,2x3,2 12 ^{15/16} x47 ^{1/4} x1 ^{1/4} x1 ^{1/4} Pcs. Box. 2 - LM x Box 2,40	ECND	ECNE	ECNF	ECNG	ECNH	● 95
 Angolare Dx Sx Corner Tile Dx Sx	Nat. Rett. 33x120x3,2x3,2 12 ^{15/16} x47 ^{1/4} x1 ^{1/4} x1 ^{1/4} Pcs. Box. 1 - LM x Box 1,20	DX ECMX	DX ECMZ	DX ECN1	DX ECN3	DX ECN5	● 100
		SX ECMY	SX ECN0	SX ECN2	SX ECN4	SX ECN6	

IMBALLI E PESI

Packing and Weight | Emballages et Poids | Verpackung und Gewicht | Embalajes y Pesos | Упаковка и Вес

Formato Size Format Format Тamaño Формат cm	Spessore Thickness Epaisseur Stärke Espesor Толщина mm	Pz. x Mq. Pieces x Sqm Pcs / M ² Stk. x Qm Pzs x Mc. Шт x Кв.М.	Pz. x Scat. Pieces x Box Pcs / Bte Stk. x Krt. Pzs x Caja Шт x Кор.	Mq. x Scat. Sqm x Box M ² / Bte Qm x Krt. Mc. x Caja Кв.М. x Кор.	Peso x Scat. Weight x Box Poids / Bte Gewicht x Krt. Peso x Caja Вес x Кор. Kg	Scat. x Pal. Boxes x Pal. Bte / Pal. Krt. x Pal. Cajas x Pal. Кор. x Подд.	Mq. x Pal. Sqm x Pal. M ² / Pal. Qm x Pal. Mc. x Pal. Кв.М x Подд.	Peso x Pal. Weight x Pal. Poids / Pal. Gewicht x Pal. Peso x Pal. Вес x Подд. Kg
22,5x180 Naturale	10	2,47	4	1,620	41,01	36	58,32	1476
25x150 Naturale	10	2,67	3	1,125	26,75	45	50,63	1204
20x120 Naturale	10	4,17	4	0,960	22,49	40	38,40	900
20x20 Naturale	10	25,00	24	0,960	19,04	54	51,84	1028



Pallets White Nat. - 20x20 - 7^{7/8}x 7^{7/8}
Pallets White Nat. Rett. - 20x120 - 7^{7/8}x47^{1/4}

ANTHOLOGY STONE

FORMATI

Sizes | Formats | Formate | Tamaños | Форматы

10 mm.

30x60 - 11^{13/16}"x23^{5/8}" Indoor Nat. - Outdoor Nat.

MIX5 Indoor Nat. - Outdoor Nat.

SUPERFICI

Finishes | Finitions | Oberflächen
Superficies | Отделка поверхности

INDOOR NATURALE

R10 DIN 51130

A DIN 51097

Wet $\geq 0,50$ ANSI A 137.1- 2012 DCOF (Section 9.6)

$\geq 0,40$ B.C.R.A.

P2 AS 4586: 2013

> 36 Low Slip potential BS 7976-2: 2002

- ENV 12633-2006

OUTDOOR NATURALE

R11 DIN 51130

C (A+B+C) DIN 51097

Wet $\geq 0,65$ ANSI A 137.1- 2012 DCOF (Section 9.6)

$\geq 0,40$ B.C.R.A.

P3 AS 4586: 2013

> 36 Low Slip potential BS 7976-2: 2002

- ENV 12633-2006

SHADE VARIATIONS



V4 RANDOM

DESTINAZIONI D'USO

Intended uses | Domaines d'application
Zweckbestimmung | Usos previstos | Назначение



Ceramics of Italy

放射性水平A类

Min. 7,5%



GOLD



GREY



DARK GREY

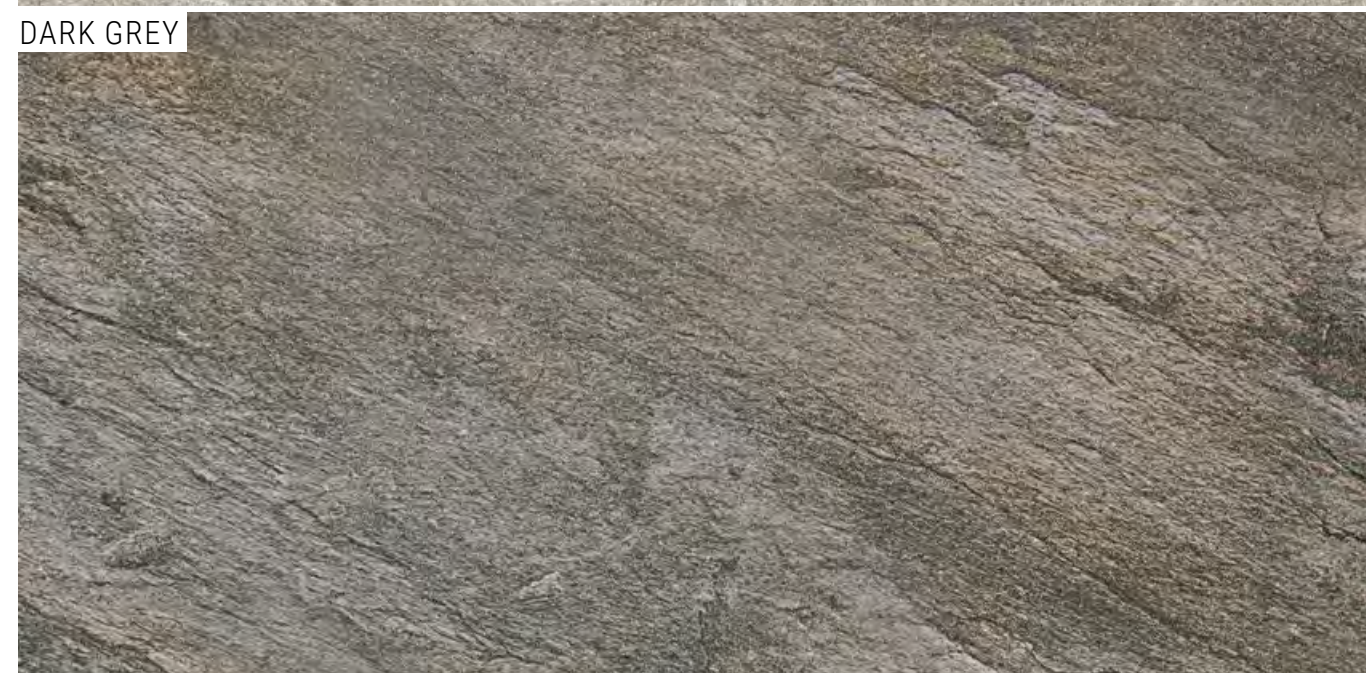

ANTHOLOGY STONE

COLORI E FORMATI

Colours and Sizes | Couleurs et Formats | Farben und Formate | Colores y Tamaños | Цвета и Форматы

Gold



Grey



Dark Grey



ANTHOLOGY STONE

COLORI E FORMATI

Colours and Sizes | Couleurs et Formats | Farben und Formate | Colores y Tamaños | Цвета и Форматы

10 mm.

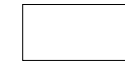

Indoor Nat. Rett.

30x60 - 11^{13/16}"x23^{5/8}"

- E1F1 Gold ● 61
- E1F2 Grey ● 61
- E1F3 Dark Grey ● 61

Outdoor Nat. Rett.

30x60 - 11^{13/16}"x23^{5/8}"

- E1FR Gold ● 61
- E1FS Grey ● 61
- E1FT Dark Grey ● 61

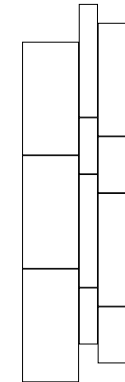

Indoor Nat. Rett.

MIX5

- E1H6 Gold ● 77
- E1H9 Grey ● 77
- E1HD Dark Grey ● 77

MIX 5

pz/pcs 3: 30x60 - 11^{13/16}"x23^{5/8}"
 pz/pcs 2: 20x60 - 7^{7/8}"x23^{5/8}"
 pz/pcs 2: 20x30 - 7^{7/8}"x11^{13/16}"
 pz/pcs 2: 10x60 - 3^{15/16}"x23^{5/8}"
 pz/pcs 2: 10x30 - 3^{15/16}"x11^{13/16}"

Outdoor Nat. Rett.

MIX5

- E1H7 Gold ● 77
- E1HA Grey ● 77
- E1HE Dark Grey ● 77

MIX 5

pz/pcs 3: 30x60 - 11^{13/16}"x23^{5/8}"
 pz/pcs 2: 20x60 - 7^{7/8}"x23^{5/8}"
 pz/pcs 2: 20x30 - 7^{7/8}"x11^{13/16}"
 pz/pcs 2: 10x60 - 3^{15/16}"x23^{5/8}"
 pz/pcs 2: 10x30 - 3^{15/16}"x11^{13/16}"

Si consiglia la posa con fuga 2 mm. - Laying with a 2 mm-joint is recommended. - Pose recommandée avec joints de 2 mm.
 Es wird eine Fugenbreite von 2 mm empfohlen. - Se recomienda la colocación con juntas de 2 mm. - Рекомендуются укладка с швом 2 мм.

ANTHOLOGY STONE

DECORI

Decors | Decors | Dekore | Decorados | Декоры

MOSAICO*

Tessera - Chip 2,8x2,8 - 1¹/₈"x1¹/₈"



30x30 - 11¹³/₁₆"x11¹³/₁₆"

E1GZ Gold Indoor Nat. ● 99



30x30 - 11¹³/₁₆"x11¹³/₁₆"

E1H0 Grey Indoor Nat. ● 99

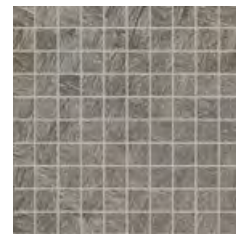

30x30 - 11¹³/₁₆"x11¹³/₁₆"

E1H1 Dark Grey Indoor Nat. ● 99

LISTELLI SFALSATI*



30x60 - 11¹³/₁₆"x23⁵/₈"

E1H5 Gold Indoor Nat. ● 87



30x60 - 11¹³/₁₆"x23⁵/₈"

E1H8 Grey Indoor Nat. ● 87

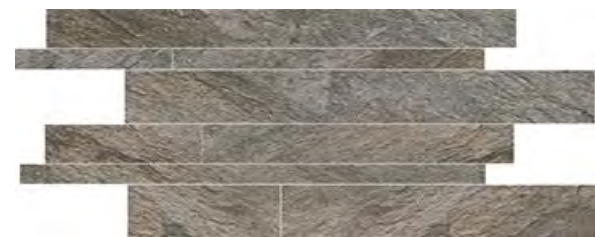

30x60 - 11¹³/₁₆"x23⁵/₈"







E1HC Dark Grey Indoor Nat. ● 87

* Su rete in fibra - On fibre mesh backing - Sur filet en fibre de verre - Auf Glasfasernetz - Sobre malla de fibra - На волоконной сетке

ANTHOLOGY STONE

PEZZI SPECIALI

Trims | Pieces Speciales | Formteile | Piezas Especiales | Специальные Изделия

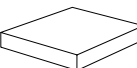
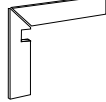
	Dimensione Size				Fascia di prezzo Price band			
 Battiscopa - Skirting	Indoor Nat. Rett. 7x60 - 2 ³ / ₄ "x23 ⁵ / ₈ " Pcs. Box 14 - LM x Box 8,40	E1QF	E1QG	E1QH	● 13			
 Elemento A "L" L Shaped Piece	Outdoor Nat. Rett. 15x30x4,5 5 ⁷ / ₈ "x11 ¹³ / ₁₆ "x1 ³ / ₄ " Pcs. Box 6 - LM x Box 1,80	E1HP	E1HQ	E809	● 24			
 Gradone - Step	Indoor Nat. Rett. 30x60x3,2x3,2 11 ¹³ / ₁₆ "x23 ⁵ / ₈ "x1 ¹ / ₄ "x1 ¹ / ₄ " Pcs. Box 4 - LM x Box 2,40	E8LQ	E8LS	E8LU	● 68			
	Outdoor Nat. Rett. 30x60x3,2x3,2 11 ¹³ / ₁₆ "x23 ⁵ / ₈ "x1 ¹ / ₄ "x1 ¹ / ₄ " Pcs. Box 4 - LM x Box 2,40	E8LR	E8LT	E8LV	● 68			
 Angolare - Corner Tile	Indoor Nat. Rett. 30x30x3,2x3,2 11 ¹³ / ₁₆ "x11 ¹³ / ₁₆ "x1 ¹ / ₄ "x1 ¹ / ₄ " Pcs. Box 2 - LM x Box 0,60	E8LX	E8LZ	E8M1	● 73			
	Outdoor Nat. Rett. 30x30x3,2x3,2 11 ¹³ / ₁₆ "x11 ¹³ / ₁₆ "x1 ¹ / ₄ "x1 ¹ / ₄ " Pcs. Box 2 - LM x Box 0,60	E8LY	E8M0	E8M2	● 73			
 Battiscopa Scala Dx Sx Tread Skirting Dx Sx	Indoor Nat. Rett. 7x60x60 - 2 ³ / ₄ "x23 ⁵ / ₈ "x23 ⁵ / ₈ " Pcs. Box 2 - LM x Box 1,20	DX E73J	SX E1V5	DX E73K	SX E73L	DX E841	SX E842	● 42

IMBALLI E PESI

Packing and Weight | Emballages et Poids | Verpackung und Gewicht | Embalajes y Pesos | Упаковка и Вес

Formato Size Format Format Tamaño Формат cm	Spessore Thickness Epaisseur Stärke Espesor Толщина mm	Pz. x Mq. Pieces x Sqm Pcs / M ² Stk. x Qm Pzs x Mc. Шт x Кв.М.	Pz. x Scat. Pieces x Box Pcs / Bte Stk. x Krt. Pzs x Caja Шт x Кор.	Mq. x Scat. Sqm x Box M ² / Bte Qm x Krt. Mc. x Caja Кв.М. x Кор.	Peso x Scat. Weight x Box Poids / Bte Gewicht x Krt. Peso x Caja Вес x Кор. Kg	Scat. x Pal. Boxes x Pal. Bte / Pal. Krt. x Pal. Cajas x Pal. Кор. x Подд.	Mq. x Pal. Sqm x Pal. M ² / Pal. Qm x Pal. Mc. x Pal. Кв.М x Подд.	Peso x Pal. Weight x Pal. Poids / Pal. Gewicht x Pal. Peso x Pal. Вес x Подд. Kg
30x60 Naturale	10	5,56	6	1,080	23,31	40	43,20	932
Mix 5 Naturale	10	-	11	1,080	21,50	32	34,56	688
30x60 Listelli Sfalsati	10	5,56	4	0,720	16,00	30	21,60	480
30x30 Mosaico	10	11,11	5	0,450	10,70	60	27,00	642

BE-SQUARE

FORMATI

Sizes | Formats | Formate | Tamaños | Форматы

6,5 mm.	120x240 - 47 ^{1/4} "x94 ^{1/2} " Nat.
	120x120 - 47 ^{1/4} "x47 ^{1/4} " Nat.
10 mm.	60x120 - 23 ^{5/8} "x47 ^{1/4} " Nat.
	60x60 - 23 ^{5/8} "x23 ^{5/8} " Nat. - Lapp.
	30x60 - 11 ^{13/16} "x23 ^{5/8} " Nat.
	80x80 - 31 ^{1/2} "x31 ^{1/2} " Nat. - Lapp.
	40x80 - 15 ^{3/4} "x31 ^{1/2} " Nat.
20MM	20x20 - 7 ^{7/8} "x7 ^{7/8} " Nat.
	80x80 - 31 ^{1/2} "x31 ^{1/2} " Nat.
	60x60 - 23 ^{5/8} "x23 ^{5/8} " Nat.

SUPERFICI

Finishes | Finitions | Oberflächen
Superficies | Отделка поверхности

NATURALE

R10 DIN 51130
B (A+B) DIN 51097
Wet \geq 0,50 ANSI A 137.1- 2012 DCOF (Section 9.6)
 \geq 0,40 B.C.R.A.
P2 AS 4586: 2013
< 36 Moderate Slip potential BS 7976-2: 2002
- ENV 12633-2006

LAPPATO

- DIN 51130
- DIN 51097
Wet \geq 0,42 ANSI A 137.1- 2012 DCOF (Section 9.6)
 \geq 0,40 B.C.R.A.
- AS 4586: 2013
- BS 7976-2: 2002
- ENV 12633-2006

20MM

R11 DIN 51130
C (A+B+C) DIN 51097
Wet \geq 0,65 ANSI A 137.1- 2012 DCOF (Section 9.6)
 \geq 0,40 B.C.R.A.
P3 AS 4586: 2013
> 36 Low Slip potential BS 7976-2: 2002
3 ENV 12633-2006

SHADE VARIATIONS



V3 HIGH

DESTINAZIONI D'USO

Intended uses | Domaines d'application
Zweckbestimmung | Usos previstos | Назначение

NATURALE - 20MM



LAPPATO



IVORY



SAND

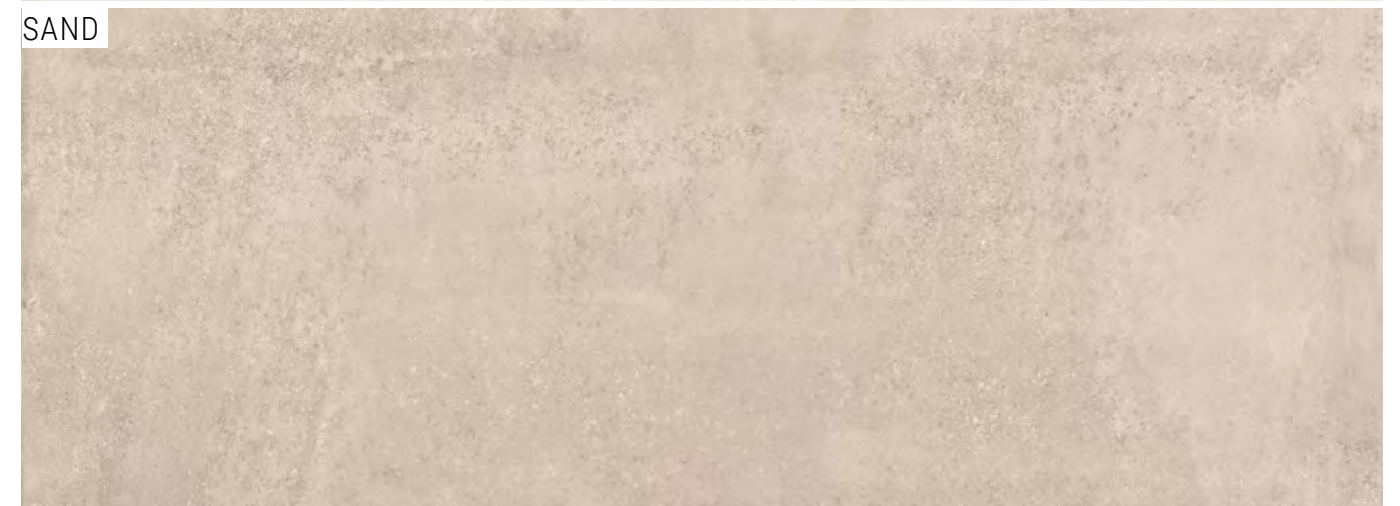

CONCRETE



BLACK

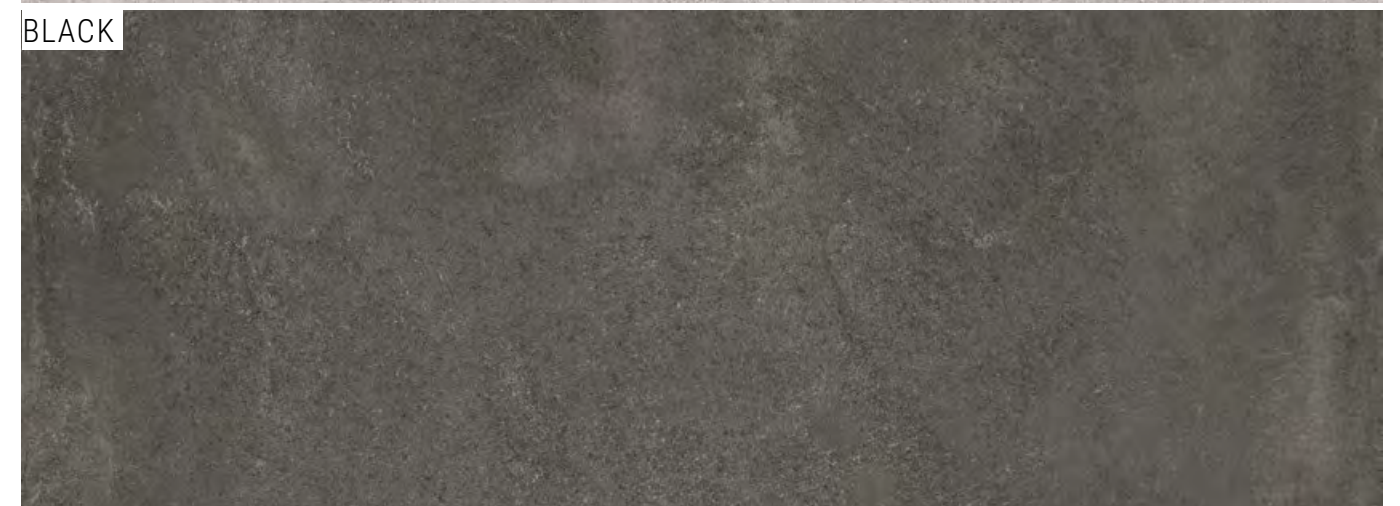

BE-SQUARE

COLORI E FORMATI

Colours and Sizes | Couleurs et Formats | Farben und Formate | Colores y Tamaños | Цвета и Форматы

Ivory



Sand



Concrete



Black

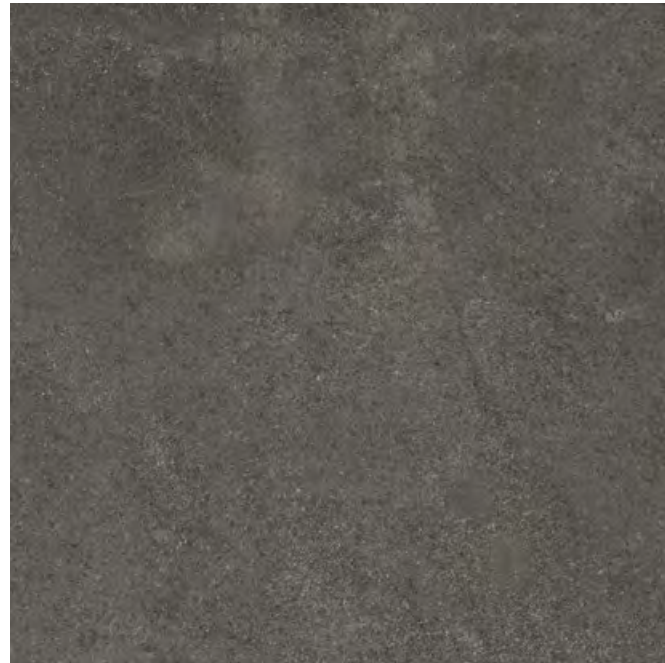

BE-SQUARE

COLORI E FORMATI

Colours and Sizes | Couleurs et Formats | Farben und Formate | Colores y Tamaños | Цвета и Форматы

6,5 mm.

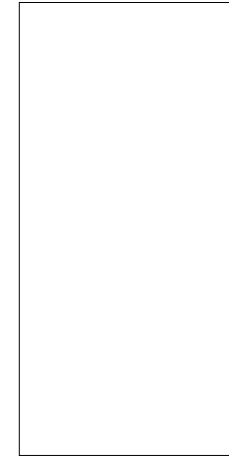

Naturale Rett.

120x240 - 47^{1/4}"x94^{1/2}"

- EDPK Ivory ● 88
- EDPL Sand ● 88
- EDPM Concrete ● 88
- EDPN Black ● 88

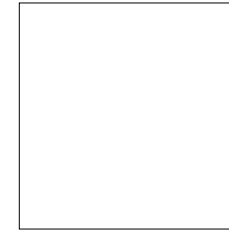

Naturale Rett.

120x120 - 47^{1/4}"x47^{1/4}"

- EDPF Ivory ● 86
- EDPG Sand ● 86
- EDPH Concrete ● 86
- EDPJ Black ● 86

Si consiglia la posa con fuga 2 mm. - Laying with a 2 mm-joint is recommended. - Pose recommandée avec joints de 2 mm.
Es wird eine Fugenbreite von 2 mm empfohlen. - Se recomienda la colocación con juntas de 2 mm. - Рекомендуется укладка с швом 2 мм.

BE-SQUARE

COLORI E FORMATI

Colours and Sizes | Couleurs et Formats | Farben und Formate | Colores y Tamaños | Цвета и Форматы

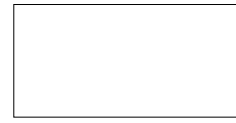

Naturale Rett.

60x120 - 23^{5/8}"x47^{1/4}"

- ECXU Ivory U₄P₃E₃C₂ ● 771
- ECXV Sand U₄P₃E₃C₂ ● 771
- ECXW Concrete U₄P₃E₃C₂ ● 771
- ECXX Black U₄P₃E₃C₂ ● 771



Naturale Rett.

80x80 - 31^{1/2}"x31^{1/2}"

- ECXG Ivory U₄P₃E₃C₂ ● 78
- ECXH Sand U₄P₃E₃C₂ ● 78
- ECXJ Concrete U₄P₃E₃C₂ ● 78
- ECXK Black U₄P₃E₃C₂ ● 78



Naturale Rett.

40x80 - 15^{3/4}"x31^{1/2}"

- ECX3 Ivory U₄P₄E₃C₂ ● 74
- ECX4 Sand U₄P₄E₃C₂ ● 74
- ECX5 Concrete U₄P₄E₃C₂ ● 74
- ECX6 Black U₄P₄E₃C₂ ● 74



Naturale Rett.

60x60 - 23^{5/8}"x23^{5/8}"

- ECX7 Ivory U₄P₄E₃C₂ ● 662
- ECX8 Sand U₄P₄E₃C₂ ● 662
- ECX9 Concrete U₄P₄E₃C₂ ● 662
- ECXA Black U₄P₄E₃C₂ ● 662



Naturale Rett.

30x60 - 11^{13/16}"x23^{5/8}"

- ECXC Ivory U₄P₄E₃C₂ ● 61
- ECXD Sand U₄P₄E₃C₂ ● 61
- ECXE Concrete U₄P₄E₃C₂ ● 61
- ECXF Black U₄P₄E₃C₂ ● 61



Naturale

20x20 - 7^{7/8}"x7^{7/8}"

- ED0A Ivory ● 60
- ED0C Sand ● 60
- ED0D Concrete ● 60
- ED0E Black ● 60

Lappato Rett.

80x80 - 31^{1/2}"x31^{1/2}"

- EDCM Ivory ● 81
- EDCN Sand ● 81
- EDCP Concrete ● 81
- EDCQ Black ● 81

Lappato Rett.

60x60 - 23^{5/8}"x23^{5/8}"

- EEN7 Ivory ● 771
- EEN8 Sand ● 771
- EEM3 Concrete ● 771
- EEN9 Black ● 771

20MM

Naturale Rett.

80x80 - 31^{1/2}"x31^{1/2}"

- ECR7 Concrete U₃₈P₃E₃C₂F₊ ● 87

Naturale Rett.

60x60 - 23^{5/8}"x23^{5/8}"

- ECYS Ivory ● 83
- ECYT Sand ● 83
- ECYU Concrete ● 83
- ECYV Black ● 83

BE-SQUARE

DECORI

Decors | Decors | Dekore | Decorados | Декоры

OPTICAL



30x30 - 11^{13/16}"x11^{13/16}"

EDRP Ivory/Sand Nat. Rett.

Pcs. Box 4

● 41

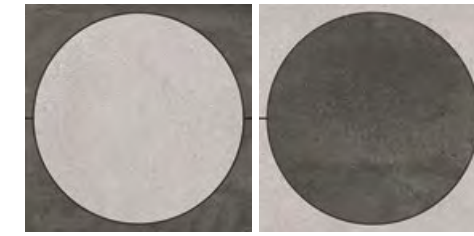

30x30 - 11^{13/16}"x11^{13/16}"

EDRQ Concrete/Black Nat. Rett.

Pcs. Box 4

● 41

MOSAICO 3X3*

Tessera - Chip 2,8x2,8 - 1^{1/8}"x1^{1/8}"



30x30 - 11^{13/16}"x11^{13/16}"

EDPT Ivory Nat.

● 96



30x30 - 11^{13/16}"x11^{13/16}"

EDPU Sand Nat.

● 96

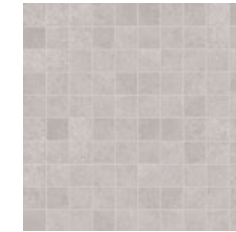

30x30 - 11^{13/16}"x11^{13/16}"

EDPV Concrete Nat.

● 96

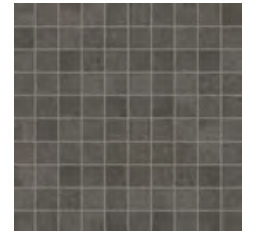

30x30 - 11^{13/16}"x11^{13/16}"

EDPW Black Nat.

● 96

LISTELLI SFALSATI*

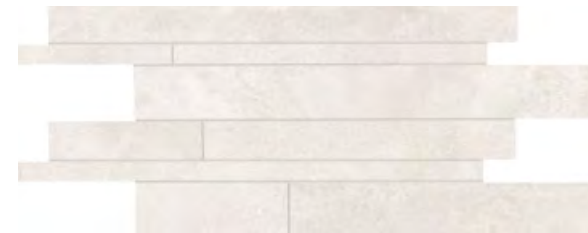

30x60 - 11^{13/16}"x23^{5/8}"

ED8K Ivory Nat.

● 87

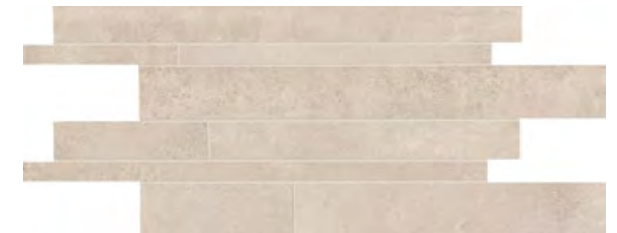

30x60 - 11^{13/16}"x23^{5/8}"

ED8L Sand Nat.

● 87

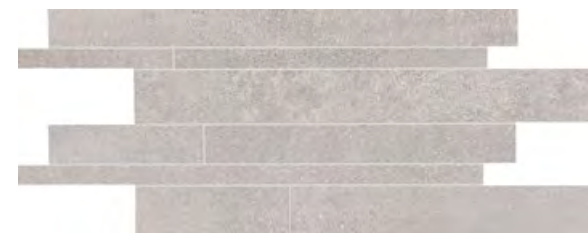

30x60 - 11^{13/16}"x23^{5/8}"

ED8M Concrete Nat.

● 87

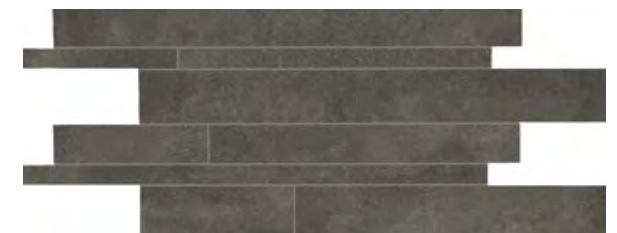

30x60 - 11^{13/16}"x23^{5/8}"

ED8N Black Nat.

● 87

Si consiglia la posa con fuga 2 mm. - Laying with a 2 mm-joint is recommended. - Pose recommandée avec joints de 2 mm.
Es wird eine Fugenbreite von 2 mm empfohlen. - Se recomienda la colocación con juntas de 2 mm. - Рекомендуется укладка с швом 2 мм.

* Su rete in fibra - On fibre mesh backing - Sur filet en fibre de verre - Auf Glasfasernetz - Sobre malla de fibra - На волоконной сетке

BE-SQUARE

DECORI

Decors | Decors | Dekore | Decorados | Декоры

BEDECOR MAJOLICA MIX



20x20 - 7⁷/₈"x7⁷/₈"

ED07 Rett.

● 85

BEDECOR MAJOLICA SINGLE



20x20 - 7⁷/₈"x7⁷/₈"

ED09 Rett.

● 85

20DECOR



20x20 - 7⁷/₈"x7⁷/₈"

ED62 Nat.

● 60

BEDECOR CONCRETE MIX



20x20 - 7⁷/₈"x7⁷/₈"

ED06 Nat. Rett.

● 85

BEDECOR CONCRETE SINGLE



20x20 - 7⁷/₈"x7⁷/₈"



ED08 Nat. Rett.

● 85

BE-SQUARE



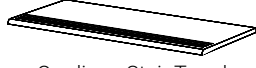
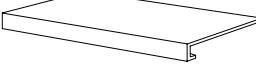





PEZZI SPECIALI

Trims | Pieces Speciales | Formteile | Piezas Especiales | Специальные Изделия

	Dimensione Size	Ivory	Sand	Concrete	Black	Fascia di prezzo Price band				
 Battiscopa - Skirting	Nat. Rett. 7x60 - 2 ³ / ₄ "x23 ⁵ / ₈ " Pcs. Box 14 - LM x Box 8,40	ECZV	ECZW	ECZX	ECZY	● 11				
	Nat. Rett. 4,6x80 - 1 ¹³ / ₁₆ "x31 ¹ / ₂ " Pcs. Box 12 - LM x Box 9,60	ECYJ	ECYK	ECYL	ECYM	● 16				
 Gradino - Stair Tread	Nat. Rett. 33x120 - 12 ¹⁵ / ₁₆ "x47 ¹ / ₄ " Pcs. Box 2 - LM x Box 2,40	ED8Q	ED8R	ED8S	ED8T	● 90				
 Gradone - Step	Nat. Rett. 33x120x3,2x3,2 12 ¹⁵ / ₁₆ "x47 ¹ / ₄ "x1 ¹ / ₄ "x1 ¹ / ₄ " Pcs. Box 2 - LM x Box 2,40	ECYN	ECYP	ECYQ	ECYR	● 95				
 Angolare Dx Sx Corner Tile Dx Sx	Nat. Rett. 33x120x3,2x3,2 12 ¹⁵ / ₁₆ "x47 ¹ / ₄ "x1 ¹ / ₄ "x1 ¹ / ₄ " Pcs. Box 1 - LM x Box 1,20	DX ECY9	SX ECYA	DX ECYC	SX ECYD	DX ECYE	SX ECYF	DX ECYG	SX ECYH	● 100

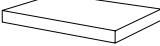
20MM PEZZI SPECIALI

Trims | Pieces Speciales | Formteile | Piezas Especiales | Специальные Изделия

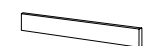

	Dimensione Size	 Ivory	 Sand	 Concrete	 Black	Fascia di prezzo Price band				
	Nat. Rett. 33x60x5 12 ^{15/16} "x23 ^{5/8} "x1 ^{15/16} " Pcs. Box 2 - LM x Box 1,20	ECZ0	ECZ3	ECZ6	ECZ9	● 83				
	Nat. Rett. 33x80x5 12 ^{15/16} "x31 ^{1/2} "x1 ^{15/16} " Pcs. Box 2 - LM x Box 1,60	-	-	EENA	-	● 88				
	Nat. Rett. 33x60x5 12 ^{15/16} "x23 ^{5/8} "x1 ^{15/16} " Pcs. Box 2 - LM x Box 1,20	DX ECZ1	SX ECZ2	DX ECZ4	SX ECZ5	DX ECZ7	SX ECZ8	DX ECZA	SX ECZC	● 93
	Nat. Rett. 33x80x5 12 ^{15/16} "x31 ^{1/2} "x1 ^{15/16} " Pcs. Box 2 - LM x Box 1,60	-	-	-	-	DX EENC	SX EEND	-	-	● 97
	Nat. Rett. 33x60x2,5 12 ^{15/16} "x23 ^{5/8} "x1 ^{15/16} " Pcs. Box 2 - LM x Box 1,20	ECZD	ECZG	ECZK	ECZN					● 83
	Nat. Rett. 33x80x2,5 12 ^{15/16} "x31 ^{1/2} "x1 ^{15/16} " Pcs. Box 2 - LM x Box 1,60	-	-	EENG		-				
	Nat. Rett. 33x60x2,5 12 ^{15/16} "x23 ^{5/8} "x1 ^{15/16} " Pcs. Box 2 - LM x Box 1,20	DX ECZE	SX ECZF	DX ECZH	SX ECZJ	DX ECZL	SX ECZM	DX ECZP	SX ECZQ	● 93
	Nat. Rett. 33x80x2,5 12 ^{15/16} "x31 ^{1/2} "x1 ^{15/16} " Pcs. Box 2 - LM x Box 1,60	-	-	-	-	DX EENH	SX EENJ	-	-	● 97
	Nat. Rett. 33x60 - 12 ^{15/16} "x23 ^{5/8} " Pcs. Box 2 - LM x Box 1,20	ECZR	ECZS	ECZT	ECZU					● 77
	Nat. Rett. 33x80 - 12 ^{15/16} "x31 ^{1/2} " Pcs. Box 2 - LM x Box 1,60	-	-	EENE	-					● 88
	Nat. Rett. 16,5x60 - 6 ^{1/2} "x23 ^{5/8} " Pcs. Box 2 - LM x Box 1,20	ECYW	ECYX	ECYY	ECYZ					● 40
	Nat. Rett. 16,5x80 - 6 ^{1/2} "x31 ^{1/2} " Pcs. Box 4 - LM x Box 3,20	-	-	EENF	-					● 53

IMBALLI E PESI

Packing and Weight | Emballages et Poids | Verpackung und Gewicht | Embalajes y Pesos | Упаковка и Вес

Formato Size Format Format Tamaño Формат cm	Spessore Thickness Epaisseur Stärke Espesor Толщина mm	Pz. x Mq. Pieces x Sqm Pcs / M ² Stk. x Qm Pzs x Mc. Шт x Кв.М.	Pz. x Scat. Pieces x Box Pcs / Bte Stk. x Krt. Pzs x Caja Шт x Кор.	Mq. x Scat. Sqm x Box M ² / Bte Qm x Krt. Mc. x Caja Кв.М. x Кор.	Peso x Scat. Weight x Box Poids / Bte Gewicht x Krt. Peso x Caja Вес x Кор. Kg	Scat. x Pal. Boxes x Pal. Bte / Pal. Krt. x Pal. Cajas x Pal. Кор. x Подд.	Mq. x Pal. Sqm x Pal. M ² / Pal. Qm x Pal. Mc. x Pal. Кв.М. x Подд.	Peso x Pal. Weight x Pal. Poids / Pal. Gewicht x Pal. Peso x Pal. Вес x Подд. Kg
120x240 Naturale	6,5	0,35	1	2,880	45,90	vedi sotto - see below		
120x120 Naturale	6,5	0,69	1	1,440	22			
60x120 Naturale	10	1,39	2	1,440	34,13	36	51,84	1229
80x80 Naturale - Lappato	10	1,56	2	1,280	28,93	42	53,76	1215
80x80 Naturale 20MM	20	1,56	1	0,640	29,05	45	28,80	1307
40x80 Naturale	10	3,13	3	0,960	22,01	28	26,88	616
60x60 Naturale - Lappato	10	2,78	3	1,080	24,55	40	43,20	982
60x60 Naturale 20MM	20	2,78	2	0,720	31,87	32	23,04	1020
30x60 Naturale	10	5,56	6	1,080	24,17	40	43,20	967
20x20 Naturale - 20Decor	10	25,00	24	0,960	19,85	54	51,84	1072
30x60 Listelli sfalsati	10	5,56	4	0,720	16,5	30	21,60	495
30x30 Mosaico 3X3	10	11,11	5	0,450	10,42	60	27,00	625
20x20 BeDecor	10	25,00	17	0,680	13,48	72	48,96	971

Slabs 120x120 - 120x240

Articolo Item Reference Artikel Articulo Артикул	Dimensione (cm) Size (cm) Format (cm) Format (cm) Tamaño (cm) Формат (cm)	Nr. Lastre No. of Slabs Nbre Dalles Anz. Platten Nº de Placas Кол. Плит	Mq. x Imballo sqm per Pack m ² / Emballage qm pro Verpackung m ² por embalaje Кв.м. x упаковку	Peso Imballo (Kg) Weight of Packaging (kg) Poids Emballage (kg) Gewicht Verpackung (kg) Peso embalaje (kg) Вес упаковки (кг)	Peso Imballo+Lastre (Kg) Weight of Packaging + Slabs (kg) Weight of Packaging + Dalles (kg) Gewicht Verpackung+Platten (kg) Gewicht Verpackung + placas (kg) Вес упаковки + плит (кг)
 120x120	139x139x41h	24	35,56	62,5	613,3
 120x240	136x266x41h	20	57,60	99	1020,6
 120x240	75x250x160h	40	115,20	163	2006,2

FORMATI

Sizes | Formats | Formate | Tamaños | Форматы

9 mm.

6x25 - 2³/₈"x9¹³/₁₆" Naturale

SUPERFICI

Finishes | Finitions | Oberflächen
Superficies | Отделка поверхности

NATURALE

R10 DIN 51130

A DIN 51097

Wet \geq 0,50 ANSI A 137.1- 2012 DCOF (Section 9.6)

\geq 0,40 B.C.R.A.

P2 AS 4586: 2013

< 36 Moderate Slip potential BS 7976-2: 2002

- ENV 12633-2006

SHADE VARIATIONS



V2 MODERATE

DESTINAZIONI D'USO

Intended uses | Domaines d'application
Zweckbestimmung | Usos previstos | Назначение



Min. 7,5%



GESSO

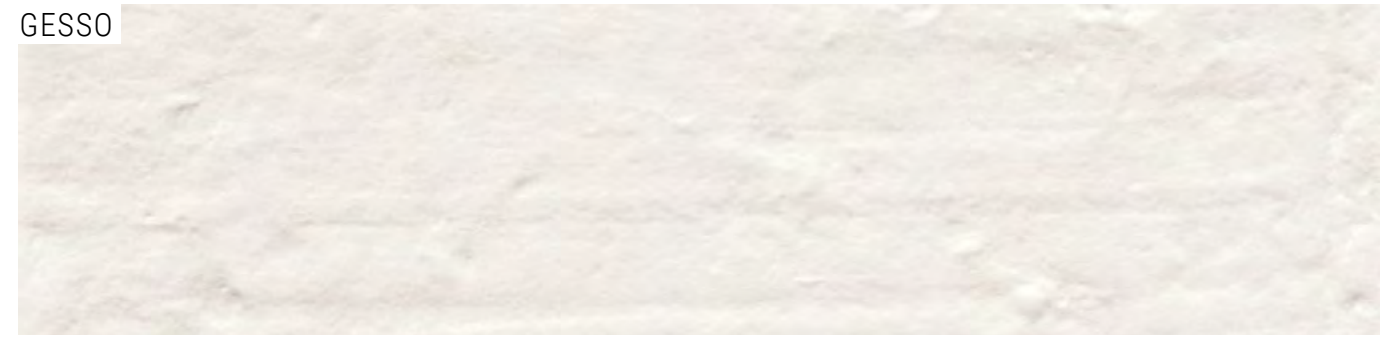

SETA

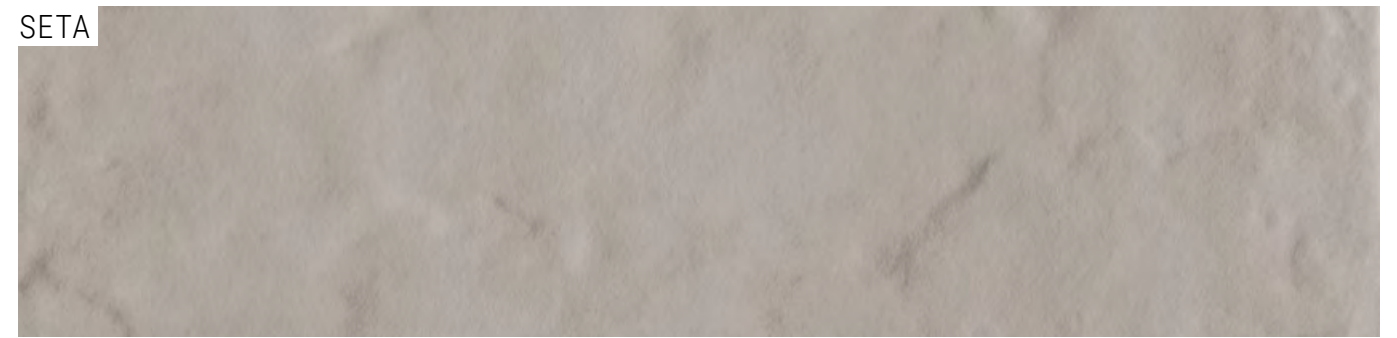

CARBONE

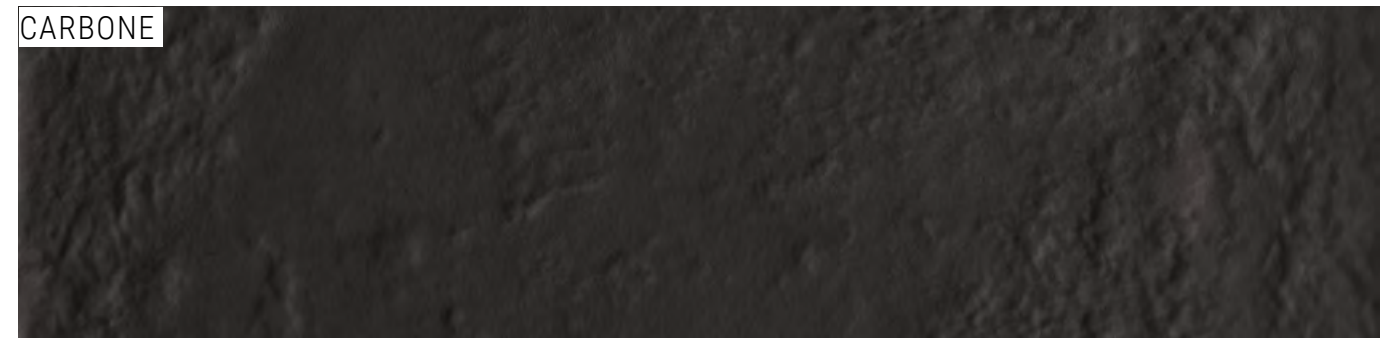

PAGLIA



TORTORA



MOKA



BRICK DESIGN

COLORI E FORMATI

Colours and Sizes | Couleurs et Formats | Farben und Formate | Colores y Tamaños | Цвета и Форматы

Gesso



Seta



Carbone

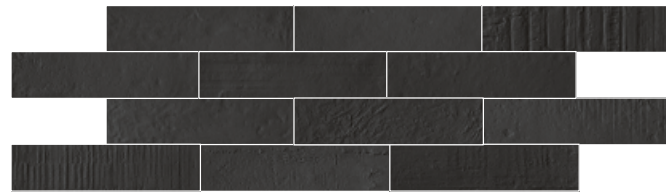

Paglia



Tortora

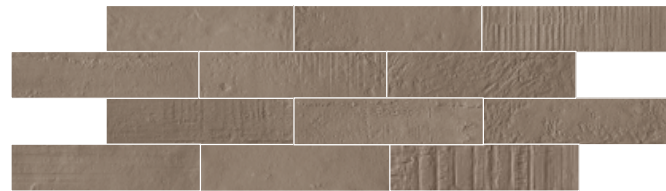

Moka

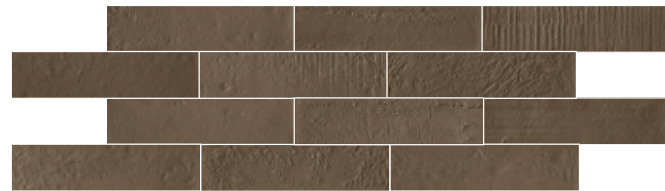

COLORI E FORMATI

Colours and Sizes | Couleurs et Formats | Farben und Formate | Colores y Tamaños | Цвета и Форматы



-  **Naturale**
6x25 - 2^{3/8} x 9^{13/16}
- E30W Gesso** ● 60
- E331 Seta** ● 60
- E332 Carbone** ● 60
- E32Y Paglia** ● 60
- E32Z Tortora** ● 60
- E330 Moka** ● 60

Posa pavimento Si consiglia la posa con fuga 3 mm. **Posa rivestimento** Si consiglia la posa con fuga 8 mm.
Laying on floor Laying with a 3 mm-joint is recommended. **Laying on wall** Laying with a 8 mm-joint is recommended.
Pose sur sol Pose recommandée avec joints de 3 mm. **Pose sur revêtement mural** Pose recommandée avec joints de 8 mm.
Als Bodenbelag Es wird eine Fugenbreite von 3 mm empfohlen. **Als Wandverkleidung** Es wird eine Fugenbreite von 8 mm empfohlen.
Pavimento Se recomienda la colocación con juntas de 3 mm. **Revestimiento** Se recomienda la colocación con juntas de 8 mm.
Настил полов Рекомендуется укладка с швом 3 мм. **Облицовка стен** Рекомендуется укладка с швом 8 мм.

PEZZI SPECIALI

Trims | Peces Speciales | Formteile | Piezas Especiales | Специальные Изделия

	Dimensione Size	 Gesso	 Seta	 Carbone	 Paglia	 Tortora	 Moka	Fascia di prezzo Price band
 Brick Angolare - Brick Corner	Nat. (AxBxC) 6x25x12,5 2 ^{3/8} x 9 ^{13/16} x 4 ^{15/16} Pcs. Box 12	E38X	E9G3	E9G4	E9G0	E9G1	E9G2	● 27
 Becco Civetta - Bullnose	Nat. 6x25 - 2 ^{3/8} x 9 ^{13/16} Pcs. Box 34	E396	E9GE	E395	E9GA	E9GC	E9GD	● 7

IMBALLI E PESI

Packing and Weight | Emballages et Poids | Verpackung und Gewicht | Embalajes y Pesos | Упаковка и Вес

Formato Size	Spessore Thickness	Pz. x Mq. Pieces x Sqm	Pz. x Scat. Pieces x Box	Mq. x Scat. Sqm x Box	Peso x Scat. Weight x Box	Scat. x Pal. Boxes x Pal.	Mq. x Pal. Sqm x Pal.	Peso x Pal. Weight x Pal.
Format	Epaisseur	Pcs / M ²	Pcs / Bte	M ² / Bte	Poids / Bte	Bte / Pal.	M ² / Pal.	Poids / Pal.
Format	Stärke	Stk. x Qm	Stk. x Krt.	Qm x Krt.	Gewicht x Krt.	Krt. x Pal.	Qm x Pal.	Gewicht x Pal.
Tamaño	Espesor	Pzs x Mc.	Pzs x Caja	Mc. x Caja	Peso x Caja	Cajas x Pal.	Mc. x Pal.	Peso x Pal.
Формат	Толщина	Шт x Кв.М.	Шт x Кор.	Кв.М. x Кор.	Вес x Кор.	Кор. x Подд.	Кв.М x Подд.	Вес x Подд.
cm	mm				Kg			Kg
6x25 Naturale	9	66,67	34	0,510	9,28	99	50,49	919

BRIXENSTONE

FORMATI

Sizes | Formats | Formate | Tamaños | Форматы

9,5 mm.

30x60 - 11^{13/16}"x23^{5/8}" Naturale

10 mm.

20x40 - 7^{7/8}"x15^{3/4}" Naturale

20x20 - 7^{7/8}"x 7^{7/8}" Naturale

SUPERFICI

Finishes | Finitions | Oberflächen
Superficies | Отделка поверхности

NATURALE

R10 DIN 51130

B (A+B) DIN 51097

Wet \geq 0,42 ANSI A 137.1- 2012 DCOF (Section 9.6)

\geq 0,40 B.C.R.A.

P2 AS 4586: 2013

> 36 Low Slip potential BS 7976-2: 2002

2 ENV 12633-2006

SHADE VARIATIONS



V3 HIGH

DESTINAZIONI D'USO

Intended uses | Domaines d'application
Zweckbestimmung | Usos previstos | Назначение



Min. 7,5%



IVORY



SAND



GREY

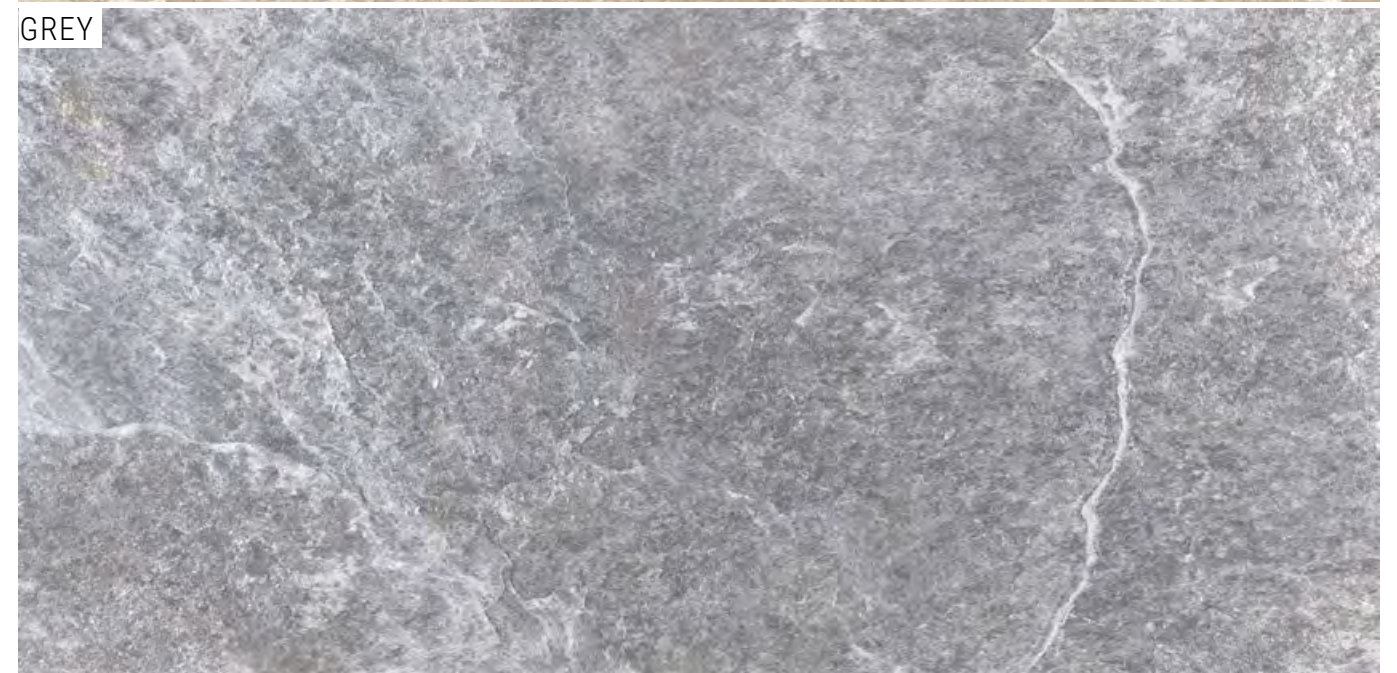

BRIXENSTONE

COLORI E FORMATI

Colours and Sizes | Couleurs et Formats | Farben und Formate | Colores y Tamaños | Цвета и Форматы

Ivory



Sand



Grey

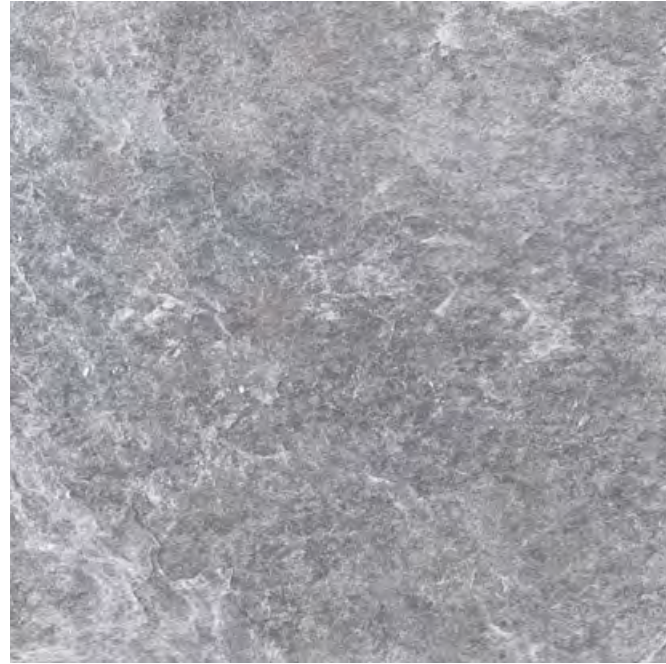

BRIXENSTONE

COLORI E FORMATI

Colours and Sizes | Couleurs et Formats | Farben und Formate | Colores y Tamaños | Цвета и Форматы

9,5 mm.

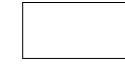

Naturale Rett.
30x60 - 11^{13/16}"x23^{5/8}"

EFGQ Ivory ● 55
EFG7 Sand ● 55
EFH3 Grey ● 55

10 mm.



Naturale
20x40 - 7^{7/8}"x15^{3/4}"

EFAT Ivory ● 49
EFAU Sand ● 49
EFAV Grey ● 49



Naturale
20x20 - 7^{7/8}"x7^{7/8}"

EFAM Ivory ● 49
EFAN Sand ● 49
EFAP Grey ● 49

Si consiglia la posa con fuga 2 mm. - Laying with a 2 mm-joint is recommended. - Pose recommandée avec joints de 2 mm.
Es wird eine Fugenbreite von 2 mm empfohlen. - Se recomienda la colocación con juntas de 2 mm. - Рекомендуется укладка с швом 2 мм.

BRIXENSTONE

DECORI

Decors | Decors | Dekore | Decorados | Декоры

9,5 mm. MOSAICO 5X5* Naturale: Tessera - Chip 4,8x4,8 - 17/8"x17/8"



30x30 - 11^{13/16}"x11^{13/16}"
EFRF Ivory Nat. ● 93

30x30 - 11^{13/16}"x11^{13/16}"
EFRG Sand Nat. ● 93

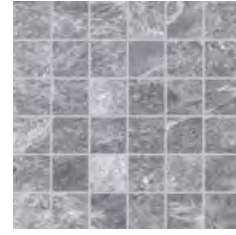

30x30 - 11^{13/16}"x11^{13/16}"
EFRH Grey Nat. ● 93

9,5 mm. LISTELLI SFALSATI*

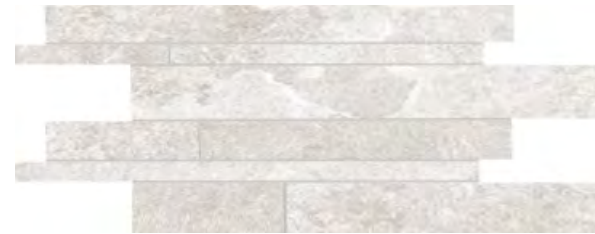

30x60 - 11^{13/16}"x23^{5/8}"
EFRJ Ivory Nat. ● 87



30x60 - 11^{13/16}"x23^{5/8}"
EFRK Sand Nat. ● 87

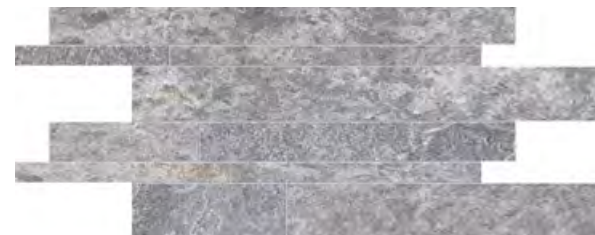

30x60 - 11^{13/16}"x23^{5/8}"
EFRL Grey Nat. ● 87

BRIXENSTONE

PEZZI SPECIALI

Trims | Pieces Speciales | Formteile | Piezas Especiales | Специальные Изделия

	Dimensione Size				Fascia di prezzo Price band
 Battiscopa - Skirting	Nat. Rett. 7x60 - 2 ^{3/4} "x23 ^{5/8} " Pcs. Box 14 - LM x Box 8,40	EFRM	EFRN	EFRP	● 11
 Gradino - Stair Tread	Nat. Rett. 30x60 - 11 ^{13/16} "x23 ^{5/8} " Pcs. Box 6 - LM x Box 3,60	EFRQ	EFRR	EFRS	● 46
 Gradone - Step	Nat. Rett. 30x60x3,2x3,2 11 ^{13/16} "x23 ^{5/8} "x1 ^{1/4} "x1 ^{1/4} " Pcs. Box 4 - LM x Box 2,40	EVRT	EFRU	EFRV	● 76
 Angolare - Corner Tile	Nat. Rett. 30x30x3,2x3,2 11 ^{13/16} "x11 ^{13/16} "x1 ^{1/4} "x1 ^{1/4} " Pcs. Box 2 - LM x Box 0,60	EFRW	EFRX	EFRY	● 781

IMBALLI E PESI

Packing and Weight | Emballages et Poids | Verpackung und Gewicht | Embalajes y Pesos | Упаковка и Вес

Formato Size Format Format Tamaño Формат cm	Spessore Thickness Epaisseur Stärke Espesor Толщина mm	Pz. x Mq. Pieces x Sqm Pcs / M ² Stk. x Qm Pzs x Mc. Шт x Кв.М.	Pz. x Scat. Pieces x Box Pcs / Bte Stk. x Krt. Pzs x Caja Шт x Кор.	Mq. x Scat. Sqm x Box M ² / Bte Qm x Krt. Mc. x Caja Кв.М. x Кор.	Peso x Scat. Weight x Box Poids / Bte Gewicht x Krt. Peso x Caja Вес x Кор. Kg	Scat. x Pal. Boxes x Pal. Bte / Pal. Krt. x Pal. Cajas x Pal. Кор. x Подд.	Mq. x Pal. Sqm x Pal. M ² / Pal. Qm x Pal. Mc. x Pal. Кв.М x Подд.	Peso x Pal. Weight x Pal. Poids / Pal. Gewicht x Pal. Peso x Pal. Вес x Подд. Kg
30x60 Naturale	9,5	5,56	6	1,080	23,7	48	51,84	1138
20x40 Naturale	10	12,50	12	0,960	21,89	54	51,84	1182
20x20 Naturale	10	25,00	24	0,960	19,04	54	51,84	1028
30x30 Mosaico 5X5	9,5	11,11	5	0,450	10,40	60	27,00	624
30x60 Listelli Sfalsati	9,5	5,56	4	0,720	16,5	30	21,60	495

* Su rete in fibra - On fibre mesh backing - Sur filet en fibre de verre - Auf Glasfasernetz - Sobre malla de fibra - На волоконной сетке

CHATEAU

FORMATI

Sizes | Formats | Formate | Tamaños | Форматы

-  **10 mm.** 120x120 - 47^{1/4}"x47^{1/4}" Nat. - Lapp.
60x120 - 23^{5/8}"x47^{1/4}" Nat. - Lapp.
80x80 - 31^{1/2}"x31^{1/2}" Nat. - Lapp.
40x80 - 15^{3/4}"x31^{1/2}" Nat. - Lapp.
60x60 - 23^{5/8}"x23^{5/8}"
Nat. - Lapp. - Antislip
30x60 - 11^{13/16}"x23^{5/8}" Nat. - Lapp.

20MM

80x80 - 31^{1/2}"x31^{1/2}" Naturale

SUPERFICI

Finishes | Finitions | Oberflächen
Superficies | Отделка поверхности

■ NATURALE

R10 DIN 51130

B (A+B) DIN 51097

Wet \geq 0,50 ANSI A 137.1- 2012 DCOF (Section 9.6)

\geq 0,40 B.C.R.A.

P3 AS 4586: 2013

> 36 Low Slip potential BS 7976-2: 2002

2 ENV 12633-2006

■ LAPPATO

R9 DIN 51130

- DIN 51097

Wet \geq 0,42 ANSI A 137.1- 2012 DCOF (Section 9.6)

\geq 0,40 B.C.R.A.

- AS 4586: 2013

- BS 7976-2: 2002

- ENV 12633-2006

■ ANTISLIP | 20MM

R11 DIN 51130

C (A+B+C) DIN 51097

Wet \geq 0,65 ANSI A 137.1- 2012 DCOF (Section 9.6)

\geq 0,40 B.C.R.A.

P4 AS 4586: 2013

> 36 Low Slip potential BS 7976-2: 2002

3 ENV 12633-2006

SHADE VARIATIONS



V3 HIGH

DESTINAZIONI D'USO

Intended uses | Domaines d'application
Zweckbestimmung | Usos previstos | Назначение

NATURALE - 20MM



LAPPATO



Min. 7,5%



BLANC



BEIGE



GRIS



NOIR

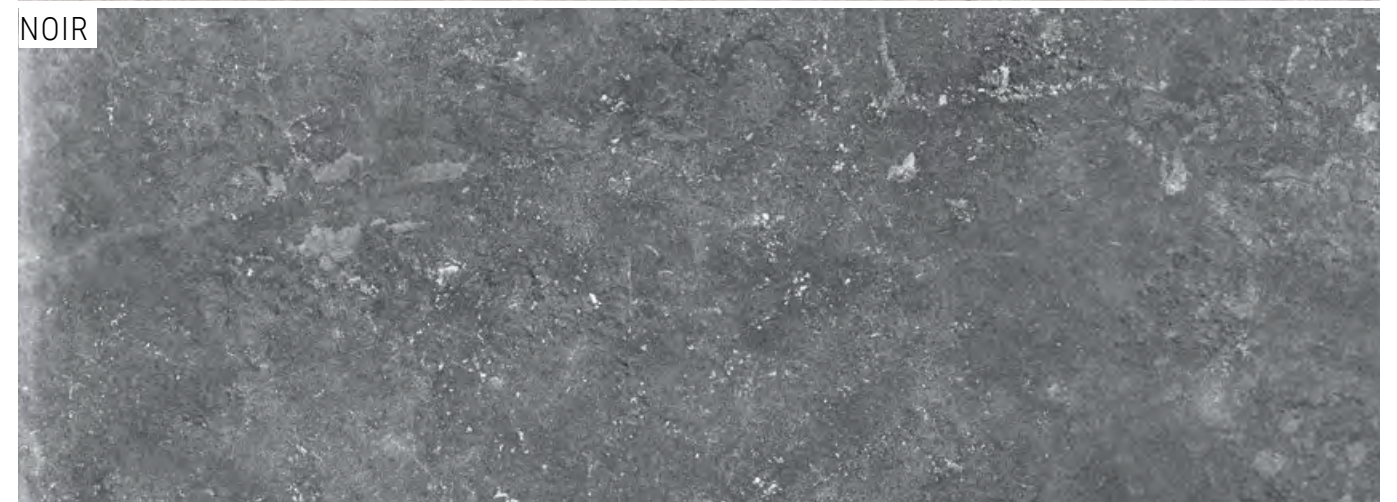

COLORI E FORMATI

Colours and Sizes | Couleurs et Formats | Farben und Formate | Colores y Tamaños | Цвета и Форматы

Blanc

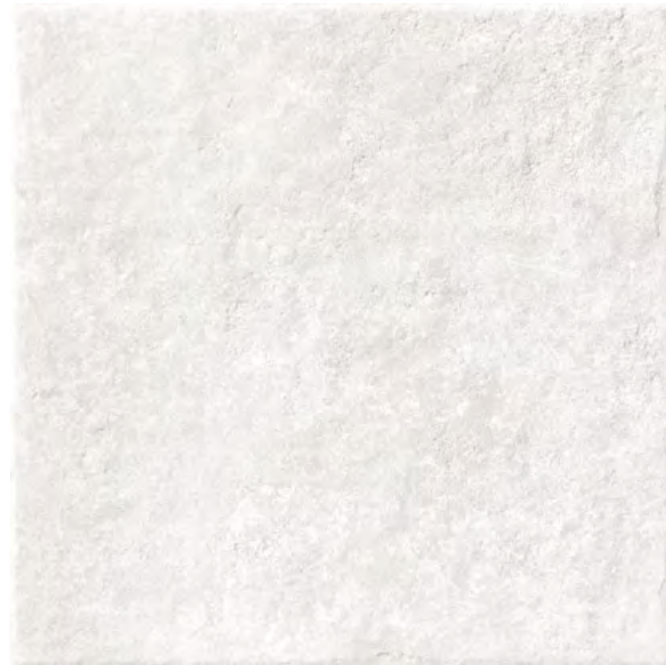

Beige



Gris



Noir

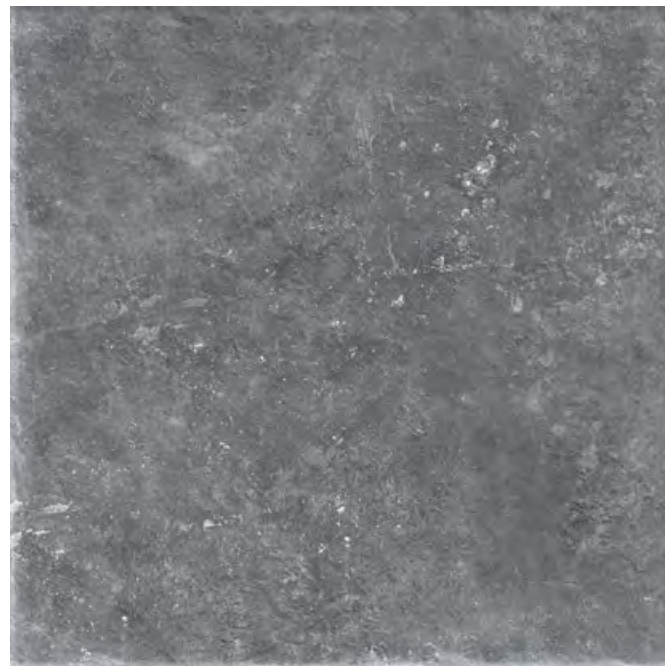

COLORI E FORMATI

Colours and Sizes | Couleurs et Formats | Farben und Formate | Colores y Tamaños | Цвета и Форматы

10 mm.

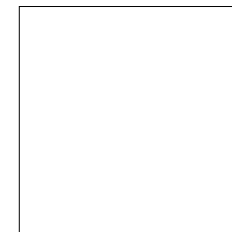

Naturale Rett.

120x120 - 47^{1/4}"x47^{1/4}"

- EFLA Blanc ● 81
- EFLC Beige ● 81
- EFLD Gris ● 81
- EFLJ Noir ● 81

Lappato Rett.

120x120 - 47^{1/4}"x47^{1/4}"

- EFLF Blanc ● 85
- EFLG Beige ● 85
- EFLH Gris ● 85
- EFLJ Noir ● 85



Naturale Rett.

60x120 - 23^{5/8}"x47^{1/4}"

- EFLP Blanc U₄P₃E₃C₂ ● 771
- EFLQ Beige U₄P₃E₃C₂ ● 771
- EFLR Gris U₄P₃E₃C₂ ● 771
- EFLS Noir U₄P₃E₃C₂ ● 771

Lappato Rett.

60x120 - 23^{5/8}"x47^{1/4}"

- EFL9 Blanc ● 80
- EFMA Beige ● 80
- EFMC Gris ● 80
- EFMD Noir ● 80



Naturale Rett.

80x80 - 31^{1/2}"x31^{1/2}"

- EFL1 Blanc U₄P₃E₃C₂ ● 78
- EFL2 Beige U₄P₃E₃C₂ ● 78
- EFL3 Gris U₄P₃E₃C₂ ● 78
- EFL4 Noir U₄P₃E₃C₂ ● 78

Lappato Rett.

80x80 - 31^{1/2}"x31^{1/2}"

- EFMN Blanc ● 81
- EFMP Beige ● 81
- EFMQ Gris ● 81
- EFMR Noir ● 81



Naturale Rett.

40x80 - 15^{3/4}"x31^{1/2}"

- EFL5 Blanc U₄P₄E₃C₂ ● 74
- EFL6 Beige U₄P₄E₃C₂ ● 74
- EFL7 Gris U₄P₄E₃C₂ ● 74
- EFL8 Noir U₄P₄E₃C₂ ● 74

Lappato Rett.

40x80 - 15^{3/4}"x31^{1/2}"

- EFMS Blanc ● 79
- EFMT Beige ● 79
- EFMU Gris ● 79
- EFMV Noir ● 79



Naturale Rett.

60x60 - 23^{5/8}"x23^{5/8}"

- EFLT Blanc U₄P₄₊E₃C₂ ● 662
- EFLU Beige U₄P₄₊E₃C₂ ● 662
- EFLV Gris U₄P₄₊E₃C₂ ● 662
- EFLW Noir U₄P₄₊E₃C₂ ● 662

Lappato Rett.

60x60 - 23^{5/8}"x23^{5/8}"

- EFME Blanc ● 771
- EFMF Beige ● 771
- EFMG Gris ● 771
- EFMH Noir ● 771

Antislip Rett.

60x60 - 23^{5/8}"x23^{5/8}"

- EFMW Blanc ● 662
- EFMX Beige ● 662
- EFMY Gris ● 662
- EFMZ Noir ● 662



Naturale Rett.

30x60 - 11^{13/16}"x23^{5/8}"

- EFLX Blanc U₄P₄E₃C₂ ● 61
- EFLY Beige U₄P₄E₃C₂ ● 61
- EFLZ Gris U₄P₄E₃C₂ ● 61
- EFL0 Noir U₄P₄E₃C₂ ● 61

Lappato Rett.

30x60 - 11^{13/16}"x23^{5/8}"

- EFMJ Blanc ● 73
- EFMK Beige ● 73
- EFML Gris ● 73
- EFMM Noir ● 73

20MM

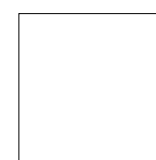

Naturale Rett.

80x80 - 31^{1/2}"x31^{1/2}"

- EFM0 Blanc U₄P₃E₃C₂F₊ ● 87
- EFM1 Beige U₄P₃E₃C₂F₊ ● 87
- EFM2 Gris U₄P₃E₃C₂F₊ ● 87
- EFM3 Noir U₄P₃E₃C₂F₊ ● 87

Si consiglia la posa con fuga 2 mm. - Laying with a 2 mm-joint is recommended. - Pose recommandée avec joints de 2 mm.
Es wird eine Fugenbreite von 2 mm empfohlen. - Se recomienda la colocación con juntas de 2 mm. - Рекомендуются укладка с швом 2 мм.

DECORI

Decors | Decors | Dekore | Decorados | Декоры

MOSAICO 5X5*

Tessera - Chip 4,8x4,8 - 1^{7/8}"x1^{7/8}"



30x30 - 11^{13/16}"x11^{13/16}"
EFSY Blanc Nat. ● 93



30x30 - 11^{13/16}"x11^{13/16}"
EFSZ Beige Nat. ● 93



30x30 - 11^{13/16}"x11^{13/16}"
EFT0 Gris Nat. ● 93

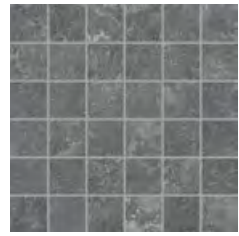

30x30 - 11^{13/16}"x11^{13/16}"
EFT1 Noir Nat. ● 93

MOSAICO MUR*



30x30 - 11^{13/16}"x11^{13/16}"
EFT2 Blanc Nat. ● 97



30x30 - 11^{13/16}"x11^{13/16}"
EFT3 Beige Nat. ● 97



30x30 - 11^{13/16}"x11^{13/16}"
EFT4 Gris Nat. ● 97



30x30 - 11^{13/16}"x11^{13/16}"
EFT5 Noir Nat. ● 97

MOSAICO PETITE MUR*



30x30 - 11^{13/16}"x11^{13/16}"
EFTU Blanc Nat. ● 1011



30x30 - 11^{13/16}"x11^{13/16}"
EFTV Beige Nat. ● 1011



30x30 - 11^{13/16}"x11^{13/16}"
EFTW Gris Nat. ● 1011



30x30 - 11^{13/16}"x11^{13/16}"
EFTX Noir Nat. ● 1011

* Su rete in fibra - On fibre mesh backing - Sur filet en fibre de verre - Auf Glasfasernetz - Sobre malla de fibra - На волоконной сетке

IMBALLI E PESI

Packing and Weight | Emballages et Poids | Verpackung und Gewicht | Embalajes y Pesos | Упаковка и Вес

Formato Size Format Format Тamaño Формат cm	Spessore Thickness Epaisseur Stärke Espesor Толщина mm	Pz. x Mq. Pieces x Sqm Pcs / M ² Stk. x Qm Pzs x Mc. Шт x Кв.М.	Pz. x Scat. Pieces x Box Pcs / Bte Stk. x Krt. Pzs x Caja Шт x Кор.	Mq. x Scat. Sqm x Box M ² / Bte Qm x Krt. Mc. x Caja Кв.М. x Кор.	Peso x Scat. Weight x Box Poids / Bte Gewicht x Krt. Peso x Caja Вес x Кор. Kg	Scat. x Pal. Boxes x Pal. Bte / Pal. Krt. x Pal. Cajas x Pal. Кор. x Подд.	Mq. x Pal. Sqm x Pal. M ² / Pal. Qm x Pal. Mc. x Pal. Кв.М x Подд.	Peso x Pal. Weight x Pal. Poids / Pal. Gewicht x Pal. Peso x Pal. Вес x Подд. Kg
120x120 Naturale - Lappato	10	0,69	1	1,440	31,87	36	51,84	1147
60x120 Naturale - Lappato	10	1,39	2	1,440	33,57	36	51,84	1209
80x80 Naturale - Lappato	10	1,56	2	1,280	30,55	42	53,76	1283
80x80 Naturale 20MM	20	1,56	1	0,640	29,58	45	28,80	1331
40x80 Naturale - Lappato	10	3,13	3	0,960	22,38	28	26,88	627
60x60 Nat. - Lappato - Antislip	10	2,78	3	1,080	24,06	40	43,20	962
30x60 Naturale - Lappato	10	5,56	6	1,080	25,58	40	43,20	1023
30x30 Mosaico 5X5	10	11,11	5	0,450	10,20	60	27,00	612
30x30 Mosaico Mur - Petit Mur	10	11,11	5	0,450	10,2	60	27,00	612

PEZZI SPECIALI

Trims | Pieces Speciales | Formteile | Piezas Especiales | Специальные Изделия

	Dimensione Size	Blanc	Beige	Gris	Noir	Fascia di prezzo Price band				
 Battiscopa - Skirting	Nat. Rett. 7x60 - 2 ^{3/4} "x23 ^{5/8} " Pcs. Box 14 - LM x Box 8,40	EFTY	EFTZ	EFU0	EFU1	● 11				
	Nat. Rett. 4,6x80 - 1 ^{13/16} "x31 ^{1/2} " Pcs. Box 12 - LM x Box 9,60	EFU2	EFU3	EFU4	EFU5	● 16				
 Gradino - Stair Tread	Nat. Rett. 33x120 - 12 ^{15/16} "x47 ^{1/4} " Pcs. Box 2 - LM x Box 2,40	EFU6	EFU7	EFU8	EFU9	● 90				
	Nat. Rett. 33x120x3,2x3,2 12 ^{15/16} "x47 ^{1/4} "x1 ^{1/4} "x1 ^{1/4} " Pcs. Box 2 - LM x Box 2,40	EFUA	EFUC	EFUD	EFUE	● 95				
 Gradone - Step	Lapp. Rett. 33x120x3,2x3,2 12 ^{15/16} "x47 ^{1/4} "x1 ^{1/4} "x1 ^{1/4} " Pcs. Box 2 - LM x Box 2,40	EFUP	EFUQ	EFUR	EFUS	● 99				
	Nat. Rett. 33x120x3,2x3,2 12 ^{15/16} "x47 ^{1/4} "x1 ^{1/4} "x1 ^{1/4} " Pcs. Box 1 - LM x Box 1,20	DX EFUF	SX EFUK	DX EFUG	SX EFUL	DX EFUH	SX EFUM	DX EFUJ	SX EFUN	● 100
 Angolare Dx Sx Corner Tile Dx Sx	Lapp. Rett. 33x120x3,2x3,2 12 ^{15/16} "x47 ^{1/4} "x1 ^{1/4} "x1 ^{1/4} " Pcs. Box 2 - LM x Box 2,40	DX EFUT	SX EFUX	DX EFUU	SX EFUY	DX EFUV	SX EFUZ	DX EFUW	SX EFV0	● 101

20MM PEZZI SPECIALI

Trims | Pieces Speciales | Formteile | Piezas Especiales | Специальные Изделия

	Dimensione Size	Blanc	Beige	Gris	Noir	Fascia di prezzo Price band			
 Gradone - Step	Nat. Rett. 33x80x5 11 ^{21/16} "x31 ^{1/2} "x1 ^{15/16} " Pcs. Box 2 - LM x Box 1,60	EFV9	EFVA	EFVC	EFVD	● 88			
	Nat. Rett. 33x80x5 12 ^{15/16} "x31 ^{1/2} "x1 ^{15/16} " Pcs. Box 2 - LM x Box 1,60	DX EFVE	SX EFVJ	DX EFVF	SX EFVK	DX EFVG	SX EFVL	DX EFVH	SX EFVM
 Terminale - Endingpiece	Nat. Rett. 33x80x2,5 12 ^{15/16} "x31 ^{1/2} "x1 ^{15/16} " Pcs. Box 2 - LM x Box 1,60	EFVN	EFVP	EFVQ	EFVR	● 90			
	Nat. Rett. 33x80x2,5 12 ^{15/16} "x31 ^{1/2} "x1 ^{15/16} " Pcs. Box 2 - LM x Box 1,60	DX EFVS	SX EFVW	DX EFVT	SX EFVX	DX EFVU	SX EFVY	DX EFVV	SX EFVZ
 Gradino - Stair Tread	Nat. Rett. 33x80 - 12 ^{15/16} "x31 ^{1/2} " Pcs. Box 2 - LM x Box 1,60	EFV1	EFV2	EFV3	EFV4	● 88			
	Nat. Rett. 16,5x80 - 6 ^{1/2} "x31 ^{1/2} " Pcs. Box 4 - LM x Box 3,20	EFV5	EFV6	EFV7	EFV8	● 53			

DIMORE

FORMATI

Sizes | Formats | Formate | Tamaños | Форматы

9 mm.

20x120 - 77^{7/8} x 47^{1/4} Naturale

SUPERFICI

Finishes | Finitions | Oberflächen
Superficies | Отделка поверхности

■ NATURALE

R9 DIN 51130

A DIN 51097

Wet $\geq 0,42$ ANSI A 137.1- 2012 DCOF (Section 9.6)

$\geq 0,40$ B.C.R.A.

- AS 4586: 2013

- BS 7976-2: 2002

- ENV 12633-2006

SHADE VARIATIONS



V3 HIGH

DESTINAZIONI D'USO

Intended uses | Domaines d'application
Zweckbestimmung | Usos previstos | Назначение



Min. 7,5%



SBIANCATO

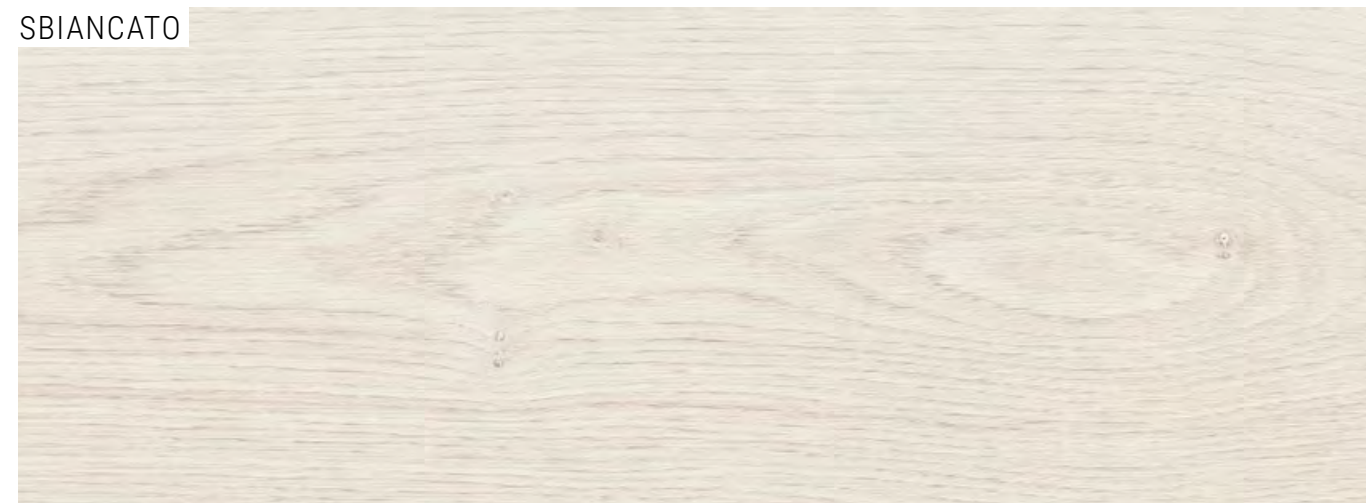

NATURALE



DORATO



TABACCO



COLORI E FORMATI

Colours and Sizes | Couleurs et Formats | Farben und Formate | Colores y Tamaños | Цвета и Форматы

Sbiancato



Naturale



Dorato



Tabacco



COLORI E FORMATI

Colours and Sizes | Couleurs et Formats | Farben und Formate | Colores y Tamaños | Цвета и Форматы

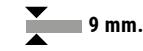

- Naturale**
20x120 - 7^{7/8}"x47^{1/4}"
- EGN6** Sbiancato ● 57
- EGN7** Naturale ● 57
- EGN8** Dorato ● 57
- EGN9** Tabacco ● 57

Si consiglia la posa con fuga 2 mm.
Laying with a 2 mm-joint is recommended.
Pose recommandée avec joints de 2 mm.
Es wird eine Fugenbreite von 2 mm empfohlen.
Se recomienda la colocación con juntas de 2 mm.
Рекомендуется укладка с швом 2 мм.

DECORI

Decors | Decors | Dekore | Decorados | Декоры



20x20 - 7^{7/8}"x7^{7/8}"
EGNC Cubo ● 60



20x20 - 7^{7/8}"x7^{7/8}"
EGNE Diamante ● 60



20x20 - 7^{7/8}"x7^{7/8}"
EGNQ Riquadro ● 60



20x20 - 7^{7/8}"x7^{7/8}"
EGNJ Foglie ● 60



20x20 - 7^{7/8}"x7^{7/8}"
EGNL Petali ● 60



20x20 - 7^{7/8}"x7^{7/8}"
EGNR Riflesso ● 60



20x20 - 7^{7/8}"x7^{7/8}"
EGNQ Riquadro ● 60



20x20 - 7^{7/8}"x7^{7/8}"
EGNS Ventaglio ● 60

PEZZI SPECIALI

Trims | Peces Speciales | Formteile | Piezas Especiales | Специальные Изделия

	Dimensione Size	Sbiancato	Naturale	Dorato	Tabacco	Fascia di prezzo Price band
 Battiscopa - Skirting	Nat. 4,6x120 - 1 ^{13/16} "x47 ^{1/4} " Pcs. Box. 6 - LM x Box 7,20	EGXJ	EGXK	EGXL	EGXM	● 28

IMBALLI E PESI

Packing and Weight | Emballages et Poids | Verpackung und Gewicht | Embalajes y Pesos | Упаковка и Вес

Formato Size Format Format Tamaño Формат cm	Spessore Thickness Epaisseur Stärke Espesor Толщина mm	Pz. x Mq. Pieces x Sqm Pcs / M ² Stk. x Qm Pzs x Mc. Шт x Кв.М.	Pz. x Scat. Pieces x Box Pcs / Bte Stk. x Krt. Pzs x Caja Шт x Кор.	Mq. x Scat. Sqm x Box M ² / Bte Qm x Krt. Mc. x Caja Кв.М. x Кор.	Peso x Scat. Weight x Box Poids / Bte Gewicht x Krt. Peso x Caja Вес x Кор. Kg	Scat. x Pal. Boxes x Pal. Bte / Pal. Krt. x Pal. Cajas x Pal. Кор. x Подд.	Mq. x Pal. Sqm x Pal. M ² / Pal. Qm x Pal. Mc. x Pal. Кв.М x Подд.	Peso x Pal. Weight x Pal. Poids / Pal. Gewicht x Pal. Peso x Pal. Вес x Подд. Kg
20x120 Naturale	9	4,17	4	0,960	19,48	40	38,40	779
20x20 Decorì	9	25	24	0,960	21,16	54	51,84	1143

ETERNA

FORMATI

Sizes | Formats | Formate | Tamaños | Форматы

 10 mm.

60x120 - 23^{5/8}"x47^{1/4}" Naturale

60x60 - 23^{5/8}"x23^{5/8}" Naturale

30x60 - 11^{13/16}"x23^{5/8}" Naturale

7,5x30 - 2^{15/16}"x11^{13/16}" Naturale

SUPERFICI

Finishes | Finitions | Oberflächen
Superficies | Отделка поверхности

NATURALE

R9 DIN 51130

A DIN 51097

Wet \geq 0,42 ANSI A 137.1- 2012 DCOF (Section 9.6)

\geq 0,40 B.C.R.A.

- AS 4586: 2013

- BS 7976-2: 2002

- ENV 12633-2006

SHADE VARIATIONS



V3 HIGH

DESTINAZIONI D'USO

Intended uses | Domaines d'application
Zweckbestimmung | Usos previstos | Назначение



Ceramics of Italy

放射能水平未満

Min. 7,5%



AVORIO

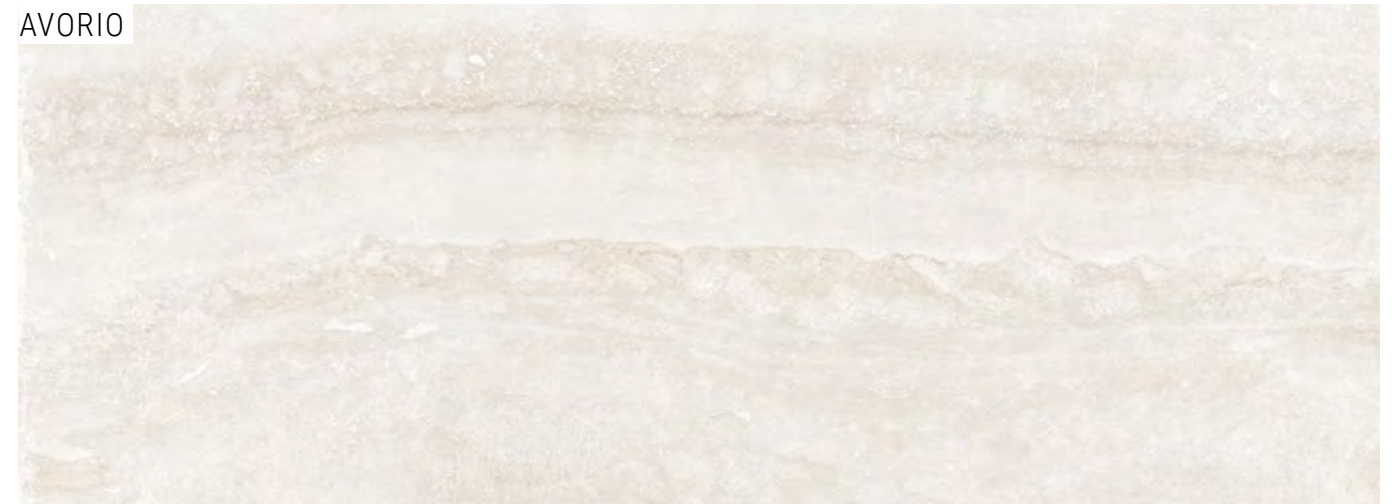

BEIGE



SILVER



TITANIO



ETERNA

COLORI E FORMATI

Colours and Sizes | Couleurs et Formats | Farben und Formate | Colores y Tamaños | Цвета и Форматы

Avorio



Beige



Silver



Titanio



ETERNA

COLORI E FORMATI

Colours and Sizes | Couleurs et Formats | Farben und Formate | Colores y Tamaños | Цвета и Форматы

10 mm.

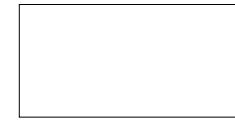

Naturale Rett.

60x120 - 23^{5/8}"x47^{1/4}"

ECJ9 Avorio ● 771

ECJA Beige ● 771

ECJC Silver ● 771

ECJD Titanio ● 771

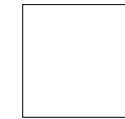

Naturale Rett.

60x60 - 23^{5/8}"x23^{5/8}"

ECHX Avorio ● 662

ECHY Beige ● 662

ECHZ Silver ● 662

ECJ0 Titanio ● 662



Naturale Rett.

30x60 - 11^{13/16}"x23^{5/8}"

ECJ1 Avorio ● 61

ECJ3 Beige ● 61

ECJ5 Silver ● 61

ECJ7 Titanio ● 61



Naturale Rett.

7,5x30 - 2^{15/16}"x11^{13/16}"

ECSA Avorio ● 81

ECSC Beige ● 81

ECSD Silver ● 81

ECSE Titanio ● 81

DECORI

Decors | Decors | Dekore | Decorados | Декоры

DECORO ROME



30x60 - 11^{13/16}"x23^{5/8}"
ECJ2 Avorio Nat. Rett. ● 62



30x60 - 11^{13/16}"x23^{5/8}"
ECJ4 Beige Nat. Rett. ● 62



30x60 - 11^{13/16}"x23^{5/8}"
ECJ6 Silver Nat. Rett. ● 62

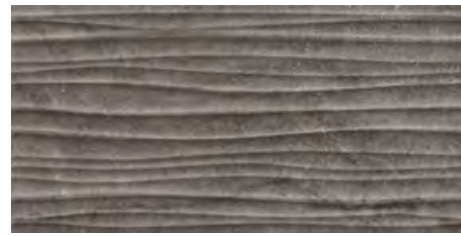

30x60 - 11^{13/16}"x23^{5/8}"
ECJ8 Titanio Nat. Rett. ● 62

MOSAICO 5X5*

Tessera - Chip 4,8x4,8 - 1^{7/8}"x1^{7/8}"

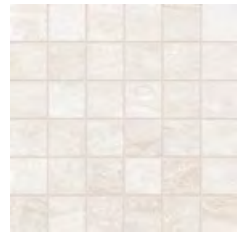

30x30 - 11^{13/16}"x11^{13/16}"
ECM9 Avorio Nat. ● 93

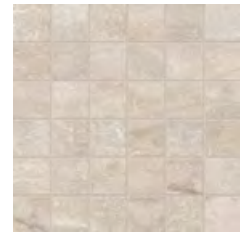

30x30 - 11^{13/16}"x11^{13/16}"
ECMA Beige Nat. ● 93

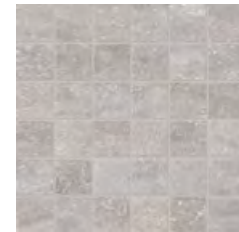

30x30 - 11^{13/16}"x11^{13/16}"
ECMC Silver Nat. ● 93



30x30 - 11^{13/16}"x11^{13/16}"
ECMD Titanio Nat. ● 93

MOSAICO APPIA*

Tessera - Chip 2,5x5 - 1^{5/16}"x1^{7/8}"



30x30 - 11^{13/16}"x11^{13/16}"
ECRR Avorio Nat. ● 100



30x30 - 11^{13/16}"x11^{13/16}"
ECRS Beige Nat. ● 100



30x30 - 11^{13/16}"x11^{13/16}"
ECRT Silver Nat. ● 100



30x30 - 11^{13/16}"x11^{13/16}"
ECRU Titanio Nat. ● 100

* Su rete in fibra - On fibre mesh backing - Sur filet en fibre de verre - Auf Glasfasernetz - Sobre malla de fibra - На волоконной сетке

PEZZI SPECIALI

Trims | Pieces Speciales | Formteile | Piezas Especiales | Специальные Изделия

	Dimensione Size	Avorio		Beige		Silver		Titanio		Fascia di prezzo Price band
Battiscopa - Skirting	Nat. Rett. 7x60 - 2 ^{3/4} "x23 ^{5/8} " Pcs. Box 14 - LM x Box 8,40	ECMP		ECMR		ECMT		ECMV		● 11
Gradino - Stair Tread	Nat. Rett. 33x120 - 12 ^{15/16} "x47 ^{1/4} " Pcs. Box 2 - LM x Box 2,40	ECMK		ECML		ECMM		ECMN		● 90
Gradone - Step	Nat. Rett. 33x120x3,2x3,2 12 ^{15/16} "x47 ^{1/4} "x1 ^{1/4} "x1 ^{1/4} " Pcs. Box 2 - LM x Box 2,40	ECM1		ECM3		ECM5		ECM7		● 95
Angolare Dx Sx Corner Tile Dx Sx	Nat. Rett. 33x120x3,2x3,2 12 ^{15/16} "x47 ^{1/4} "x1 ^{1/4} "x1 ^{1/4} " Pcs. Box 1 - LM x Box 1,20	DX ECLK	SX ECLL	DX ECLP	SX ECLQ	DX ECLT	SX ECLU	DX ECLX	SX ECLY	● 100

IMBALLI E PESI

Packing and Weight | Emballages et Poids | Verpackung und Gewicht | Embalajes y Pesos | Упаковка и Вес

Formato Size Format Format Tamaño Формат cm	Spessore Thickness Epaisseur Stärke Espesor Толщина mm	Pz. x Mq. Pieces x Sqm Pcs / M ² Stk. x Qm Pzs x Mc. Шт x Кв.М.	Pz. x Scat. Pieces x Box Pcs / Bte Stk. x Krt. Pzs x Caja Шт x Кор.	Mq. x Scat. Sqm x Box M ² / Bte Qm x Krt. Mc. x Caja Кв.М. x Кор.	Peso x Scat. Weight x Box Poids / Bte Gewicht x Krt. Peso x Caja Вес x Кор. Kg	Scat. x Pal. Boxes x Pal. Bte / Pal. Krt. x Pal. Cajas x Pal. Кор. x Подд.	Mq. x Pal. Sqm x Pal. M ² / Pal. Qm x Pal. Mc. x Pal. Кв.М x Подд.	Peso x Pal. Weight x Pal. Poids / Pal. Gewicht x Pal. Peso x Pal. Вес x Подд. Kg
60x120 Naturale	10	1,39	2	1,440	34,65	36	51,84	1247
60x60 Naturale	10	2,78	3	1,080	24,36	40	43,20	974
30x60 Naturale - Dec. Rome	10	5,56	6	1,080	24,1	40	43,20	964
7,5x30 Naturale	10	44,44	36	0,810	18,38	56	45,36	1029
30x30 Mosaico 5X5	10	11,11	5	0,450	10,40	60	27,00	624
30x30 Mosaico Appia	10	11,11	5	0,450	12,25	60	27,00	735

EXTERNA

FORMATI

Sizes | Formats | Formate | Tamaños | Форматы

10 mm.

20x40 - 7^{7/8} x 15^{3/4}" Naturale

20x20 - 7^{7/8} x 7^{7/8}" Naturale

SUPERFICI

Finishes | Finitions | Oberflächen
Superficies | Отделка поверхности

■ NATURALE

R11 DIN 51130

C (A+B+C) DIN 51097

Wet \geq 0,65 ANSI A 137.1- 2012 DCOF (Section 9.6)

\geq 0,40 B.C.R.A.

P4 AS 4586: 2013

> 36 Low Slip potential BS 7976-2: 2002

3 ENV 12633-2006

SHADE VARIATIONS



V3 HIGH

DESTINAZIONI D'USO

Intended uses | Domaines d'application
Zweckbestimmung | Usos previstos | Назначение



Ceramics of Italy

放射性水平A类

Min. 7,5%



AVORIO

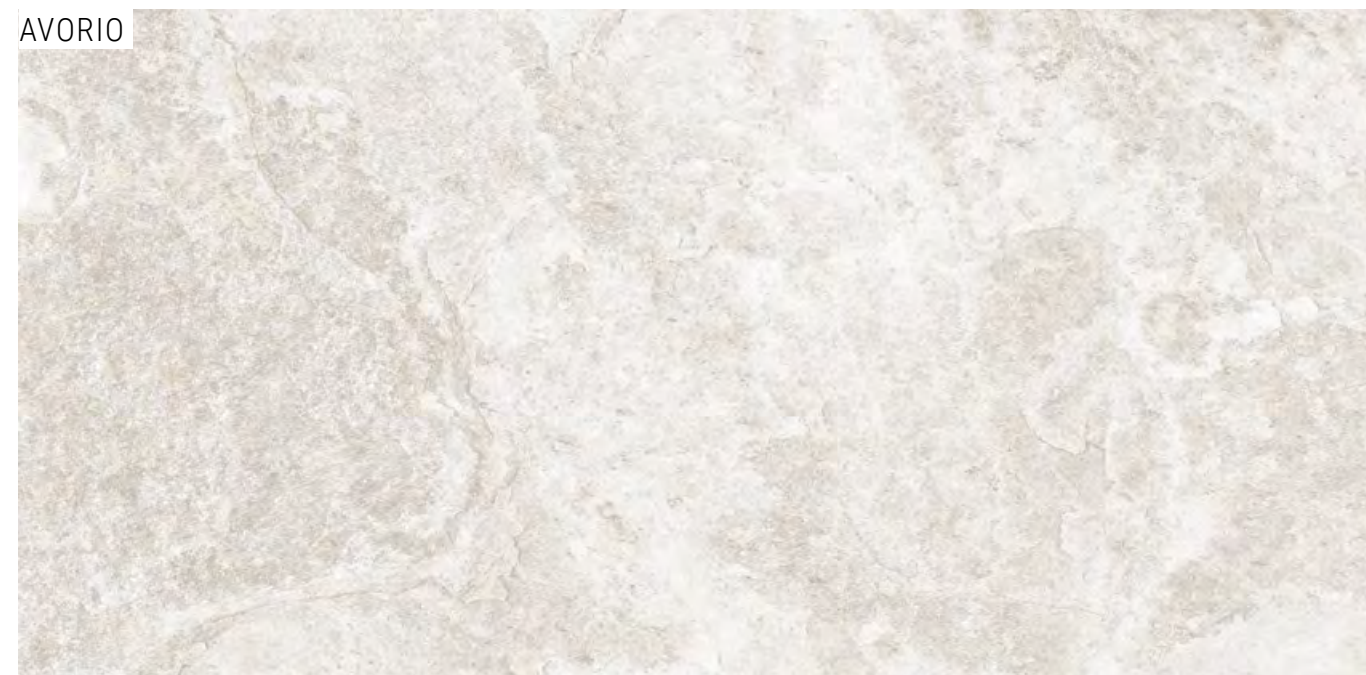

SABBIA



GRIGIO



EXTERNA

COLORI E FORMATI

Colours and Sizes | Couleurs et Formats | Farben und Formate | Colores y Tamaños | Цвета и Форматы

Avorio



Sabbia



Grigio



EXTERNA

COLORI E FORMATI

Colours and Sizes | Couleurs et Formats | Farben und Formate | Colores y Tamaños | Цвета и Форматы

10 mm.



Naturale
20x40 - 7^{7/8}"x15^{3/4}"
EEHM Avorio ● 49
EEHN Sabbia ● 49
EEHP Grigio ● 49





Naturale
20x20 - 7^{7/8}"x7^{7/8}"
EEHF Avorio ● 49
EEHG Sabbia ● 49
EEHH Grigio ● 49

Si consiglia la posa con fuga 2 mm. - Laying with a 2 mm-joint is recommended. - Pose recommandée avec joints de 2 mm.
Es wird eine Fugenbreite von 2 mm empfohlen. - Se recomienda la colocación con juntas de 2 mm. - Рекомендуется укладка с швом 2 мм.

PEZZI SPECIALI

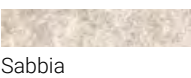
Trims | Pieces Speciales | Formteile | Piezas Especiales | Специальные Изделия

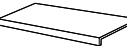
	Dimensione Size				Fascia di prezzo Price band
 Battiscopa - Skirting	Nat. Rett. 7x60 - 2 ^{3/4} "x23 ^{5/8} " Pcs. Box 14 - LM x Box 8,40	EFAJ	EFAK	EFAL	● 11
 Elemento a "L" - L Shaped Piece	Nat. 15x30x3,8 5 ^{7/8} "x11 ^{13/16} "x1 ^{1/2} " Pcs. Box 6 - LM x Box 1,80	EFAC	EFAD	EFAE	● 21

IMBALLI E PESI

Packing and Weight | Emballages et Poids | Verpackung und Gewicht | Embalajes y Pesos | Упаковка и Вес

Formato Size Format Format Тamaño Формат cm	Spessore Thickness Épaisseur Stärke Espesor Толщина mm	Pz. x Mq. Pieces x Sqm Pcs / M ² Stk. x Qm Pzs x Mc. Шт x Кв.М.	Pz. x Scat. Pieces x Box Pcs / Bte Stk. x Krt. Pzs x Caja Шт x Кор.	Mq. x Scat. Sqm x Box M ² / Bte Qm x Krt. Mc. x Caja Кв.М. x Кор.	Peso x Scat. Weight x Box Poids / Bte Gewicht x Krt. Peso x Caja Вес x Кор.	Scat. x Pal. Boxes x Pal. Bte / Pal. Krt. x Pal. Cajas x Pal. Кор. x Подд.	Mq. x Pal. Sqm x Pal. M ² / Pal. Qm x Pal. Mc. x Pal. Кв.М x Подд.	Peso x Pal. Weight x Pal. Poids / Pal. Gewicht x Pal. Peso x Pal. Вес x Подд. Kg
20x40 Naturale	10	12,5	12	0,960	21,14	54	51,84	1142
20x20 Naturale	10	25	24	0,960	20,56	54	51,84	1110

EXTERNA | COTTO

FORMATI

Sizes | Formats | Formate | Tamaños | Форматы

10 mm.

20x40 - 7^{7/8} x 15^{3/4} Naturale

20x20 - 7^{7/8} x 7^{7/8} Naturale

SUPERFICI

Finishes | Finitions | Oberflächen
Superficies | Отделка поверхности

NATURALE

R11 DIN 51130

C (A+B+C) DIN 51097

Wet \geq 0,65 ANSI A 137.1- 2012 DCOF (Section 9.6)

\geq 0,40 B.C.R.A.

P4 AS 4586: 2013

> 36 Low Slip potential BS 7976-2: 2002

3 ENV 12633-2006

SHADE VARIATIONS



V3 HIGH

DESTINAZIONI D'USO

Intended uses | Domaines d'application
Zweckbestimmung | Usos previstos | Назначение



Ceramics of Italy

放射能水平A类

Min. 7,5%

MATTONE



OCRA



CENERE



EXTERNA COTTO

COLORI E FORMATI

Colours and Sizes | Couleurs et Formats | Farben und Formate | Colores y Tamaños | Цвета и Форматы

Mattone



Ocra



Cenere



EXTERNA COTTO

COLORI E FORMATI

Colours and Sizes | Couleurs et Formats | Farben und Formate | Colores y Tamaños | Цвета и Форматы



Naturale
20x40 - 7^{7/8}"x15^{3/4}"
EGKH Mattone ● 49
EGKK Ocra ● 49
EGKJ Cenere ● 49





Naturale
20x20 - 7^{7/8}"x7^{7/8}"
EGKD Mattone ● 49
EGKF Ocra ● 49
EGKE Cenere ● 49

Si consiglia la posa con fuga 2 mm. - Laying with a 2 mm-joint is recommended. - Pose recommandée avec joints de 2 mm.
Es wird eine Fugenbreite von 2 mm empfohlen. - Se recomienda la colocación con juntas de 2 mm. - Рекомендуется укладка с швом 2 мм.

PEZZI SPECIALI

Trims | Pieces Speciales | Formteile | Piezas Especiales | Специальные Изделия

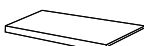
	Dimensione Size	 Mattone	 Ocra	 Cenere	Fascia di prezzo Price band
 Battiscopa - Skirting	Nat. 6x40 - 2 ^{3/8} "x15 ^{3/4} " Pcs. Box 20 - LM x Box 8,00	EGKM	EGKP	EGKN	● 9
 Elemento a "L"- L Shaped Piece	Nat. 15x30x3,8 5 ^{7/8} "x11 ^{13/16} "x1 ^{1/2} " Pcs. Box 6 - LM x Box 1,80	EGKR	EGKT	EGKS	● 21

IMBALLI E PESI

Packing and Weight | Emballages et Poids | Verpackung und Gewicht | Embalajes y Pesos | Упаковка и Вес

Formato Size Format Format Тamaño Формат cm	Spessore Thickness Epaisseur Stärke Espesor Толщина mm	Pz. x Mq. Pieces x Sqm Pcs / M ² Stk. x Qm Pzs x Mc. Шт x Кв.М.	Pz. x Scat. Pieces x Box Pcs / Bte Stk. x Krt. Pzs x Caja Шт x Кор.	Mq. x Scat. Sqm x Box M ² / Bte Qm x Krt. Mc. x Caja Кв.М. x Кор.	Peso x Scat. Weight x Box Poids / Bte Gewicht x Krt. Peso x Caja Вес x Кор.	Scat. x Pal. Boxes x Pal. Bte / Pal. Krt. x Pal. Cajas x Pal. Кор. x Подд.	Mq. x Pal. Sqm x Pal. M ² / Pal. Qm x Pal. Mc. x Pal. Кв.М x Подд.	Peso x Pal. Weight x Pal. Poids / Pal. Gewicht x Pal. Peso x Pal. Вес x Подд. Kg
20x40 Naturale	10	12,5	12	0,960	21,24	54	51,84	1147
20x20 Naturale	10	25	24	0,960	20,84	54	51,84	1125

EXTERNA | QUARZITE

FORMATI

Sizes | Formats | Formate | Tamaños | Форматы

 10 mm.

20x40 - 7⁷/₈" x 15³/₄" Naturale

20x20 - 7⁷/₈" x 7⁷/₈" Naturale

SUPERFICI

Finishes | Finitions | Oberflächen
Superficies | Отделка поверхности

■ NATURALE

R11 DIN 51130

C (A+B+C) DIN 51097

Wet \geq 0,65 ANSI A 137.1- 2012 DCOF (Section 9.6)

\geq 0,40 B.C.R.A.

P4 AS 4586: 2013

> 36 Low Slip potential BS 7976-2: 2002

3 ENV 12633-2006

SHADE VARIATIONS



V3 HIGH

DESTINAZIONI D'USO

Intended uses | Domaines d'application
Zweckbestimmung | Usos previstos | Назначение



Ceramics of Italy



放射能水平A类



Min. 7,5%



GOLD GREY



RUST GREY



EXTERNA QUARZITE

COLORI E FORMATI

Colours and Sizes | Couleurs et Formats | Farben und Formate | Colores y Tamaños | Цвета и Форматы

Gold Grey



Rust Grey



EXTERNA QUARZITE

COLORI E FORMATI

Colours and Sizes | Couleurs et Formats | Farben und Formate | Colores y Tamaños | Цвета и Форматы



Naturale
20x40 - 7^{7/8}"x15^{3/4}"
EGL1 Gold Grey ● 49
EGL2 Rust Grey ● 49



Naturale
20x20 - 7^{7/8}"x7^{7/8}"
EGKV Gold Grey ● 49
EGKW Rust Grey ● 49

Si consiglia la posa con fuga 2 mm. - Laying with a 2 mm-joint is recommended. - Pose recommandée avec joints de 2 mm.
Es wird eine Fugenbreite von 2 mm empfohlen. - Se recomienda la colocación con juntas de 2 mm. - Рекомендуется укладка с швом 2 мм.

PEZZI SPECIALI

Trims | Pieces Speciales | Formteile | Piezas Especiales | Специальные Изделия

	Dimensione Size	 Gold Grey	 Rust Grey	Fascia di prezzo Price band
 Battiscopa - Skirting	Nat. 6x40 - 2 ^{3/8} "x15 ^{3/4} " Pcs. Box 20 - LM x Box 8	EGL4	EGL5	● 9
 Elemento a "L" - L Shaped Piece	Nat. 15x30x3,8 5 ^{7/8} "x11 ^{13/16} "x1 ^{1/2} " Pcs. Box 6 - LM x Box 1,80	EGL7	EGL8	● 21

IMBALLI E PESI

Packing and Weight | Emballages et Poids | Verpackung und Gewicht | Embalajes y Pesos | Упаковка и Вес

Formato Size	Spessore Thickness	Pz. x Mq. Pieces x Sqm	Pz. x Scat. Pieces x Box	Mq. x Scat. Sqm x Box	Peso x Scat. Weight x Box	Scat. x Pal. Boxes x Pal.	Mq. x Pal. Sqm x Pal.	Peso x Pal. Weight x Pal.
Format	Epaisseur	Pcs / M ²	Pcs / Bte	M ² / Bte	Poids / Bte	Bte / Pal.	M ² / Pal.	Poids / Pal.
Format	Stärke	Stk. x Qm	Stk. x Krt.	Qm x Krt.	Gewicht x Krt.	Krt. x Pal.	Qm x Pal.	Gewicht x Pal.
Tamaño	Espesor	Pzs x Mc.	Pzs x Caja	Mc. x Caja	Peso x Caja	Cajas x Pal.	Mc. x Pal.	Peso x Pal.
Формат	Толщина	Шт x Кв.М.	Шт x Кор.	Кв.М. x Кор.	Вес x Кор.	Кор. x Подд.	Кв.М x Подд.	Вес x Подд.
cm	mm				Kg			Kg
20x40 Naturale	10	12,5	12	0,960	21,07	54	51,84	1138
20x20 Naturale	10	25	24	0,960	20,63	54	51,84	1114

Kotto

FORMATI

Sizes | Formats | Formate | Tamaños | Форматы

9 mm.

30x60 - 11^{13/16}"x23^{5/8}" Naturale

30x30 - 11^{13/16}"x11^{13/16}" Naturale

12,5x25 - 4^{15/16}"x9^{13/16}" Brick Naturale

6x25 - 2^{3/8}"x9^{13/16}" Brick Naturale

10 mm.

80x80 - 31^{1/2}"x31^{1/2}" Naturale

40x80 - 15^{3/4}"x31^{1/2}" Naturale

60x60 - 23^{5/8}"x23^{5/8}" Naturale - Antislip

SUPERFICI

Finishes | Finitions | Oberflächen
Superficies | Отделка поверхности

■ NATURALE

R10 DIN 51130

B (A+B) DIN 51097

Wet $\geq 0,50$ ANSI A 137.1- 2012 DCOF (Section 9.6)

$\geq 0,40$ B.C.R.A.

P2 AS 4586: 2013

< 36 Moderate Slip potential BS 7976-2: 2002

2 ENV 12633-2006

■ BRICK NATURALE | ANTISLIP

R11 DIN 51130

C (A+B+C) DIN 51097

Wet $\geq 0,42$ ANSI A 137.1- 2012 DCOF (Section 9.6)

$\geq 0,50$ B.C.R.A.

P2 AS 4586: 2013

> 36 Low Slip potential BS 7976-2: 2002

2 ENV 12633-2006

SHADE VARIATIONS



DESTINAZIONI D'USO

Intended uses | Domaines d'application
Zweckbestimmung | Usos previstos | Назначение



GESSO (solo 6x25 e 12,5x25)

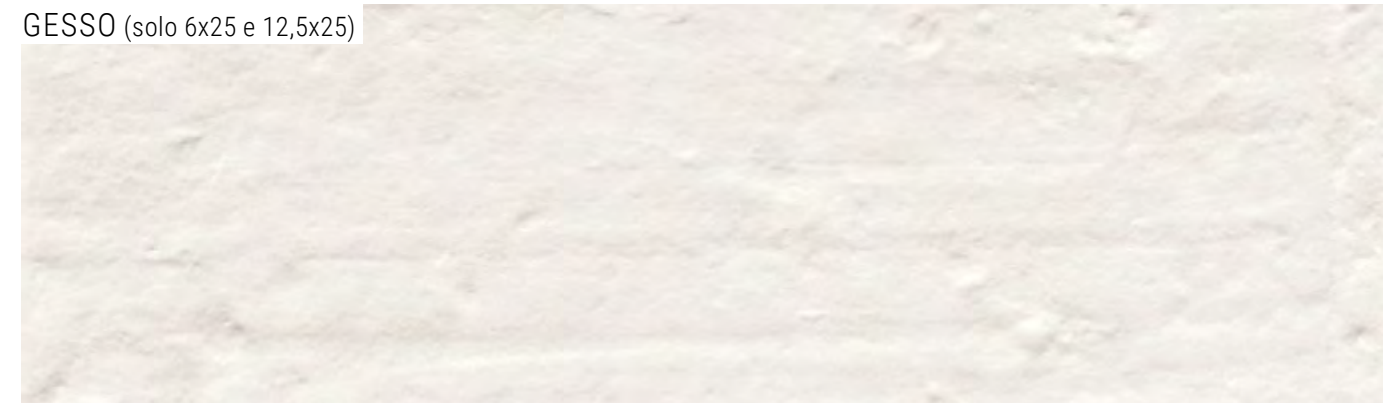

CALCE



AVANA

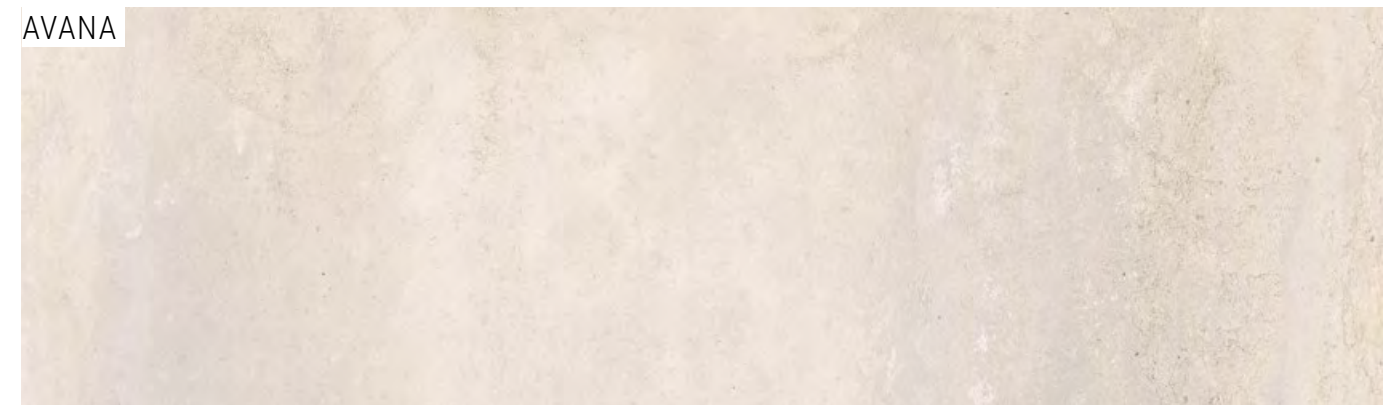

TERRA



CENERE

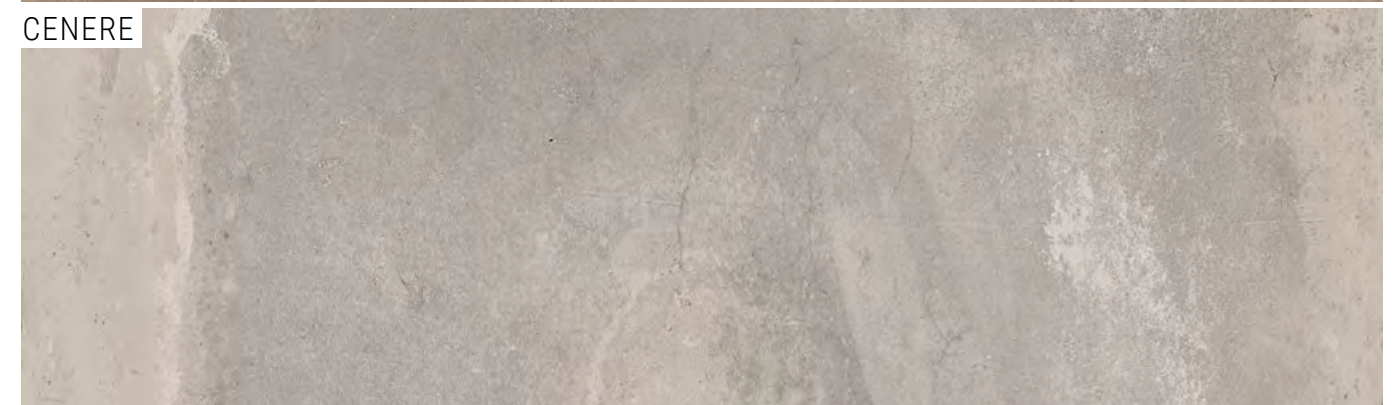

COLORI E FORMATI

Colours and Sizes | Couleurs et Formats | Farben und Formate | Colores y Tamaños | Цвета и Форматы

Gesso (solo 6x25 e 12,5x25)



Calce



Avana

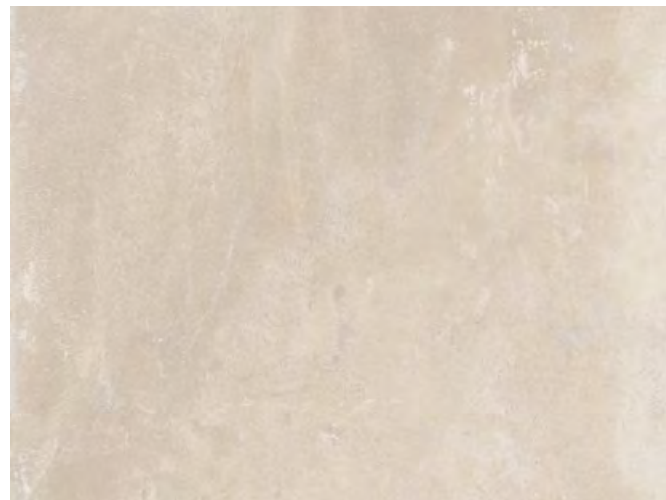

Terra

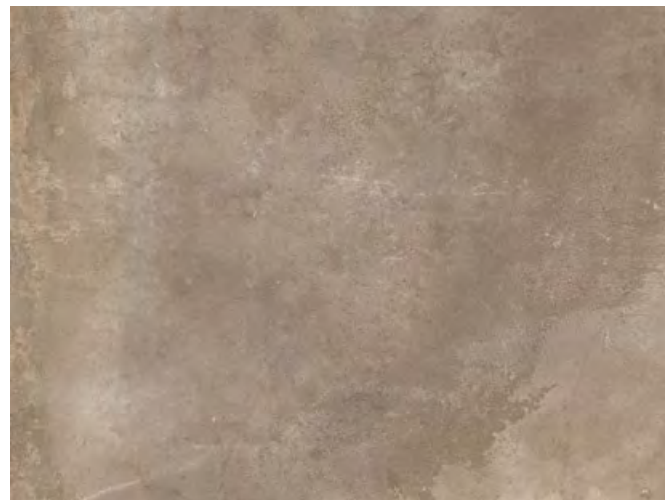







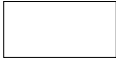

Cenere

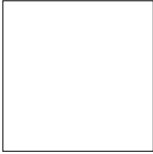

COLORI E FORMATI

Colours and Sizes | Couleurs et Formats | Farben und Formate | Colores y Tamaños | Цвета и Форматы

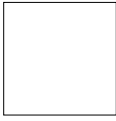
	9 mm.	Kotto XS	
		Naturale Rett. 30x60 - 11 ^{13/16} "x23 ^{5/8} "	
		E30M Calce	● 61
		E308 Avana	● 61
		E309 Terra	● 61
		E30A Cenere	● 61
		Naturale Rett. 30x30 - 11 ^{13/16} "x11 ^{13/16} "	
		E30K Calce	● 61
		E300 Avana	● 61
		E301 Terra	● 61
		E302 Cenere	● 61
	9 mm.	Kotto Brick	
		Brick Naturale 12,5x25 - 4 ^{15/16} "x9 ^{13/16} "	
		E2ZU Gesso	● 60
		E30J Calce	● 60
		E2ZW Avana	● 60
		E2ZX Terra	● 60
		E2ZY Cenere	● 60
		Brick Naturale 6x25 - 2 ^{3/8} "x9 ^{13/16} "	
		E30W Gesso	● 60
		E30X Calce	● 60
		E30Z Avana	● 60
		E310 Terra	● 60
		E311 Cenere	● 60
	10 mm.	Kotto XL	
		Naturale Rett. 80x80 - 31 ^{1/2} "x31 ^{1/2} "	
		E30N Calce	● 78
		E30D Avana	● 78
		E30E Terra	● 78
		E30F Cenere	● 78
		Naturale Rett. 40x80 - 15 ^{3/4} "x31 ^{1/2} "	
		E325 Calce	● 74
		E327 Avana	● 74
		E328 Terra	● 74
		E329 Cenere	● 74
		Naturale Rett. 60x60 - 23 ^{5/8} "x23 ^{5/8} "	
		E30L Calce	● 662
		E304 Avana	● 662
		E305 Terra	● 662
		E306 Cenere	● 662
		Antislip Rett. 60x60 - 23 ^{5/8} "x23 ^{5/8} "	
		E3GW Avana	● 662
		E3GX Cenere	● 662

Si consiglia la posa con fuga 2 mm. - Laying with a 2 mm-joint is recommended. - Pose recommandée avec joints de 2 mm.
Es wird eine Fugenbreite von 2 mm empfohlen. - Se recomienda la colocación con juntas de 2 mm. - Рекомендуется укладка с швом 2 мм.

KOTTO

DECORI

Decors | Decors | Dekore | Decorados | Декоры

10 mm. DEKÒ ART KOTTO XL



20x20 - 7⁷/₈"x7⁷/₈"

E51C Calce Nat. Rett.

● 85



20x20 - 7⁷/₈"x7⁷/₈"

E32S Avana Nat. Rett.

● 85



20x20 - 7⁷/₈"x7⁷/₈"

E7PU Terra Nat. Rett.

● 85

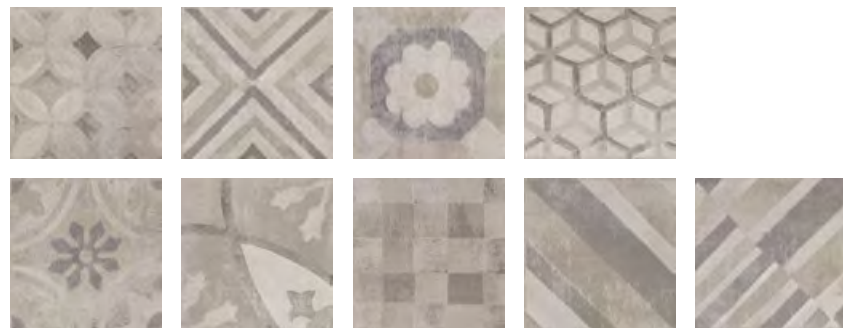

20x20 - 7⁷/₈"x7⁷/₈"

E7PW Cenere Nat. Rett.

● 85

KOTTO

DECORI

Decors | Decors | Dekore | Decorados | Декоры

10 mm. DEKÒ TEXTURE KOTTO XL



20x20 - 7⁷/₈"x7⁷/₈"

E7PQ Calce Nat. Rett.

● 85



20x20 - 7⁷/₈"x7⁷/₈"

E32U Avana Nat. Rett.

● 85

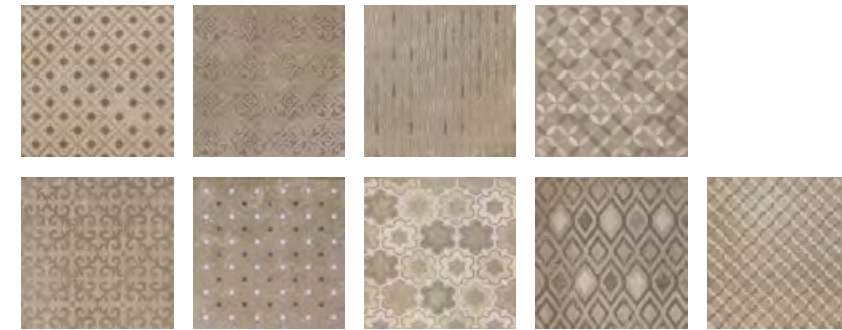

20x20 - 7⁷/₈"x7⁷/₈"

E32V Terra Nat. Rett.

● 85

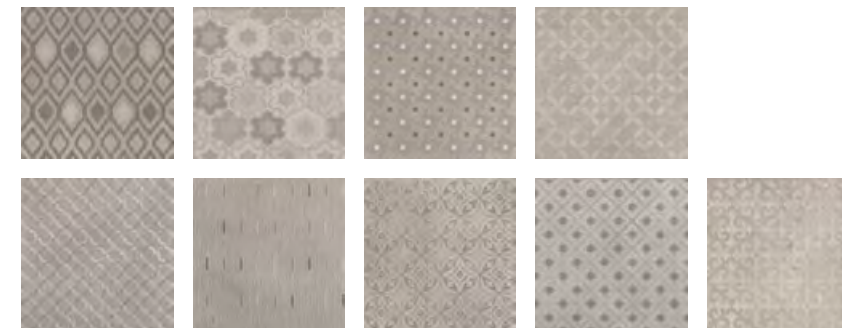

20x20 - 7⁷/₈"x7⁷/₈"

E32W Cenere Nat. Rett.

● 85

KOTTO

DECORI

Decors | Decors | Dekore | Decorados | Декоры

10 mm. MOSAICO 5X5* KOTTO XL

Tessera - Chip 4,8x4,8 - 1^{7/8}x1^{7/8}"

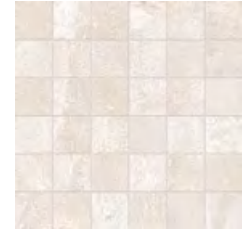

30x30 - 11^{13/16}"x11^{13/16}"
E344 Calce Nat. ● 93

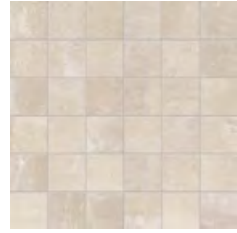

30x30 - 11^{13/16}"x11^{13/16}"
E346 Avana Nat. ● 93

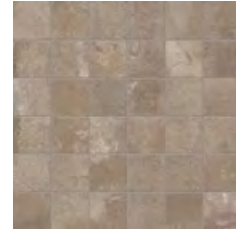

30x30 - 11^{13/16}"x11^{13/16}"
E347 Terra Nat. ● 93



30x30 - 11^{13/16}"x11^{13/16}"
E348 Cenere Nat. ● 93

9 mm. MOSAICO 5X5* KOTTO XS

Tessera - Chip 4,8x4,8 - 1^{7/8}x1^{7/8}"

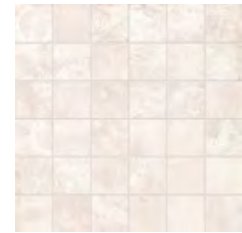

30x30 - 11^{13/16}"x11^{13/16}"
E312 Calce Nat. ● 93



30x30 - 11^{13/16}"x11^{13/16}"
E314 Avana Nat. ● 93

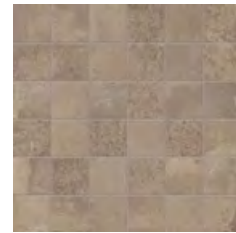

30x30 - 11^{13/16}"x11^{13/16}"
E315 Terra Nat. ● 93

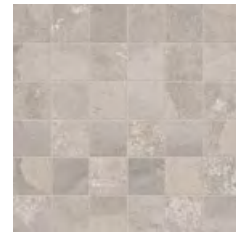

30x30 - 11^{13/16}"x11^{13/16}"
E316 Cenere Nat. ● 93

* Su rete in fibra - On fibre mesh backing - Sur filet en fibre de verre - Auf Glasfasernetz - Sobre malla de fibra - На волоконной сетке

KOTTO

10 mm. PEZZI SPECIALI KOTTO XL

Trims | Pieces Speciales | Formteile | Piezas Especiales | Специальные Изделия

	Dimensione Size	Calce	Avana	Terra	Cenere	Fascia di prezzo Price band
Battiscopa - Skirting	Nat. Rett. 7x60 - 2 ^{3/4} "x23 ^{5/8} " Pcs. Box 14 - LM x Box 8,40	E317	E319	E31A	E31C	● 11
	Nat. Rett. 4,6x60 - 1 ^{13/16} "x23 ^{5/8} " Pcs. Box 20 - LM x Box 12	E3AH	E3AK	E3AL	E9LF	● 11
Gradino - Stair Tread	Nat. Rett. 33x60 - 12 ^{15/16} "x23 ^{5/8} " Pcs. Box 6 - LM x Box 3,60	E9AW	E9AY	E9AZ	E9C0	● 61
	Nat. Rett. 33x60x3,2x3,2 12 ^{15/16} "x23 ^{5/8} "x1 ^{1/4} "x1 ^{1/4} " Pcs. Box 4 - LM x Box 2,40	E9AF	E9AH	E9AJ	E9AK	● 79
Angolare - Corner Tile	Nat. Rett. 33x33x3,2x3,2 12 ^{15/16} "x12 ^{15/16} "x1 ^{1/4} "x1 ^{1/4} " Pcs. Box 2 - LM x Box 0,66	E9A9	E9AC	E9AD	E9AE	● 83
	Nat. Rett. 15x60x5 5 ^{7/8} "x23 ^{5/8} "x1 ^{15/16} " Pcs. Box 4 - LM x Box 2,40	E31H	E31K	E31L	E31M	● 43

9 mm. PEZZI SPECIALI KOTTO XS

Trims | Pieces Speciales | Formteile | Piezas Especiales | Специальные Изделия

KOTTO XS	Dimensione Size	Calce	Avana	Terra	Cenere	Fascia di prezzo Price band
Battiscopa - Skirting	Nat. Rett. 7x60 - 2 ^{3/4} "x23 ^{5/8} " Pcs. Box 14 - LM x Box 8,40	E3DE	E3DG	E3DH	E9MH	● 11
	Nat. Rett. 4,6x60 - 1 ^{13/16} "x23 ^{5/8} " Pcs. Box 20 - LM x Box 12	E3AM	E3AP	E3AQ	E3AR	● 11
Gradino - Stair Tread	Nat. Rett. 30x60 - 11 ^{13/16} "x23 ^{5/8} " Pcs. Box 6 - LM x Box 3,60	E9C1	E9C3	E9C4	E9C5	● 46
	Nat. Rett. 30x60x3,2x3,2 11 ^{13/16} "x23 ^{5/8} "x1 ^{1/4} "x1 ^{1/4} " Pcs. Box 4 - LM x Box 2,40	E9AR	E9AT	E9AU	E9AV	● 76
Angolare - Corner Tile	Nat. Rett. 30x30x3,2x3,2 11 ^{13/16} "x11 ^{13/16} "x1 ^{1/4} "x1 ^{1/4} " Pcs. Box 2 - LM x Box 0,60	E9AL	E9AN	E9AP	E9AQ	● 781
	Nat. Rett. 15x60x5 5 ^{7/8} "x23 ^{5/8} "x1 ^{15/16} " Pcs. Box 4 - LM x Box 2,40	E31H	E31K	E31L	E31M	● 43

9 mm. PEZZI SPECIALI KOTTO BRICK

Trims | Peces Speciales | Formteile | Piezas Especiales | Специальные Изделия

	Dimensione Size	Gesso	Calce	Avana	Terra	Cenere	Fascia di prezzo Price band
 Brick Angolare - Brick Corner	Nat. (AxBxC) 12,5x19x6 4 ^{15/16} x7 ^{1/2} x2 ^{3/8} " Pcs. Box 6	E9FT	E9FU	E9FW	E392	E9FX	● 30
 Brick Angolare - Brick Corner	Nat. (AxBxC) 6x25x12,5 2 ^{3/8} x9 ^{13/16} x4 ^{15/16} " Pcs. Box 12	E38X	E38Y	E390	E391	E9FS	● 27
 Becco Civetta - Bullnose	Nat. 6x25 - 2 ^{3/8} x9 ^{13/16} " Pcs. Box 34	E396	E377	E378	E9EZ	E379	● 7
 Cove Base*	Nat. 16x30 - 6 ^{5/16} x11 ^{13/16} " Pcs. Box 30	E9GF	E9C6	E31E	E31F	E31G	● 28
 Cove Base Ang. Int.* Cove Base In Corner	Nat. 2,5x16 - 1 ^{5/16} x6 ^{5/16} " Pcs. Box 10	E9FZ	E9C7	E31U	E31V	E31W	● 26
 Cove Base Ang. Est.* Cove Base Out Corner	Nat. 2,5x16 - 1 ^{5/16} x6 ^{5/16} " Pcs. Box 10	E9FY	E31N	E31Q	E31R	E31S	● 26

*Ordine minimo 500 pezzi - Minimum order: 500 pieces - Commande minimale 500 pièces
Mindestbestellmenge 500 Stücke - Pedido mínimo 500 piezas - Минимальный заказ - 500 штук

IMBALLI E PESI

Packing and Weight | Emballages et Poids | Verpackung und Gewicht | Embalajes y Pesos | Упаковка и Вес

Formato Size Format Format Тamaño Формат cm	Spessore Thickness Epaisseur Stärke Espesor Толщина mm	Pz. x Mq. Pieces x Sqm Pcs / M ² Stk. x Qm Pzs x Mc. Шт x Кв.М.	Pz. x Scat. Pieces x Box Pcs / Bte Stk. x Krt. Pzs x Caja Шт x Кор.	Mq. x Scat. Sqm x Box M ² / Bte Qm x Krt. Mc. x Caja Кв.М. x Кор.	Peso x Scat. Weight x Box Poids / Bte Gewicht x Krt. Peso x Caja Вес x Кор. Kg	Scat. x Pal. Boxes x Pal. Bte / Pal. Krt. x Pal. Cajas x Pal. Кор. x Подд.	Mq. x Pal. Sqm x Pal. M ² / Pal. Qm x Pal. Mc. x Pal. Кв.М x Подд.	Peso x Pal. Weight x Pal. Poids / Pal. Gewicht x Pal. Peso x Pal. Вес x Подд. Kg
80x80 Naturale	10	1,56	2	1,280	28,64	42	53,76	1203
40x80 Naturale	10	3,13	3	0,960	21,14	28	26,88	592
60x60 Naturale - Antislip	10	2,78	3	1,080	24,06	40	43,20	962
30x60 Naturale	9	5,56	7	1,260	24,04	40	50,4	962
30x30 Naturale	9	11,11	14	1,260	24,12	40	50,4	965
12,5x25 Naturale	9	32,00	26	0,810	14,11	81	65,6	1143
6x25 Naturale	9	66,67	34	0,510	9,29	99	50,49	920
30x30 Mosaico 5X5 XL	10	11,11	5	0,450	9,80	60	27,00	588
30x30 Mosaico 5X5 XS	9	11,11	5	0,450	9,80	60	27,00	588
20x20 Dekò	10	25,00	17	0,680	13,48	72	48,96	971



Cenere Nat. Rett.
80x80 - 31^{1/2}x31^{1/2}"

Cenere Nat. Rett.
40x80 - 15^{3/4}x31^{1/2}"

Dekò Texture Cenere Nat. Rett.
20x20 - 7^{7/8}x7^{7/8}"

MILLELEGGNI

FORMATI

Sizes | Formats | Formate | Tamaños | Форматы

 10 mm.

30x120 - 11^{13/16}"x47^{1/4}" Naturale

20x120 - 7^{7/8}"x47^{1/4}" Naturale

15x120 - 5^{7/8}"x47^{1/4}" Naturale

20MM

40x120 - 15^{3/4}"x47^{1/4}" Naturale

SUPERFICI

Finishes | Finitions | Oberflächen
Superficies | Отделка поверхности

■ NATURALE

R10 DIN 51130

B (A+B) DIN 51097

Wet \geq 0,50 ANSI A 137.1- 2012 DCOF (Section 9.6)

\geq 0,40 B.C.R.A.

P2 AS 4586: 2013

< 36 High Slip potential BS 7976-2: 2002

- ENV 12633-2006

■ 20MM

R11 DIN 51130

C (A+B+C) DIN 51097

Wet \geq 0,65 ANSI A 137.1- 2012 DCOF (Section 9.6)

\geq 0,40 B.C.R.A.

P4 AS 4586: 2013

> 36 Low Slip potential BS 7976-2: 2002

3 ENV 12633-2006

SHADE VARIATIONS



V3 HIGH



Noce Selvatico



V4 RANDOM

DESTINAZIONI D'USO

Intended uses | Domaines d'application
Zweckbestimmung | Usos previstos | Назначение



Min. 7,5%



UPEC-F+

20MM



001 WHITE TOULIPIER



002 SCOTTISH OAK



003 NOCE SELVATICO

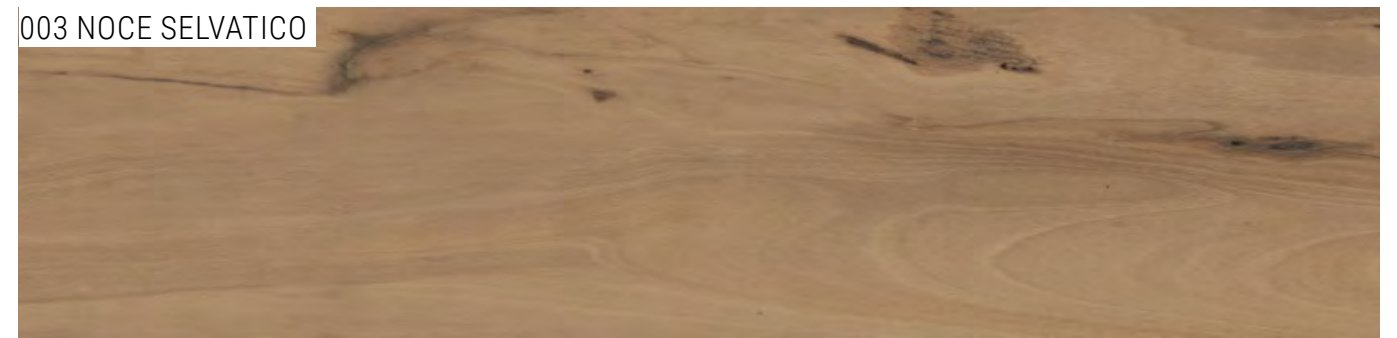

004 GREY ASH

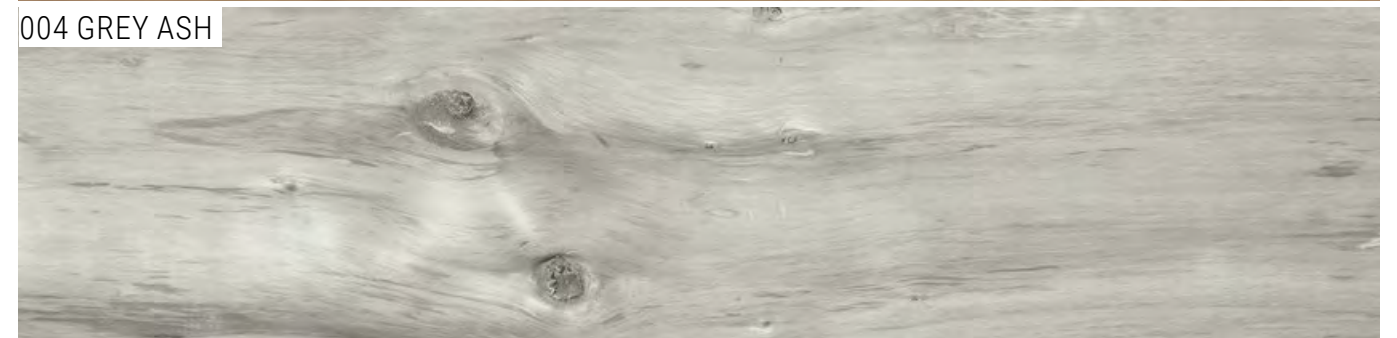

005 LARCH



006 ABETE OSSIDATO



MILLELEGNI

COLORI E FORMATI

Colours and Sizes | Couleurs et Formats | Farben und Formate | Colores y Tamaños | Цвета и Форматы

001 White Toulipier



002 Scottish Oak



003 Noce Selvatico



004 Grey Ash



005 Larch

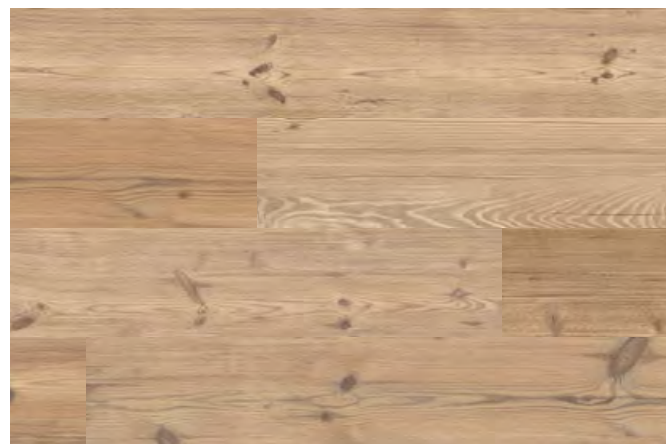

006 Abete Ossidato

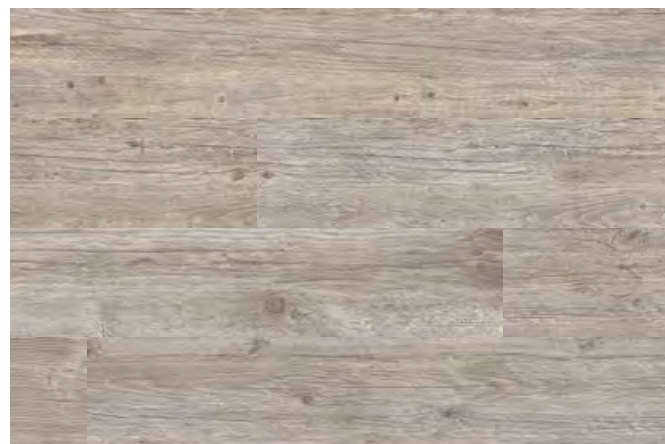

MILLELEGNI

COLORI E FORMATI

Colours and Sizes | Couleurs et Formats | Farben und Formate | Colores y Tamaños | Цвета и Форматы

10 mm.



Naturale Rett.

30x120 - 11^{13/16}"x47^{1/4}"

- E21Y 001 White Toulipier ● 781
- E21Z 002 Scottish Oak ● 781
- E24H 003 Noce Selvatico ● 781
- E220 004 Grey Ash ● 781
- E2NZ 005 Larch ● 781
- E2P0 006 Abete Ossidato ● 781



Naturale Rett.

20x120 - 7^{7/8}"x47^{1/4}"

- E21V 001 White Toulipier ● 79
- E21W 002 Scottish Oak ● 79
- E24G 003 Noce Selvatico ● 79
- E21X 004 Grey Ash ● 79
- E2NX 005 Larch ● 79
- E2NY 006 Abete Ossidato ● 79



Naturale Rett.

15x120 - 5^{7/8}"x47^{1/4}"

- E21R 001 White Toulipier ● 79
- E21S 002 Scottish Oak ● 79
- E24F 003 Noce Selvatico ● 79
- E21T 004 Grey Ash ● 79
- E2NU 005 Larch ● 79
- E2NV 006 Abete Ossidato ● 79

20MM

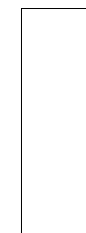

Naturale Rett.











40x120 - 15^{3/4}"x47^{1/4}"

- E37Q 002 Scottish Oak U_{3s}P₃E₃C₂F₊ ● 89

Si consiglia la posa con fuga 2 mm. - Laying with a 2 mm-joint is recommended. - Pose recommandée avec joints de 2 mm.
Es wird eine Fugenbreite von 2 mm empfohlen. - Se recomienda la colocación con juntas de 2 mm. - Рекомендуется укладка с швом 2 мм.



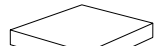









PEZZI SPECIALI

Trims | Pieces Speciales | Formteile | Piezas Especiales | Специальные Изделия

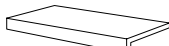
	Dimensione Size	 001 White Toulipier	 002 Scottish Oak	 003 Noce Selvatico	 004 Grey Ash	 005 Larch	 006 Abete Ossidato	Fascia di prezzo Price band
	Nat. Rett. 7x60 - 2 ^{3/4} x23 ^{5/8} Pcs. Box 14 - LM x Box 8,4	E297	E298	E299	E29A	E2VP	E2VQ	● 15
	Nat. Rett. 7x120 - 2 ^{3/4} x47 ^{1/4} Pcs. Box 6 - LM x Box 7,20	E291	E292	E293	E294	E2VL	E2VM	● 39
	Nat. Rett. 33x120x3,2x3,2 12 ^{15/16} x47 ^{1/4} x1 ^{1/4} x1 ^{1/4} Pcs. Box. 2 - LM x Box 2,40	E8FG	E8FH	E8FJ	E8FK	E91S	E91T	● 95
	Nat. Rett. 33x120x3,2x3,2 12 ^{15/16} x47 ^{1/4} x1 ^{1/4} x1 ^{1/4} Pcs. Box. 1 - LM x Box 1,20	DX E8EH	DX E8EK	DX E8EM	DX E8EP	DX E912	DX E914	● 100
		SX E8EJ	SX E8EL	SX E8EN	SX E8EQ	SX E913	SX E915	
	Nat. Rett. 33x33x3,2x3,2 12 ^{15/16} x12 ^{15/16} x1 ^{1/4} x1 ^{1/4} Pcs. Box 2 - LM x Box 0,66	DX E8FY	DX E8G0	DX E8G2	DX E8G4	DX E936	DX E938	● 83
		SX E8FZ	SX E8G1	SX E8G3	SX E8G5	SX E937	SX E939	
	Nat. Rett. 7x60x60 2 ^{3/4} x23 ^{5/8} x23 ^{5/8} Pcs. Box 2 - LM x Box 1,20	-	DX E9FA	-	-	-	-	● 42
		-	SX E9FC	-	-	-	-	
	Nat. Rett. 7x60x60 2 ^{3/4} x23 ^{5/8} x23 ^{5/8} Pcs. Box 2 - LM x Box 1,20	-	DX E9FD	-	-	-	-	● 42
		-	SX E9FE	-	-	-	-	

20MM PEZZI SPECIALI

Trims | Pieces Speciales | Formteile | Piezas Especiales | Специальные Изделия

	Dimensione Size	 001 White Toulipier	 002 Scottish Oak	 003 Noce Selvatico	 004 Grey Ash	 005 Larch	 006 Abete Ossidato	Fascia di prezzo Price band
	Nat. Rett. 33x120x5 12 ^{15/16} x47 ^{1/4} x1 ^{15/16} Pcs. Box 1 - LM x Box 1,20	-	E9FF	-	-	-	-	● 98
	Nat. Rett. 33x120x5 12 ^{15/16} x47 ^{1/4} x1 ^{15/16} Pcs. Box 1 - LM x Box 1,20	-	DX E9FG	-	-	-	-	● 1011
		-	SX E9FH	-	-	-	-	
	Nat. Rett. 33x120x2,5 12 ^{15/16} x47 ^{1/4} x1 ^{15/16} Pcs. Box 1 - LM x Box 1,20	-	E9FK	-	-	-	-	● 98
	Nat. Rett. 33x120x2,5 12 ^{15/16} x47 ^{1/4} x1 ^{15/16} Pcs. Box 1 - LM x Box 1,20	-	DX E9FL	-	-	-	-	● 1011
		-	SX E9FM	-	-	-	-	
	Nat. Rett. 33x120 - 12 ^{15/16} x47 ^{1/4} Pcs. Box 1 - LM x Box 1,20	-	E9FN	-	-	-	-	● 97
	Nat. Rett. 16,5x120 - 6 ^{1/2} x47 ^{1/4} Pcs. Box 1 - LM x Box 1,20	-	E9FJ	-	-	-	-	● 61
	Nat. Rett. 7x60x60 2 ^{3/4} x23 ^{5/8} x23 ^{5/8} Pcs. Box 2 - LM x Box 1,20	-	DX E9FA	-	-	-	-	● 42
		-	SX E9FC	-	-	-	-	

IMBALLI E PESI

Packing and Weight | Emballages et Poids | Verpackung und Gewicht | Embalajes y Pesos | Упаковка и Вес

Formato Size Format Format Тamaño Формат cm	Spessore Thickness Epaisseur Stärke Espesor Толщина mm	Pz. x Mq. Pieces x Sqm Pcs / M ² Stk. x Qm Pzs x Mc. Шт x Кв.М.	Pz. x Scat. Pieces x Box Pcs / Bte Stk. x Krt. Pzs x Caja Шт x Кор.	Mq. x Scat. Sqm x Box M ² / Bte Qm x Krt. Mc. x Caja Кв.М. x Кор.	Peso x Scat. Weight x Box Poids / Bte Gewicht x Krt. Peso x Caja Вес x Кор.	Scat. x Pal. Boxes x Pal. Bte / Pal. Krt. x Pal. Cajas x Pal. Кор. x Подд.	Mq. x Pal. Sqm x Pal. M ² / Pal. Qm x Pal. Mc. x Pal. Кв.М x Подд.	Peso x Pal. Weight x Pal. Poids / Pal. Gewicht x Pal. Peso x Pal. Вес x Подд. Kg
30x120 Naturale	10	2,78	4	1,440	33,89	36	51,84	1220
20x120 Naturale	10	4,17	4	0,960	22,37	40	38,40	895
15x120 Naturale	10	5,56	6	1,080	24,65	42	45,36	1035
40x120 Naturale 20MM	20	2,08	1	0,480	21,52	48	23,04	1033

MILLE remake LEGNI

TECNICA Premium Technical Feature

Nella versione Tecnica la superficie è particolarmente antiscivolo, tanto da renderla perfetta per spazi esterni, pubblici e privati.
In the Tecnica version, the surface has outstanding anti-slip properties, making it perfect for public and private outdoor areas.

FORMATI

Sizes | Formats | Formate | Tamaños | Форматы

10 mm.

25x150 - 9^{13/16}"x59^{1/6}" Naturale

20x120 - 7^{7/8}"x47^{1/4}" Naturale

20MM

40x120 - 15^{3/4}"x47^{1/4}" Naturale

SUPERFICI

Finishes | Finitions | Oberflächen
Superficies | Отделка поверхности

NATURALE

R10 DIN 51130

B (A+B) DIN 51097

Wet $\geq 0,50$ ANSI A 137.1- 2012 DCOF (Section 9.6)

$\geq 0,40$ B.C.R.A.

P2 AS 4586: 2013

< 36 Moderate Slip potential BS 7976-2: 2002

- ENV 12633-2006

TECNICA | 20MM

R11 DIN 51130

C (A+B+C) DIN 51097

Wet $\geq 0,65$ ANSI A 137.1- 2012 DCOF (Section 9.6)

$\geq 0,40$ B.C.R.A.

P4 AS 4586: 2013

> 36 Low Slip potential BS 7976-2: 2002

3 ENV 12633-2006

SHADE VARIATIONS



V3 HIGH

DESTINAZIONI D'USO

Intended uses | Domaines d'application
Zweckbestimmung | Usos previstos | Назначение



Ceramics of Italy

放射性水平分類

Min. 7,5%



008 OLMO SBIANCATO



009 OLMO NATURALE



010 OLMO DORATO



011 OLMO TINTO

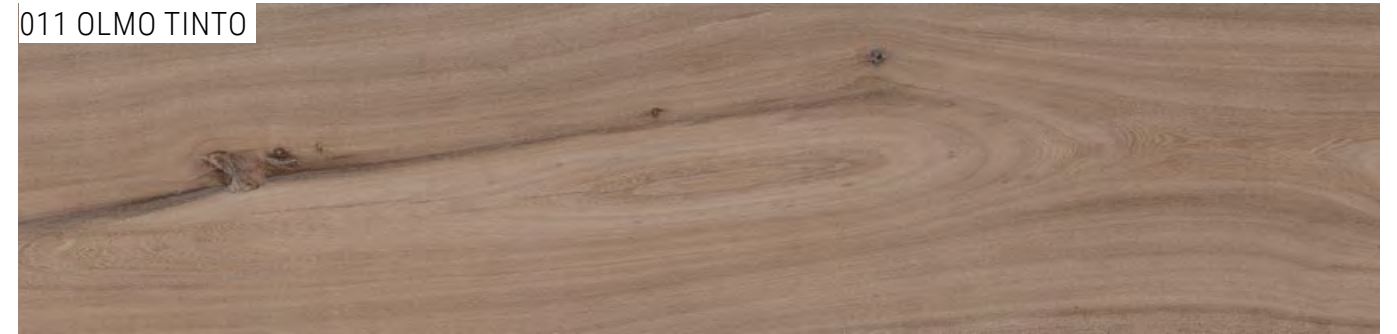

012 ROVERE OSSIDATO

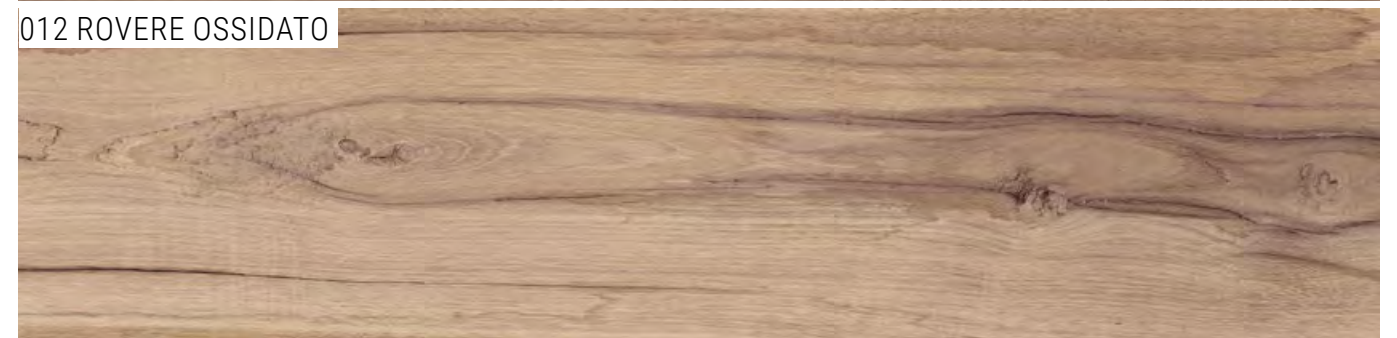

013 ROVERE BRUNO OSSIDATO

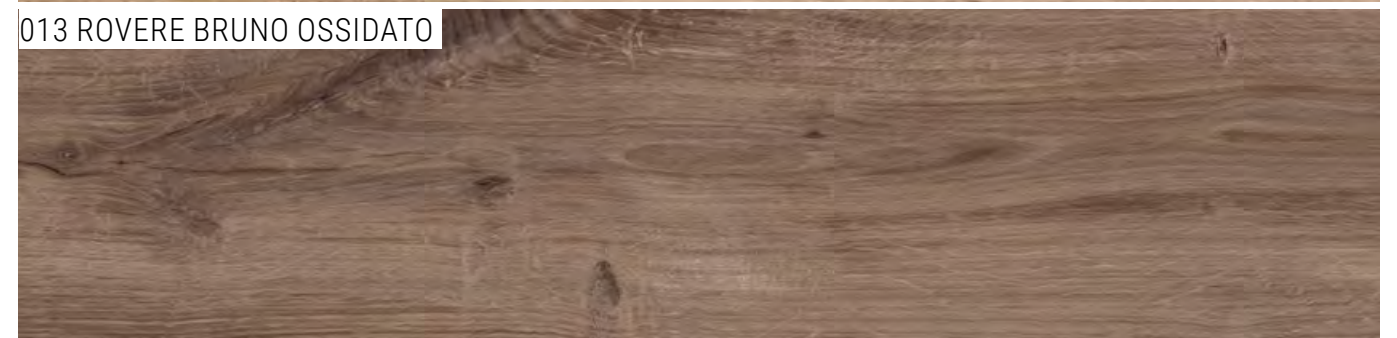

MILLELEGGNI REMAKE

COLORI E FORMATI

Colours and Sizes | Couleurs et Formats | Farben und Formate | Colores y Tamaños | Цвета и Форматы

008 Olmo Sbiancato



009 Olmo Naturale



010 Olmo Dorato



011 Olmo Tinto

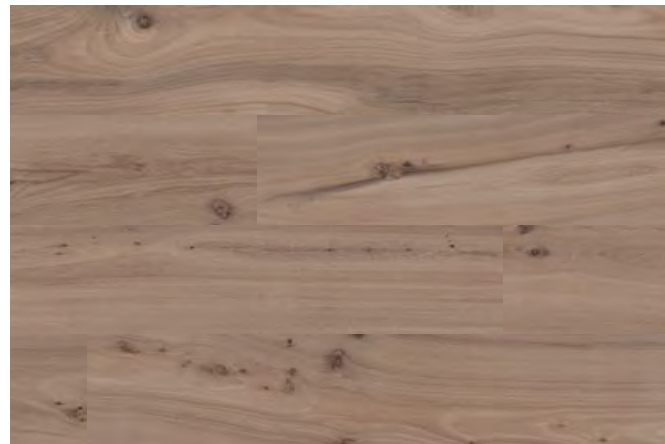

012 Rovere Ossidato

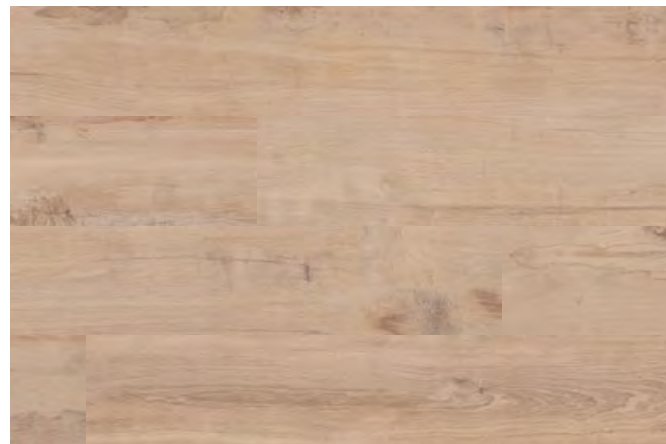

013 Rovere Bruno Ossidato

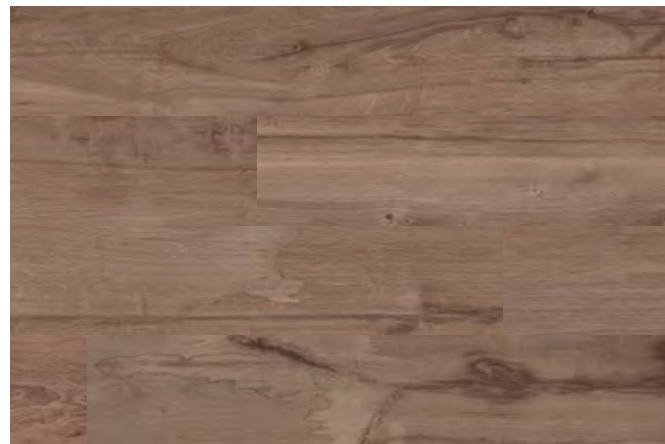

MILLELEGGNI REMAKE

COLORI E FORMATI

Colours and Sizes | Couleurs et Formats | Farben und Formate | Colores y Tamaños | Цвета и Форматы

10 mm.



Naturale Rett.

25x150 - 9^{13/16}"x59^{1/6}"

- EH2G 008 Olmo Sbiancato ● 82
- EH2H 009 Olmo Naturale ● 82
- EH5R 010 Olmo Dorato ● 82
- EH2J 011 Olmo Tinto ● 82
- EH2K 012 Rovere Ossidato ● 82
- EH2L 013 Rovere Bruno Ossidato ● 82



Naturale Rett.

20x120 - 7^{7/8}"x47^{1/4}"

- EH2N 008 Olmo Sbiancato ● 79
- EH2P 009 Olmo Naturale ● 79
- EH5T 010 Olmo Dorato ● 79
- EH2R 011 Olmo Tinto ● 79
- EH2S 012 Rovere Ossidato ● 79
- EH2T 013 Rovere Bruno Ossidato ● 79

Tecnica Rett.

20x120 - 7^{7/8}"x47^{1/4}"

- EHV3 009 Olmo Naturale ● 79
- EHV4 012 Rovere Ossidato ● 79

20MM

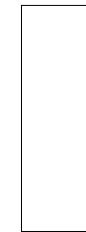

Naturale Rett.

40x120 - 15^{3/4}"x47^{1/4}"









- EH67 011 Olmo Tinto ● 89
- EH68 012 Rovere Ossidato ● 89

Si consiglia la posa con fuga 2 mm. - Laying with a 2 mm-joint is recommended. - Pose recommandée avec joints de 2 mm.
Es wird eine Fugenbreite von 2 mm empfohlen. - Se recomienda la colocación con juntas de 2 mm. - Рекомендуется укладка с швом 2 мм.

MILLELEGGNI REMAKE

PEZZI SPECIALI

Trims | Pieces Speciales | Formteile | Piezas Especiales | Специальные Изделия

	Dimensione Size							Fascia di prezzo Price band
 Battiscopa - Skirting	Nat. Rett. 4,6x120 - 1 ¹³ / ₁₆ x47 ¹ / ₄ " Pcs. Box 6 - LM x Box 7,20	EH2V	EH2W	EHKZ	EH2X	EH2Y	EH2Z	● 39
 Gradone - Step	Nat. Rett. 33x120x3,2x3,2 12 ¹⁵ / ₁₆ x47 ¹ / ₄ x1 ¹ / ₄ x1 ¹ / ₄ " Pcs. Box. 2 - LM x Box 2,40	EH31	EH32	EHL1	EH33	EH34	EH35	● 95
 Angolare Dx Sx Corner Tile Dx Sx	Nat. Rett. 33x120x3,2x3,2 12 ¹⁵ / ₁₆ x47 ¹ / ₄ x1 ¹ / ₄ x1 ¹ / ₄ " Pcs. Box. 1 - LM x Box 1,20	DX EH3L	DX EH3M	DX EHL7	DX EH3N	DX EH3P	DX EH3Q	● 100
		SX EH3S	SX EH3T	SX EHL9	SX EH3U	SX EH3V	SX EH3W	

Pezzi speciali 20mm su richiesta.
20mm trims available on request.
Pièces spéciales 20mm (sur demande).
Formteile 20mm auf anfrage erhältlich.
Piezas especiales 20mm disponibles bajo pedido.
Специальные изделия 20мм по запросу.

IMBALLI E PESI

Packing and Weight | Emballages et Poids | Verpackung und Gewicht | Embalajes y Pesos | Упаковка и Вес

Formato Size Format Format Татаño Формат cm	Spessore Thickness Epaisseur Stärke Espesor Толщина mm	Pz. x Mq. Pieces x Sqm Pcs / M ² Stk. x Qm Pzs x Mc. Шт x Кв.М.	Pz. x Scat. Pieces x Box Pcs / Bte Stk. x Krt. Pzs x Caja Шт x Кор.	Mq. x Scat. Sqm x Box M ² / Bte Qm x Krt. Mc. x Caja Кв.М. x Кор.	Peso x Scat. Weight x Box Poids / Bte Gewicht x Krt. Вес x Кор. Kg	Scat. x Pal. Boxes x Pal. Bte / Pal. Krt. x Pal. Cajas x Pal. Кор. x Подд.	Mq. x Pal. Sqm x Pal. M ² / Pal. Qm x Pal. Mc. x Pal. Кв.М x Подд.	Peso x Pal. Weight x Pal. Poids / Pal. Gewicht x Pal. Peso x Pal. Вес x Подд. Kg
25x150 Naturale	10	2,67	3	1,125	25,37	45	50,63	1142
20x120 Naturale - Tecnica	10	4,17	4	0,960	22,24	40	38,40	890
40x120 Naturale 20MM	20	2,08	1	0,480	21,69	48	23,04	1041

MILLELEGGNI REMAKE



Olmo Naturale Nat. Rett.
20x120 - 7⁷/₁₆x47¹/₄"

Olmo Tinto Nat. Rett.
25x150 - 9¹³/₁₆x59¹/₆"

NORDIKA

FORMATI

Sizes | Formats | Formate | Tamaños | Форматы

 10 mm.

60x120 - 23^{5/8}"x47^{1/4}" Naturale

90x90 - 35^{7/16}"x35^{7/16}" Naturale

45x90 - 17^{11/16}"x35^{7/16}" Naturale

60x60 - 23^{5/8}"x23^{5/8}" Naturale

30x60 - 11^{13/16}"x23^{5/8}" Naturale

20MM

50x100 - 19^{11/16}"x39^{3/8}" Naturale

SUPERFICI

Finishes | Finitions | Oberflächen
Superficies | Отделка поверхности

NATURALE

R10 DIN 51130

B (A+B) DIN 51097

Wet $\geq 0,50$ ANSI A 137.1- 2012 DCOF (Section 9.6)

$\geq 0,40$ B.C.R.A.

P3 AS 4586: 2013

< 36 Moderate Slip potential BS 7976-2: 2002

- ENV 12633-2006

20MM

R11 DIN 51130

C (A+B+C) DIN 51097

Wet $\geq 0,65$ ANSI A 137.1- 2012 DCOF (Section 9.6)

$\geq 0,40$ B.C.R.A.

P4 AS 4586: 2013

> 36 Low Slip potential BS 7976-2: 2002

3 ENV 12633-2006

SHADE VARIATIONS



V3 HIGH

DESTINAZIONI D'USO

Intended uses | Domaines d'application
Zweckbestimmung | Usos previstos | Назначение



Min. 7,5%



SAND



GREY



DARK



NORDIKA

COLORI E FORMATI

Colours and Sizes | Couleurs et Formats | Farben und Formate | Colores y Tamaños | Цвета и Форматы

Sand



Grey



Dark



NORDIKA

COLORI E FORMATI

Colours and Sizes | Couleurs et Formats | Farben und Formate | Colores y Tamaños | Цвета и Форматы

10 mm.

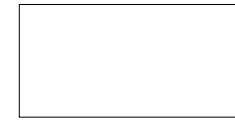

Naturale Rett.

60x120 - 23^{5/8}"x47^{1/4}"

- ECUU Sand 771
- ECUV Grey 771
- ECUW Dark 771



Naturale Rett.

90x90 - 35^{7/16}"x35^{7/16}"

- ECUG Sand 80
- ECUH Grey 80
- ECUJ Dark 80



Naturale Rett.

45x90 - 17^{11/16}"x35^{7/16}"

- ECUR Sand 73
- ECUS Grey 73
- ECUT Dark 73

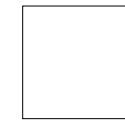

Naturale Rett.

60x60 - 23^{5/8}"x23^{5/8}"

- ECUK Sand 662
- ECUL Grey 662
- ECUM Dark 662



Naturale Rett.

30x60 - 11^{13/16}"x23^{5/8}"

- ECUN Sand 61
- ECUP Grey 61
- ECUQ Dark 61

20MM

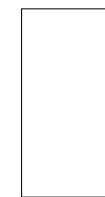

Naturale Rett.

50x100 - 19^{11/16}"x39^{3/8}"

- ECWR Sand 85
- ECWS Grey 85
- ECWT Dark 85

Si consiglia la posa con fuga 2 mm. - Laying with a 2 mm-joint is recommended. - Pose recommandée avec joints de 2 mm.
Es wird eine Fugenbreite von 2 mm empfohlen. - Se recomienda la colocación con juntas de 2 mm. - Рекомендуется укладка с швом 2 мм.

NORDIKA

DECORI

Decors | Decors | Dekore | Decorados | Декоры

MOSAICO 3X3*

Tessera - Chip 2,8x2,8 - 1^{1/8}"x1^{1/8}"



30x30 - 11^{13/16}"x11^{13/16}"
ECWK Sand Nat. ● 98

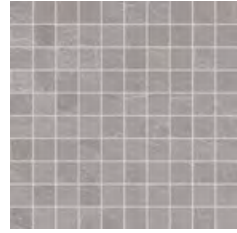

30x30 - 11^{13/16}"x11^{13/16}"
ECWL Grey Nat. ● 98

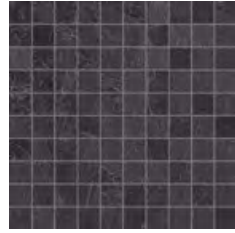

30x30 - 11^{13/16}"x11^{13/16}"
ECWM Dark Nat. ● 98

MOSAICO 10X10*

Tessera - Chip 9,8x9,8 - 3^{7/8}"x 3^{7/8}"

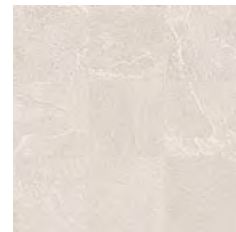

30x30 - 11^{13/16}"x11^{13/16}"
ECWN Sand Nat. ● 90



30x30 - 11^{13/16}"x11^{13/16}"
ECWP Grey Nat. ● 90



30x30 - 11^{13/16}"x11^{13/16}"
ECWQ Dark Nat. ● 90

* Su rete in fibra - On fibre mesh backing - Sur filet en fibre de verre - Auf Glasfasernetz - Sobre malla de fibra - На волоконной сетке

IMBALLI E PESI

Packing and Weight | Emballages et Poids | Verpackung und Gewicht | Embalajes y Pesos | Упаковка и Вес

Formato Size Format Tamaño Формат cm	Spessore Thickness Epaisseur Stärke Espesor Толщина mm	Pz. x Mq. Pieces x Sqm Pcs / M ² Stk. x Qm Pzs x Mc. Шт x Кв.М.	Pz. x Scat. Pieces x Box Pcs / Bte Stk. x Krt. Pzs x Caja Шт x Кор.	Mq. x Scat. Sqm x Box M ² / Bte Qm x Krt. Mc. x Caja Кв.М. x Кор.	Peso x Scat. Weight x Box Poids / Bte Gewicht x Krt. Peso x Caja Вес x Кор. Kg	Scat. x Pal. Boxes x Pal. Bte / Pal. Krt. x Pal. Cajas x Pal. Кор. x Подд.	Mq. x Pal. Sqm x Pal. M ² / Pal. Qm x Pal. Mc. x Pal. Кв.М x Подд.	Peso x Pal. Weight x Pal. Poids / Pal. Gewicht x Pal. Peso x Pal. Вес x Подд. Kg
60x120 Naturale	10	1,39	2	1,440	32,69	36	51,84	1177
90x90 Naturale	10	1,23	2	1,620	37,19	24	38,88	893
45x90 Naturale	10	2,47	3	1,215	27,96	32	38,88	895
60x60 Naturale	10	2,78	3	1,080	23,8	40	43,20	952
30x60 Naturale	10	5,56	6	1,080	23,84	40	43,20	954
50x100 Naturale 20MM	20	2,00	1	0,500	22,75	50	25,00	1138
30x30 Mosaico 3X3	10	11,11	5	0,450	10,50	60	27,00	630
30x30 Mosaico 10X10	10	11,11	5	0,450	10,50	60	27,00	630

NORDIKA

PEZZI SPECIALI

Trims | Pieces Speciales | Formteile | Piezas Especiales | Специальные Изделия

	Dimensione Size				Fascia di prezzo Price band			
 Battiscopa - Skirting	Nat. Rett. 7x60 - 2 ^{3/4} "x23 ^{5/8} " Pcs. Box 14 - LM x Box 8,40	ECWU	ECWV	ECWW	● 11			
 Gradino - Stair Tread	Nat. Rett. 4,6x90 - 1 ^{13/16} "x35 ^{7/16} " Pcs. Box 8 - LM x Box 7,20	ECWD	ECWE	ECWF	● 17			
 Gradone - Step	Nat. Rett. 33x120 - 12 ^{15/16} "x47 ^{1/4} " Pcs. Box 2 - LM x Box 2,40	ED8U	ED8V	ED8W	● 91			
 Angolare Dx Sx Corner Tile Dx Sx	Nat. Rett. 33x120x3,2x3,2 12 ^{15/16} "x47 ^{1/4} "x1 ^{1/4} "x1 ^{1/4} " Pcs. Box 2 - LM x Box 2,40	ECWG	ECWH	ECWJ	● 95			
	Nat. Rett. 33x120x3,2x3,2 12 ^{15/16} "x47 ^{1/4} "x1 ^{1/4} "x1 ^{1/4} " Pcs. Box 1 - LM x Box 1,20	DX ECW6	SX ECW7	DX ECW8	SX ECW9	DX ECWA	SX ECWC	● 100

20MM PEZZI SPECIALI

Trims | Pieces Speciales | Formteile | Piezas Especiales | Специальные Изделия

	Dimensione Size				Fascia di prezzo Price band			
 Gradone - Step	Nat. Rett. 33x100x5 12 ^{15/16} "x39 ^{3/8} "x1 ^{15/16} " Pcs. Box 2 - LM x Box 2,00	ED18	ED1C	ED1F	● 93			
 Angolare Dx Sx Corner Tile Dx Sx	Nat. Rett. 33x100x5 12 ^{15/16} "x39 ^{3/8} "x1 ^{15/16} " Pcs. Box 2 - LM x Box 2,00	DX ED19	SX ED1A	DX ED1D	SX ED1E	DX ED1G	SX ED1H	● 98
 Terminale - Endingpiece	Nat. Rett. 33x100x2,5 12 ^{15/16} "x39 ^{3/8} "x1 ^{15/16} " Pcs. Box 2 - LM x Box 2,00	ED0Z	ED12	ED15	● 93			
 Ang. Terminale Dx Sx Endingpiece Corner Dx Sx	Nat. Rett. 33x100x2,5 12 ^{15/16} "x39 ^{3/8} "x1 ^{15/16} " Pcs. Box 2 - LM x Box 2,00	DX ED10	SX ED11	DX ED13	SX ED14	DX ED16	SX ED17	● 98
 Gradino - Stair Tread	Nat. Rett. 33x100 - 12 ^{15/16} "x39 ^{3/8} " Pcs. Box 2 - LM x Box 2,00	ED0W	ED0X	ED0Y	● 91			
 Alzata - Riser	Nat. Rett. 16,5x100 - 6 ^{1/2} "x39 ^{3/8} " Pcs. Box 4 - LM x Box 4,00	ED0T	ED0U	ED0V	● 54			

On Square

FORMATI

Sizes | Formats | Formate | Tamaños | Форматы

 10 mm.

60x120 - 23^{5/8}"x47^{1/4}" Naturale - Lappato

80x80 - 31^{1/2}"x31^{1/2}" Naturale - Lappato

45x90 - 17^{11/16}"x35^{7/16}" Naturale - Lappato

60x60 - 23^{5/8}"x23^{5/8}" Naturale - Lappato

30x60 - 11^{13/16}"x23^{5/8}" Naturale - Lappato

20MM

45x90 - 17^{11/16}"x35^{7/16}" Naturale

60x60 - 23^{5/8}"x23^{5/8}" Naturale

SUPERFICI

Finishes | Finitions | Oberflächen
Superficies | Отделка поверхности

NATURALE

R10 DIN 51130

B (A+B) DIN 51097

Wet \geq 0,42 ANSI A 137.1- 2012 DCOF (Section 9.6)

\geq 0,40 B.C.R.A.

- AS 4586: 2013

< 36 Moderate Slip potential BS 7976-2: 2002

2 ENV 12633-2006

LAPPATO

R9 DIN 51130

- DIN 51097

Wet \geq 0,42 ANSI A 137.1- 2012 DCOF (Section 9.6)

\geq 0,40 B.C.R.A.

- AS 4586: 2013

- BS 7976-2: 2002

- ENV 12633-2006

20MM

R11 DIN 51130

C (A+B+C) DIN 51097

Wet \geq 0,65 ANSI A 137.1- 2012 DCOF (Section 9.6)

\geq 0,40 B.C.R.A.

P4 AS 4586: 2013

> 36 Low Slip potential BS 7976-2: 2002

3 ENV 12633-2006

SHADE VARIATIONS



V3 HIGH

DESTINAZIONI D'USO

Intended uses | Domaines d'application
Zweckbestimmung | Usos previstos | Назначение

NATURALE - 20MM



LAPPATO



Ceramics of Italy 放射性水平A类 Min. 7.5%



AVORIO



SABBIA

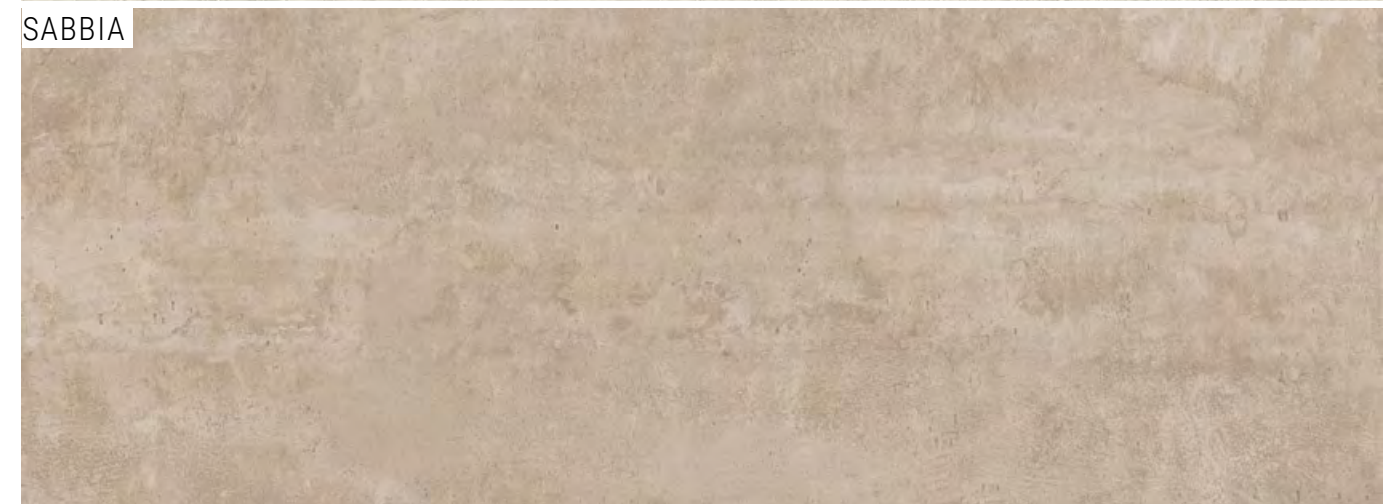

CEMENTO



LAVAGNA



ON SQUARE

COLORI E FORMATI

Colours and Sizes | Couleurs et Formats | Farben und Formate | Colores y Tamaños | Цвета и Форматы

Avorio



Sabbia



Cemento



Lavagna



ON SQUARE

COLORI E FORMATI

Colours and Sizes | Couleurs et Formats | Farben und Formate | Colores y Tamaños | Цвета и Форматы

10 mm.



Naturale Rett.
60x120 - 23^{5/8}"x47^{1/4}"
E78J Avorio ● 771
E78K Sabbia ● 771
E78L Cemento ● 771
E78M Lavagna ● 771

Lappato Rett.
60x120 - 23^{5/8}"x47^{1/4}"
E7HH Avorio ● 80
E7HJ Sabbia ● 80
E7GN Cemento ● 80
E7HK Lavagna ● 80



Naturale Rett.
45x90 - 17^{11/16}"x35^{7/16}"
E2LA Avorio ● 73
E2LD Sabbia ● 73
E2LF Cemento ● 73
E2LH Lavagna ● 73

Lappato Rett.
45x90 - 17^{11/16}"x35^{7/16}"
E2L9 Avorio ● 81
E2LC Sabbia ● 81
E2LE Cemento ● 81
E2LG Lavagna ● 81



Naturale Rett.
80x80 - 31^{1/2}"x31^{1/2}"
E1NS Avorio ● 78
E1NU Sabbia ● 78
E1NW Cemento ● 78
E1NY Lavagna ● 78

Lappato Rett.
80x80 - 31^{1/2}"x31^{1/2}"
E1NR Avorio ● 81
E1NT Sabbia ● 81
E1NV Cemento ● 81
E1NX Lavagna ● 81



Naturale Rett.
60x60 - 23^{5/8}"x23^{5/8}"
E1N9 Avorio ● 662
E1NC Sabbia ● 662
E1NE Cemento ● 662
E1NG Lavagna ● 662

Lappato Rett.
60x60 - 23^{5/8}"x23^{5/8}"
E1N8 Avorio ● 771
E1NA Sabbia ● 771
E1ND Cemento ● 771
E1NF Lavagna ● 771



Naturale Rett.
30x60 - 11^{13/16}"x23^{5/8}"
E1NJ Avorio ● 61
E1NL Sabbia ● 61
E1NN Cemento ● 61
E1NQ Lavagna ● 61

Lappato Rett.
30x60 - 11^{13/16}"x23^{5/8}"
E1NH Avorio ● 73
E1NK Sabbia ● 73
E1NM Cemento ● 73
E1NP Lavagna ● 73

20MM

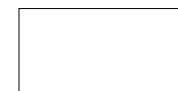

Naturale Rett.
45x90 - 17^{11/16}"x35^{7/16}"
E7TU Avorio ● 84
E7TW Cemento ● 84

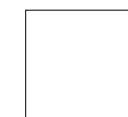

Naturale Rett.
60x60 - 23^{5/8}"x23^{5/8}"
E2PE Avorio ● 83
E2PF Sabbia ● 83
E2PG Cemento ● 83
E37L Lavagna ● 83

Si consiglia la posa con fuga 2 mm. - Laying with a 2 mm-joint is recommended. - Pose recommandée avec joints de 2 mm.
Es wird eine Fugenbreite von 2 mm empfohlen. - Se recomienda la colocación con juntas de 2 mm. - Рекомендуются укладка с швом 2 мм.

ON SQUARE

DECORI

Decors | Decors | Dekore | Decorados | Декоры

ON SQUARE DECOR

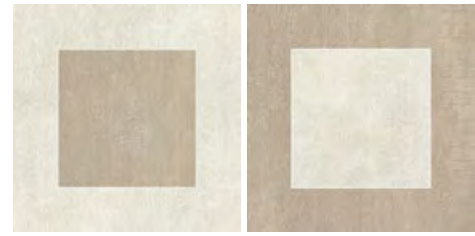

30x30 - 11^{13/16}"x11^{13/16}"
E1N6 Avorio/Sabbia Nat. Rett.
 Pcs. Box 4

● 25

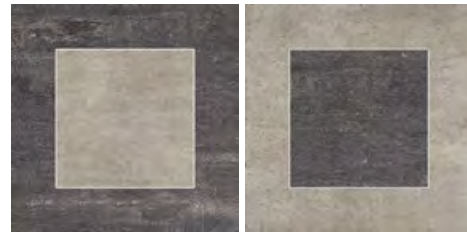

30x30 - 11^{13/16}"x11^{13/16}"
E1N7 Cemento/Lavagna Nat. Rett.
 Pcs. Box 4

● 25

MOSAICO*

Tessera - Chip 4,8x4,8 - 1^{7/8}"x1^{7/8}"



30x30 - 11^{13/16}"x11^{13/16}"
E2Y9 Avorio Nat. ● 92

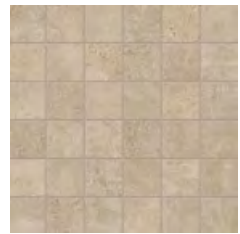

30x30 - 11^{13/16}"x11^{13/16}"
E2YA Sabbia Nat. ● 92



30x30 - 11^{13/16}"x11^{13/16}"
E2YC Cemento Nat. ● 92



30x30 - 11^{13/16}"x11^{13/16}"
E2YD Lavagna Nat. ● 92

LISTELLI SFALSATI*

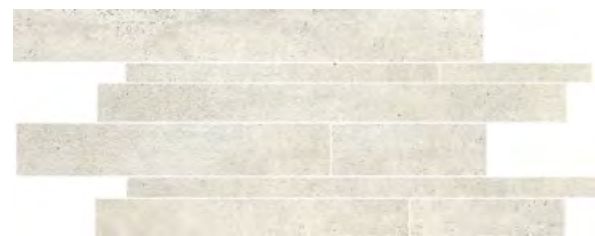

30x60 - 11^{13/16}"x23^{5/8}"
E1N2 Avorio Nat. ● 87

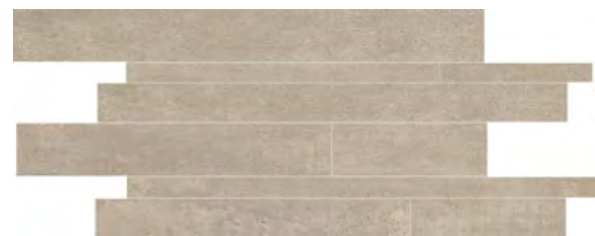

30x60 - 11^{13/16}"x23^{5/8}"
E1N3 Sabbia Nat. ● 87



30x60 - 11^{13/16}"x23^{5/8}"
E1N4 Cemento Nat. ● 87

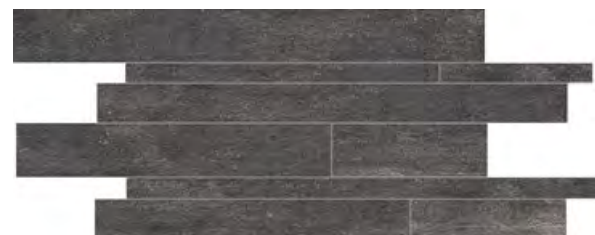

30x60 - 11^{13/16}"x23^{5/8}"
E1N5 Lavagna Nat. ● 87

* Su rete in fibra - On fibre mesh backing - Sur filet en fibre de verre - Auf Glasfasernetz - Sobre malla de fibra - На волоконной сетке

ON SQUARE

PEZZI SPECIALI

Trims | Pieces Speciales | Formteile | Piezas Especiales | Специальные Изделия

	Dimensione Size	Avorio	Sabbia	Cemento	Lavagna	Fascia di prezzo Price band				
Battiscopa - Skirting	Nat. Rett. 7x60 - 2 ^{3/4} "x23 ^{5/8} " Pcs. Box 14 - LM x Box 8,40	E1QM	E1QN	E1QP	E1QQ	● 11				
Gradone - Step	Nat. Rett. 33x60x3,2x3,2 12 ^{15/16} "x47 ^{1/4} "x1 ^{1/4} "x1 ^{1/4} " Pcs. Box 4 - LM x Box 2,40	E2DP	E8L7	E8L8	E2DQ	● 661				
	Nat. Rett. 33x120x3,2x3,2 12 ^{15/16} "x47 ^{1/4} "x1 ^{1/4} "x1 ^{1/4} " Pcs. Box 2 - LM x Box 2,40	E8T8	E8CZ	E8TC	E8TE	● 95				
Angolare Dx Sx Corner Tile Dx Sx	Lapp. Rett. 33x120x3,2x3,2 12 ^{15/16} "x47 ^{1/4} "x1 ^{1/4} "x1 ^{1/4} " Pcs. Box 2 - LM x Box 2,40	E8T7	E8T9	E8TA	E8TD	● 99				
	Nat. Rett. 33x120x3,2x3,2 12 ^{15/16} "x47 ^{1/4} "x1 ^{1/4} "x1 ^{1/4} " Pcs. Box 1 - LM x Box 1,20	DX E8SG	SX E8SH	DX E8SL	SX E8SM	DX E8SQ	SX E8SR	DX E8SU	SX E8SV	● 100
Angolare Corner Tile	Lapp. Rett. 33x120x3,2x3,2 12 ^{15/16} "x47 ^{1/4} "x1 ^{1/4} "x1 ^{1/4} " Pcs. Box 1 - LM x Box 1,20	DX E8SE	SX E8SF	DX E8SJ	SX E8SK	DX E8SN	SX E8SP	DX E8SS	SX E8ST	● 101
	Nat. Rett. 33x33x3,2x3,2 12 ^{15/16} "x12 ^{15/16} "x1 ^{1/4} "x1 ^{1/4} " Pcs. Box 2 - LM x Box 0,66	E8L6	E8LE	E8LF	E8LG					● 100
Battiscopa Scala Dx Sx Tread Skirting Dx Sx	Nat. Rett. 7x60x60 2 ^{3/4} "x23 ^{5/8} "x23 ^{5/8} " Pcs. Box 2 - LM x Box 1,20	DX E2W1	SX E954	DX E955	SX E956	DX E957	SX E958	DX E32X	SX E9F0	● 42
Battiscopa Scala Dx Sx Tread Skirting Dx Sx	Nat. Rett. 7x60x60 2 ^{3/4} "x23 ^{5/8} "x23 ^{5/8} " Pcs. Box 2 - LM x Box 1,20	DX E959	SX E95A	DX E95C	SX E95D	DX E95E	SX E95F	DX E9F1	SX E9F2	● 42

IMBALLI E PESI

Packing and Weight | Emballages et Poids | Verpackung und Gewicht | Embalajes y Pesos | Упаковка и Вес

Formato Size Format Format Tamaño Формат cm	Spessore Thickness Epaisseur Stärke Espesor Толщина mm	Pz. x Mq. Pieces x Sqm Pcs / M ² Stk. x Qm Pzs x Mc. Шт x Кв.М.	Pz. x Scat. Pieces x Box Pcs / Bte Stk. x Krt. Pzs x Caja Шт x Кор.	Mq. x Scat. Sqm x Box M ² / Bte Qm x Krt. Mc. x Caja Кв.М. x Кор.	Peso x Scat. Weight x Box Poids / Bte Gewicht x Krt. Peso x Caja Вес x Кор. Kg	Scat. x Pal. Boxes x Pal. Bte / Pal. Krt. x Pal. Cajas x Pal. Кор. x Подд.	Mq. x Pal. Sqm x Pal. M ² / Pal. Qm x Pal. Mc. x Pal. Кв.М x Подд.	Peso x Pal. Weight x Pal. Poids / Pal. Gewicht x Pal. Peso x Pal. Вес x Подд. Kg
60x120 Naturale - Lappato	10	1,39	2	1,440	32,71	36	51,84	1178
45x90 Naturale - Lappato	10	2,47	3	1,215	27,39	32	38,88	876
45x90 Naturale 20MM	20	2,47	2	0,810	35,34	24	18,44	848
80x80 Naturale - Lappato	10	1,56	2	1,280	29,86	42	53,76	1254
60x60 Naturale	10	2,78	3	1,080	23,78	40	43,20	951
60x60 Naturale 20MM	20	2,78	2	0,720	32,68	32	23,04	1046
30x60 Naturale	10	5,56	6	1,080	23,54	40	43,20	942
30x60 Listelli sfalsati	10	5,56	4	0,720	16	30	21,60	480
30x30 Mosaico	10	11,11	5	0,450	10,00	60	27,00	600

20MM PEZZI SPECIALI

Trims | Pieces Speciales | Formteile | Piezas Especiales | Специальные Изделия

	Dimensione Size	 Avorio	 Sabbia	 Cemento	 Lavagna	Fascia di prezzo Price band				
	Nat. Rett. 33x60x5 12 ^{15/16} "x23 ^{5/8} "x1 ^{15/16} " Pcs. Box 2 - LM x Box 1,20	E95R	E95U	E2W9	E9F3	● 83				
	Nat. Rett. 33x90x5 12 ^{15/16} "x35 ^{7/16} "x1 ^{15/16} " Pcs. Box 2 - LM x Box 1,80	E9U1	-	E9U7	-	● 90				
	Nat. Rett. 33x60x5 12 ^{15/16} "x23 ^{5/8} "x1 ^{15/16} " Pcs. Box 2 - LM x Box 1,20	DX E95S	SX E95T	DX E95V	SX E95W	DX E95X	SX E95Y	DX E9F4	SX E9F5	● 93
	Nat. Rett. 33x90x5 12 ^{15/16} "x35 ^{7/16} "x1 ^{15/16} " Pcs. Box 2 - LM x Box 1,80	DX E9U2	SX E9U3	-	-	DX E9U8	SX E9U9	-	-	● 97
	Nat. Rett. 33x60x2,5 12 ^{15/16} "x23 ^{5/8} "x1 ^{15/16} " Pcs. Box 2 - LM x Box 1,20	E968	E96C	E2WA	E9F6	● 83				
	Nat. Rett. 33x90x2,5 12 ^{15/16} "x35 ^{7/16} "x1 ^{15/16} " Pcs. Box 2 - LM x Box 1,80	E9US	-	E9UY	-	● 90				
	Nat. Rett. 33x60x2,5 12 ^{15/16} "x23 ^{5/8} "x1 ^{15/16} " Pcs. Box 2 - LM x Box 1,20	DX E969	SX E96A	DX E96D	SX E96E	DX E96F	SX E96G	DX E9F7	SX E9F8	● 93
	Nat. Rett. 33x90x2,5 12 ^{15/16} "x35 ^{7/16} "x1 ^{15/16} " Pcs. Box 2 - LM x Box 1,80	DX E9UT	SX E9UU	-	-	DX E9UZ	SX E9V0	-	-	● 97
	Nat. Rett. 33x60 - 12 ^{15/16} "x23 ^{5/8} " Pcs. Box 2 - LM x Box 1,20	E96H	E96J	E2WC	E9F9	● 77				
	Nat. Rett. 33x90 - 12 ^{15/16} "x35 ^{7/16} " Pcs. Box 2 - LM x Box 1,80	E9VH	-	E9VK	-	● 88				
	Nat. Rett. 16,5x60 - 6 ^{1/2} "x23 ^{5/8} " Pcs. Box 2 - LM x Box 1,20	E2W6	E2W7	E2W8	E37M	● 40				
	Nat. Rett. 16,5x90 - 6 ^{1/2} "x35 ^{7/16} " Pcs. Box 4 - LM x Box 3,60	E9TT	-	E9TV	-	● 53				
	10 mm. Nat. Rett. 7x60x60 2 ^{3/4} "x23 ^{5/8} "x23 ^{5/8} " Pcs. Box 2 - LM x Box 1,20	DX E2W1	SX E954	DX E955	SX E956	DX E957	SX E958	DX E32X	SX E9F0	● 42



Lavagna Naturale
60x60 - 23^{5/8}"x23^{5/8}"

Sabbia Naturale
30x60 - 11^{13/16}"x23^{5/8}"

On Square Decor Avorio/Sabbia
30x30 - 11^{13/16}"x11^{13/16}"

Petra

FORMATI

Sizes | Formats | Formate | Tamaños | Форматы

 10 mm.

80x80 - 31^{1/2}"x31^{1/2}" Naturale - Lappato

20x80 - 7^{7/8}"x31^{1/2}" Naturale - Lappato

60x60 - 23^{5/8}"x23^{5/8}" Naturale - Lappato

30x60 - 11^{13/16}"x23^{5/8}" Naturale

SUPERFICI

Finishes | Finitions | Oberflächen
Superficies | Отделка поверхности

NATURALE

R10 DIN 51130

B (A+B) DIN 51097

Wet \geq 0,50 ANSI A 137.1- 2012 DCOF (Section 9.6)

\geq 0,40 B.C.R.A.

- AS 4586: 2013

< 36 Moderate Slip potential BS 7976-2: 2002

- ENV 12633-2006

LAPPATO

- DIN 51130

- DIN 51097

- ANSI A 137.1- 2012 DCOF (Section 9.6)

- B.C.R.A.

- AS 4586: 2013

- BS 7976-2: 2002

- ENV 12633-2006

SHADE VARIATIONS



V3 HIGH

DESTINAZIONI D'USO

Intended uses | Domaines d'application
Zweckbestimmung | Usos previstos | Назначение



Ceramics of Italy



放射性水平A类



Min. 7,5%



WHITE



BEIGE



GREY



PETRA

COLORI E FORMATI

Colours and Sizes | Couleurs et Formats | Farben und Formate | Colores y Tamaños | Цвета и Форматы

White



Beige



Grey



PETRA

COLORI E FORMATI

Colours and Sizes | Couleurs et Formats | Farben und Formate | Colores y Tamaños | Цвета и Форматы

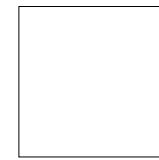

Naturale Rett.

80x80 - 31¹/₂"x31¹/₂"

E231 White ● 78
E233 Beige ● 78
E237 Grey ● 78

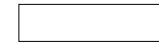

Naturale Rett.

20x80 - 7⁷/₈"x31¹/₂"

E239 White ● 88
E23C Beige ● 88
E23G Grey ● 88



Naturale Rett.

60x60 - 23⁵/₈"x23⁵/₈"

E23N White ● 662
E23Q Beige ● 662
E23U Grey ● 662



Naturale Rett.

30x60 - 11¹³/₁₆"x23⁵/₈"

E23V White ● 61
E23W Beige ● 61
E23Y Grey ● 61

Lappato Rett.

80x80 - 31¹/₂"x31¹/₂"

E230 White ● 81
E232 Beige ● 81
E236 Grey ● 81

Lappato Rett.

20x80 - 7⁷/₈"x31¹/₂"

E238 White ● 90
E23A Beige ● 90
E23F Grey ● 90

Lappato Rett.

60x60 - 23⁵/₈"x23⁵/₈"

E23M White ● 771
E23P Beige ● 771
E23T Grey ● 771

Si consiglia la posa con fuga 2 mm. - Laying with a 2 mm-joint is recommended. - Pose recommandée avec joints de 2 mm.
Es wird eine Fugenbreite von 2 mm empfohlen. - Se recomienda la colocación con juntas de 2 mm. - Рекомендуется укладка с швом 2 мм.

DECORI

Decors | Decors | Dekore | Decorados | Декоры

DECORO QUADRI



30x30 - 11¹³/₁₆"x11¹³/₁₆"

E275 White/Grey Nat. Rett.

● 25

Pcs. Box 4

PETRA

DECORI

Decors | Decors | Dekore | Decorados | Декоры

MOSAICO 5X5*

Tessera - Chip 4,8x4,8 - 1^{7/8}"x1^{7/8}"

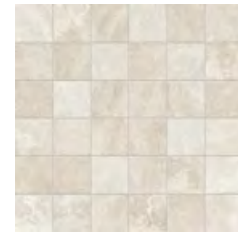

30x30 - 11^{13/16}"x11^{13/16}"
E25V White Nat. ● 93

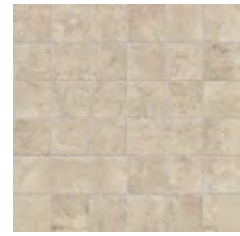

30x30 - 11^{13/16}"x11^{13/16}"
E25W Beige Nat. ● 93

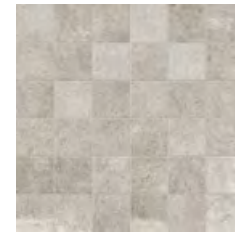

30x30 - 11^{13/16}"x11^{13/16}"
E25Y Grey Nat. ● 93

MURETTO PETRA*



30x30 - 11^{13/16}"x11^{13/16}"
E26P White Nat. ● 104



30x30 - 11^{13/16}"x11^{13/16}"
E26Q Beige Nat. ● 104



30x30 - 11^{13/16}"x11^{13/16}"
E26S Grey Nat. ● 104

LISTELLI SFALSATI*

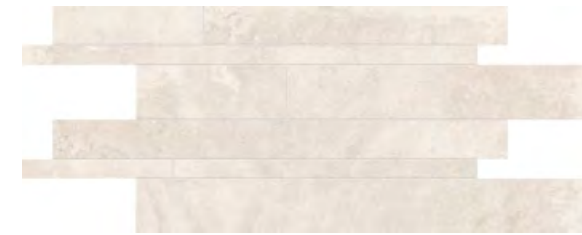

30x60 - 11^{13/16}"x23^{5/8}"
E26D White Nat. ● 87



30x60 - 11^{13/16}"x23^{5/8}"
E26E Beige Nat. ● 87

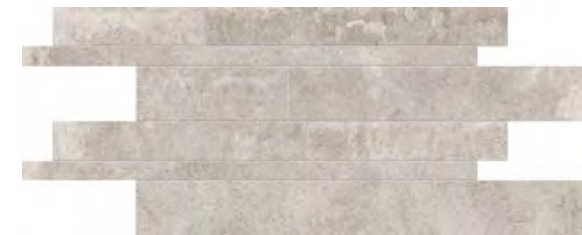

30x60 - 11^{13/16}"x23^{5/8}"
E26G Grey Nat. ● 87

* Su rete in fibra - On fibre mesh backing - Sur filet en fibre de verre - Auf Glasfasernetz - Sobre malla de fibra - На волоконной сетке

PETRA

PEZZI SPECIALI

Trims | Pieces Speciales | Formteile | Piezas Especiales | Специальные Изделия

	Dimensione Size	White	Beige	Grey	Fascia di prezzo Price band
 Battiscopa - Skirting	Nat. Rett. 7x60 - 2 ^{3/4} "x23 ^{5/8} " Pcs. Box 14 - LM x Box 8,40	E29D	E29F	E29K	● 11
	Lapp. Rett. 7x60 - 2 ^{3/4} "x23 ^{5/8} " Pcs. Box 14 - LM x Box 8,40	E29C	E29E	E29J	● 13
 Gradone - Step	Nat. Rett. 33x60x3,2x3,2 12 ^{15/16} "x23 ^{5/8} "x1 ^{1/4} "x1 ^{1/4} " Pcs. Box 4 - LM x Box 2,40	E28Z	E8FT	E8FX	● 79
	Lapp. Rett. 33x60x3,2x3,2 12 ^{15/16} "x23 ^{5/8} "x1 ^{1/4} "x1 ^{1/4} " Pcs. Box 4 - LM x Box 2,40	E8FR	E8FS	E8FW	● 81
 Angolare Dx Sx Corner Tile Dx Sx	Nat. Rett. 33x33x3,2x3,2 12 ^{15/16} "x12 ^{15/16} "x1 ^{1/4} "x1 ^{1/4} " Pcs. Box 2 - LM x Box 0,66	E290	E8G8	E8GD	● 83
	Lapp. Rett. 33x33x3,2x3,2 12 ^{15/16} "x12 ^{15/16} "x1 ^{1/4} "x1 ^{1/4} " Pcs. Box 2 - LM x Box 0,66	E8G6	E8G7	E8GC	● 85

IMBALLI E PESI

Packing and Weight | Emballages et Poids | Verpackung und Gewicht | Embalajes y Pesos | Упаковка и Вес

Formato Size Format Format Татаño Формат cm	Spessore Thickness Epaisseur Stärke Espesor Толщина mm	Pz. x Mq. Pieces x Sqm Pcs / M ² Stk. x Qm Pzs x Mc. Шт x Кв.М.	Pz. x Scat. Pieces x Box Pcs / Bte Stk. x Krt. Pzs x Caja Шт x Кор.	Mq. x Scat. Sqm x Box M ² / Bte Qm x Krt. Mc. x Caja Кв.М. x Кор.	Peso x Scat. Weight x Box Poids / Bte Gewicht x Krt. Peso x Caja Вес x Кор. Kg	Scat. x Pal. Boxes x Pal. Bte / Pal. Krt. x Pal. Cajas x Pal. Кор. x Подд.	Mq. x Pal. Sqm x Pal. M ² / Pal. Qm x Pal. Mc. x Pal. Кв.М x Подд.	Peso x Pal. Weight x Pal. Poids / Pal. Gewicht x Pal. Peso x Pal. Вес x Подд. Kg
80x80 Naturale - Lappato	10	1,56	2	1,280	30,22	42	53,76	1269
20x80 Naturale - Lappato	10	6,25	3	0,480	12	56	26,88	672
60x60 Naturale - Lappato	10	2,78	3	1,080	23,66	40	43,20	946
30x60 Naturale	10	5,56	6	1,080	23,64	40	43,20	946
30x60 Listelli Sfalsati	10	5,56	4	0,720	16,7	30	21,60	501
30x30 Mosaici - Muretto	10	11,11	5	0,450	10,50	60	27,00	630

FORMATI

Sizes | Formats | Formate | Tamaños | Форматы

9 mm.

6x25 - 2^{3/8}"x9^{13/16}" Brick Naturale

10 mm.

60x120 - 23^{5/8}"x47^{1/4}" Naturale

90x90 - 35^{7/16}"x35^{7/16}" Naturale

45x90 - 17^{11/16}"x35^{7/16}" Naturale

60x60 - 23^{5/8}"x23^{5/8}" Naturale

30x60 - 11^{13/16}"x23^{5/8}" Naturale

20MM

60x60 - 23^{5/8}"x23^{5/8}" Naturale

SUPERFICI

Finishes | Finitions | Oberflächen
Superficies | Отделка поверхности

■ NATURALE

R10 DIN 51130

B (A+B) DIN 51097

Wet \geq 0,50 ANSI A 137.1- 2012 DCOF (Section 9.6)

\geq 0,40 B.C.R.A.

P3 AS 4586: 2013

> 36 Low Slip potential BS 7976-2: 2002

2 ENV 12633:2006

■ OUTDOOR | 20MM

R11 DIN 51130

C (A+B+C) DIN 51097

Wet \geq 0,65 ANSI A 137.1- 2012 DCOF (Section 9.6)

\geq 0,40 B.C.R.A.

P3 AS 4586: 2013

> 36 Low Slip potential BS 7976-2: 2002

3 ENV 12633:2006

SHADE VARIATIONS



DESTINAZIONI D'USO

Intended uses | Domaines d'application
Zweckbestimmung | Usos previstos | Назначение



SPAZZOLATA



FIAMMATA



SPACCO MULTICOLOR



COLORI E FORMATI

Colours and Sizes | Couleurs et Formats | Farben und Formate | Colores y Tamaños | Цвета и Форматы

Spazzolata



Fiammata

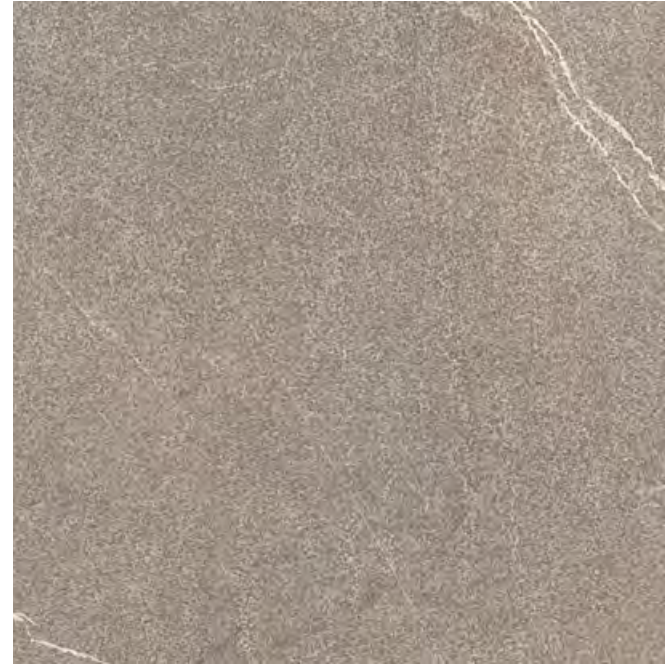

Spacco Multicolor

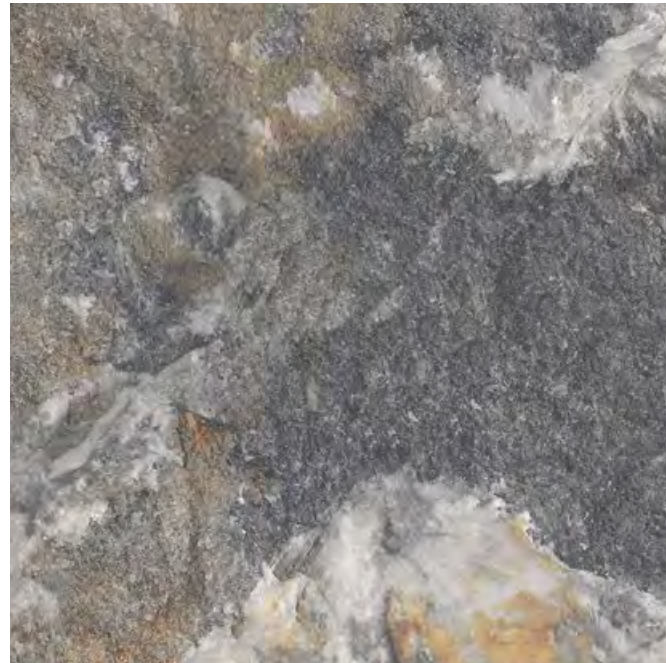

COLORI E FORMATI

Colours and Sizes | Couleurs et Formats | Farben und Formate | Colores y Tamaños | Цвета и Форматы

9 mm.



Brick Naturale

6x25 - 2^{3/8}"x9^{13/16}"

E3YX Spazzolata ● 60

E3YY Fiammata ● 60

E3YZ Spacco Multicolor ● 60

10 mm.



Naturale Rett.

60x120 - 23^{5/8}"x47^{1/4}"

E7VR Spazzolata ● 771

E7VT Fiammata ● 771

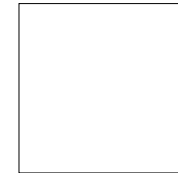

Naturale Rett.

90x90 - 35^{7/16}"x35^{7/16}"

E3YR Spazzolata ● 80

E3YT Fiammata ● 80



Naturale Rett.

45x90 - 17^{11/16}"x35^{7/16}"

E3ZP Spazzolata ● 73

E3ZR Fiammata ● 73



Naturale Rett.

60x60 - 23^{5/8}"x23^{5/8}"

E3Z8 Spazzolata ● 662

E3ZA Fiammata ● 662



Naturale Rett.

30x60 - 11^{13/16}"x23^{5/8}"

E3ZG Spazzolata ● 61

E3ZJ Fiammata ● 61

ECEQ Spacco Multicolor ● 61

20MM



Naturale Rett.

60x60 - 23^{5/8}"x23^{5/8}"

EC84 Spazzolata ● 83

E3YW Fiammata ● 83

Naturale Outdoor R11 Rett.

60x60 - 23^{5/8}"x23^{5/8}"

E485 Spazzolata ● 662

E3ZC Fiammata ● 662

Naturale Outdoor R11 Rett.

30x60 - 11^{13/16}"x23^{5/8}"

E487 Spazzolata ● 61

E3ZK Fiammata ● 61

Si consiglia la posa con fuga 2 mm. - Laying with a 2 mm-joint is recommended. - Pose recommandée avec joints de 2 mm.
Es wird eine Fugenbreite von 2 mm empfohlen. - Se recomienda la colocación con juntas de 2 mm. - Рекомендуются укладка с швом 2 мм.

DECORI

Decors | Decors | Dekore | Decorados | Декоры

DECORO ORNAMENTO



15x15 - 5⁷/₈"x5⁷/₈"
E45M Spazzolata Nat. Rett. ● 85



15x15 - 5⁷/₈"x5⁷/₈"
E45P Fiammata Nat. Rett. ● 85

MOSAICO ARELLA*



21x60 - 8¹/₄"x23⁵/₈"
E46L Spazzolata Nat. ● 100



21x60 - 8¹/₄"x23⁵/₈"
E46N Fiammata Nat. ● 100

MOSAICO 5X5*

Tessera - Chip 4,8x4,8 - 1⁷/₈"x1⁷/₈"

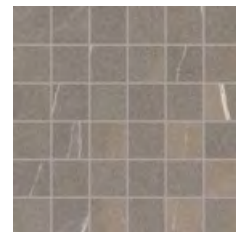

30x30 - 11¹³/₁₆"x11¹³/₁₆"
E458 Spazzolata Nat. ● 93

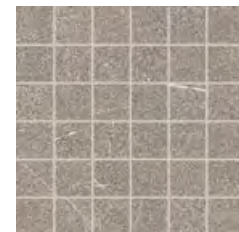

30x30 - 11¹³/₁₆"x11¹³/₁₆"
E45A Fiammata Nat. ● 93

LISTELLI SFALSATI*

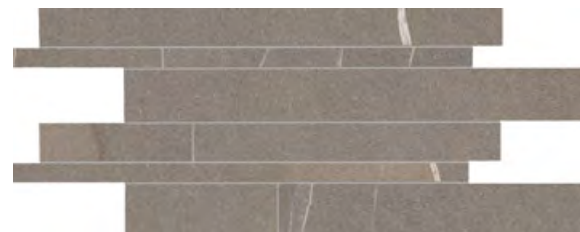

30x60 - 11¹³/₁₆"x23⁵/₈"
E45F Spazzolata Nat. ● 87



30x60 - 11¹³/₁₆"x23⁵/₈"
E45H Fiammata Nat. ● 87

* Su rete in fibra - On fibre mesh backing - Sur filet en fibre de verre - Auf Glasfasernetz - Sobre malla de fibra - На волоконной сетке

PEZZI SPECIALI

10 mm. Trims | Pieces Speciales | Formteile | Piezas Especiales | Специальные Изделия

	Dimensione Size	Spazzolata	Fiammata	Fascia di prezzo Price band		
 Battiscopa - Skirting	Nat. Rett. 7x60 - 2 ³ / ₄ "x23 ⁵ / ₈ " Pcs. Box 14 - LM x Box 8,40	E43Z	E441	● 11		
	Nat. Rett. 4,6x90 - 1 ¹³ / ₁₆ "x35 ⁷ / ₁₆ " Pcs. Box 8 - LM x Box 7,20	E46E	E46G	● 17		
 Gradino - Stair Tread	Nat. Rett. 33x60 - 12 ¹⁵ / ₁₆ "x23 ⁵ / ₈ " Pcs. Box 6 - LM x Box 3,60	EAQF	EAQH	● 61		
	Nat. Rett. 33x60 - 12 ¹⁵ / ₁₆ "x23 ⁵ / ₈ " Pcs. Box 6 - LM x Box 3,60	EC9J	EAQJ	● 61		
 Gradone - Step	Nat. Rett. 33x60x3,2x3,2 12 ¹⁵ / ₁₆ "x23 ⁵ / ₈ "x1 ¹ / ₄ "x1 ¹ / ₄ " Pcs. Box 4 - LM x Box 2,40	EAPW	EAPY	● 79		
	Nat. Rett. 33x120x3,2x3,2 12 ¹⁵ / ₁₆ "x47 ¹ / ₄ "x1 ¹ / ₄ "x1 ¹ / ₄ " Pcs. Box 2 - LM x Box 2,40	ECCN	ECCQ	● 95		
 Angolare Dx Sx Corner Tile Dx Sx	Nat. Rett. 33x60x3,2x3,2 12 ¹⁵ / ₁₆ "x23 ⁵ / ₈ "x1 ¹ / ₄ "x1 ¹ / ₄ " Pcs. Box 4 - LM x Box 2,40	DX EAQ3	SX EAQ4	DX EAQ7	SX EAQ8	● 93
	Nat. Rett. 33x120x3,2x3,2 12 ¹⁵ / ₁₆ "x47 ¹ / ₄ "x1 ¹ / ₄ "x1 ¹ / ₄ " Pcs. Box 2 - LM x Box 2,40	DX ECCA	SX ECCC	DX ECCF	SX ECCG	● 100
 Elemento a "L" - L Shaped Piece	Outdoor Nat. Rett. 15x60x5 5 ⁷ / ₈ "x23 ⁵ / ₈ "x1 ¹⁵ / ₁₆ " Pcs. Box 4 - LM x Box 2,40	EC9K	EAQN	● 43		

Brick PEZZI SPECIALI



Trims | Pieces Speciales | Formteile | Piezas Especiales | Специальные Изделия

	Dimensione Size	Spazzolata	Fiammata	Spacco Multicolor	Fascia di prezzo Price band
 Becco Civetta - Bullnose	Nat. 6x25 - 2 ³ / ₈ "x9 ¹³ / ₁₆ " Pcs. Box 34	EAR5	EAR6	EAR7	● 7
 Cove Base*	Nat. 16x30 - 6 ⁵ / ₁₆ "x11 ¹³ / ₁₆ " Pcs. Box 30	EAQM	EAQQ	EAQR	● 28
 Cove Base Ang. Int.* Cove Base In Corner	Nat. 2,5x16 - 15 ¹ / ₁₆ "x6 ⁵ / ₁₆ " Pcs. Box 10	EAQZ	EAR0	EAR1	● 26
 Cove Base Ang. Est.* Cove Base Out Corner	Nat. 2,5x16 - 15 ¹ / ₁₆ "x6 ⁵ / ₁₆ " Pcs. Box 10	EAQU	EAQV	EAQW	● 26

*Ordine minimo 500 pezzi - Minimum order: 500 pieces - Commande minimale 500 pièces
Mindestbestellmenge 500 Stücke - Pedido mínimo 500 piezas - Минимальный заказ - 500 штук

20MM PEZZI SPECIALI

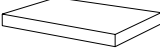
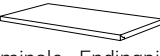
Trims | Pieces Speciales | Formteile | Piezas Especiales | Специальные Изделия

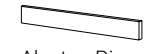
Dimensione Size	Spazzolata		Fiammata		Fascia di prezzo Price band
 Gradone - Step Nat. Rett. 33x60x5 12 ^{15/16} x23 ^{5/8} x1 ^{15/16} Pcs. Box 2 - LM x Box 1,20	EC87		EARA		● 83
 Angolare Dx Sx Corner Tile Dx Sx Nat. Rett. 33x60x5 12 ^{15/16} x23 ^{5/8} x1 ^{15/16} Pcs. Box 2 - LM x Box 1,20	DX EC88	SX EC89	DX EARC	SX EARD	● 93
 Terminale - Endingpiece Nat. Rett. 33x60x2,5 12 ^{15/16} x23 ^{5/8} x1 ^{15/16} Pcs. Box 2 - LM x Box 1,20	EC8A		EARE		● 83
 Ang. Terminale Dx Sx Endingpiece Corner Dx Sx Nat. Rett. 33x60x2,5 12 ^{15/16} x23 ^{5/8} x1 ^{15/16} Pcs. Box 2 - LM x Box 1,20	DX EC8C	SX EC8D	DX EARF	SX EARG	● 93
 Gradino - Stair Tread Nat. Rett. 33x60 - 12 ^{15/16} x23 ^{5/8} Pcs. Box 2 - LM x Box 1,20	EC8F		EARJ		● 77
 Alzata - Riser Nat. Rett. 16,5x60 - 6 ^{1/2} x23 ^{5/8} Pcs. Box 2 - LM x Box 1,20	EC86		EAR4		● 40

IMBALLI E PESI

Packing and Weight | Emballages et Poids | Verpackung und Gewicht | Embalajes y Pesos | Упаковка и Вес

Formato Size Format Format Татапо Формат cm	Spessore Thickness Epaisseur Stärke Espesor Толщина mm	Pz. x Mq. Pieces x Sqm Pcs / M ² Stk. x Qm Pzs x Mc. Шт x Кв.М.	Pz. x Scat. Pieces x Box Pcs / Bte Stk. x Krt. Pzs x Caja Шт x Кор.	Mq. x Scat. Sqm x Box M ² / Bte Qm x Krt. Mc. x Caja Кв.М. x Кор.	Peso x Scat. Weight x Box Poids / Bte Gewicht x Krt. Peso x Caja Вес x Кор. Kg	Scat. x Pal. Boxes x Pal. Bte / Pal. Krt. x Pal. Cajas x Pal. Кор. x Подд.	Mq. x Pal. Sqm x Pal. M ² / Pal. Qm x Pal. Mc. x Pal. Кв.М x Подд.	Peso x Pal. Weight x Pal. Poids / Pal. Gewicht x Pal. Peso x Pal. Вес x Подд. Kg
60x120 Naturale	10	1,39	2	1,440	33,06	36	51,84	1190
90x90 Naturale	10	1,23	2	1,620	36,54	24	38,88	877
45x90 Naturale	10	2,47	3	1,215	27,64	32	38,88	884
60x60 Naturale	10	2,78	3	1,080	24,06	40	43,20	962
60x60 Naturale 20MM	20	2,78	2	0,720	31,87	32	23,04	1020
30x60 Naturale	10	5,56	6	1,080	24,04	40	43,20	962
6x25 Naturale	9	66,67	34	0,510	9,57	99	50,49	947
30x60 Listelli Sfalsati	10	5,56	4	0,720	16,72	30	21,60	502
21x60 Mosaico Arella	10	7,94	4	0,504	15	60	25,20	900
30x30 Mosaico	10	11,11	5	0,450	10,40	60	27,00	624
15x15 Decoro Ornamento	10	44,44	36	0,810	18,4	56	45,36	1030



Fiammata Outdoor R11 Nat. Rett.
30x60 - 11^{13/16}x23^{5/8}

Brick Spacco Multicolor Nat.
6x25 - 2^{3/8}x9^{13/16}

SLEEKWOOD

FORMATI

Sizes | Formats | Formate | Tamaños | Форматы

8 mm.

15x90 - 7⁷/₈"x35⁷/₁₆" Naturale

9 mm.

Chevron 11x54 - 4⁵/₁₆"x21¹/₄" Naturale

SUPERFICI

Finishes | Finitions | Oberflächen
Superficies | Отделка поверхности

NATURALE

R9 DIN 51130

A DIN 51097

Wet \geq 0,42 ANSI A 137.1-2012 DCOF (Section 9.6)

\geq 0,40 B.C.R.A.

SHADE VARIATIONS



V3 HIGH

DESTINAZIONI D'USO

Intended uses | Domaines d'application
Zweckbestimmung | Usos previstos | Назначение



Min. 7,5%



WHITE



BEIGE

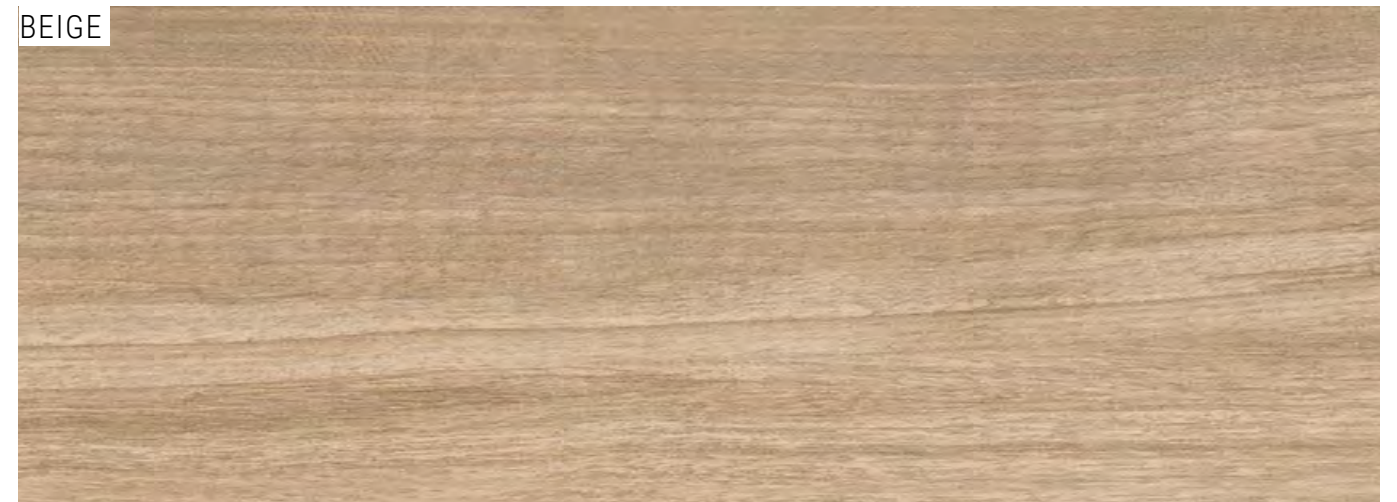

MOHOGANY



NUT



SLEEKWOOD

COLORI E FORMATI

Colours and Sizes | Couleurs et Formats | Farben und Formate | Colores y Tamaños | Цвета и Форматы

White



Beige



Mohogany

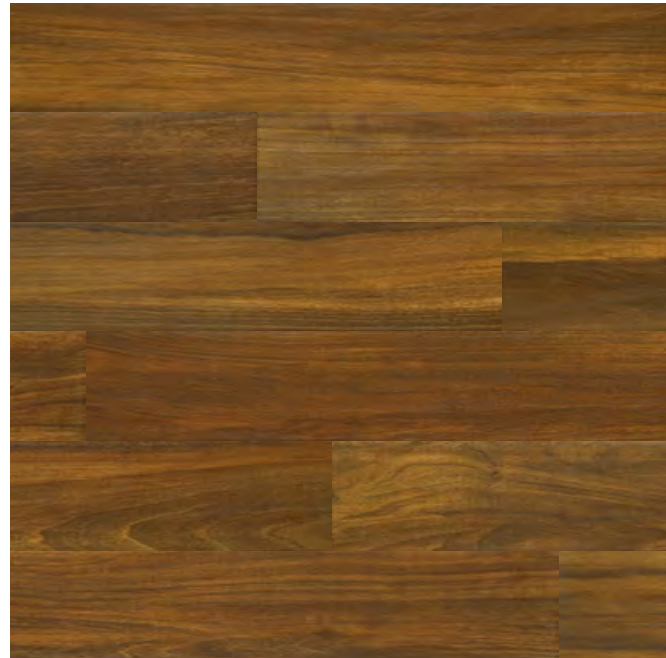

Nut



SLEEKWOOD

COLORI E FORMATI

Colours and Sizes | Couleurs et Formats | Farben und Formate | Colores y Tamaños | Цвета и Форматы

8 mm.

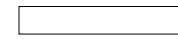

Naturale

15x90 - 5^{7/8}"x35^{7/16}"

- EFC2 White ● 54
- EFC4 Beige ● 54
- EFC3 Mohogany ● 54
- EFC5 Nut ● 54

9 mm.

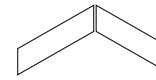

Naturale

Chevron 11x54 - 4^{5/16}"x21^{1/4}"

- EFCY White ● 59
- EFC0 Beige ● 59
- EFCZ Mohogany ● 59
- EFC1 Nut ● 59

PEZZI SPECIALI

Trims | Peces Speciales | Formteile | Piezas Especiales | Специальные Изделия

	Dimensione Size	 White	 Beige	 Mohogany	 Nut	Fascia di prezzo Price band
 Battiscopa - Skirting	Naturale 7x90 - 2 ^{3/4} "x35 ^{7/16} " Pcs. Box. 9 - LM x Box 8,10	EF1R	EF1S	EF1T	EF1U	● 14

IMBALLI E PESI

Packing and Weight | Emballages et Poids | Verpackung und Gewicht | Embalajes y Pesos | Упаковка и Вес

Formato Size Format Format Tamaño Формат cm	Spessore Thickness Epaisseur Stärke Espesor Толщина mm	Pz. x Mq. Pieces x Sqm Pcs / M ² Stk. x Qm Pzs x Mc. Шт x Кв.М.	Pz. x Scat. Pieces x Box Pcs / Bte Stk. x Krt. Pzs x Caja Шт x Кор.	Mq. x Scat. Sqm x Box M ² / Bte Qm x Krt. Mc. x Caja Кв.М. x Кор.	Peso x Scat. Weight x Box Poids / Bte Gewicht x Krt. Peso x Caja Вес x Кор. Kg	Scat. x Pal. Boxes x Pal. Bte / Pal. Krt. x Pal. Cajas x Pal. Кор. x Подд.	Mq. x Pal. Sqm x Pal. M ² / Pal. Qm x Pal. Mc. x Pal. Кв.М x Подд.	Peso x Pal. Weight x Pal. Poids / Pal. Gewicht x Pal. Peso x Pal. Вес x Подд. Kg
15x90 Naturale	8	7,41	8	1,080	19,68	48	51,84	945
11x54 Chevron	9	/	18	0,940	18,00	45	42,30	828

STONEBOX

FORMATI

Sizes | Formats | Formate | Tamaños | Форматы

10 mm.

45x90 - 17^{11/16}"x35^{7/16}" Naturale - Lappato

15x90 - 5^{7/8}"x35^{7/16}" Naturale - Lappato

30x60 - 11^{13/16}"x23^{5/8}" Naturale - Lappato

SUPERFICI

Finishes | Finitions | Oberflächen
Superficies | Отделка поверхности

NATURALE

R10 DIN 51130

B (A+B) DIN 51097

Wet \geq 0,50 ANSI A 137.1- 2012 DCOF (Section 9.6)

\geq 0,40 B.C.R.A.

- AS 4586: 2013

> 36 Low Slip potential BS 7976-2: 2002

2 ENV 12633-2006

LAPPATO

R9 DIN 51130

- DIN 51097

Wet \geq 0,42 ANSI A 137.1- 2012 DCOF (Section 9.6)

\geq 0,40 B.C.R.A.

- AS 4586: 2013

- BS 7976-2: 2002

- ENV 12633-2006

SHADE VARIATIONS



V3 HIGH

DESTINAZIONI D'USO

Intended uses | Domaines d'application
Zweckbestimmung | Usos previstos | Назначение



Min. 7,5%



SUGAR WHITE



TEA SAND



BRIGHT GREY



BLACK INK

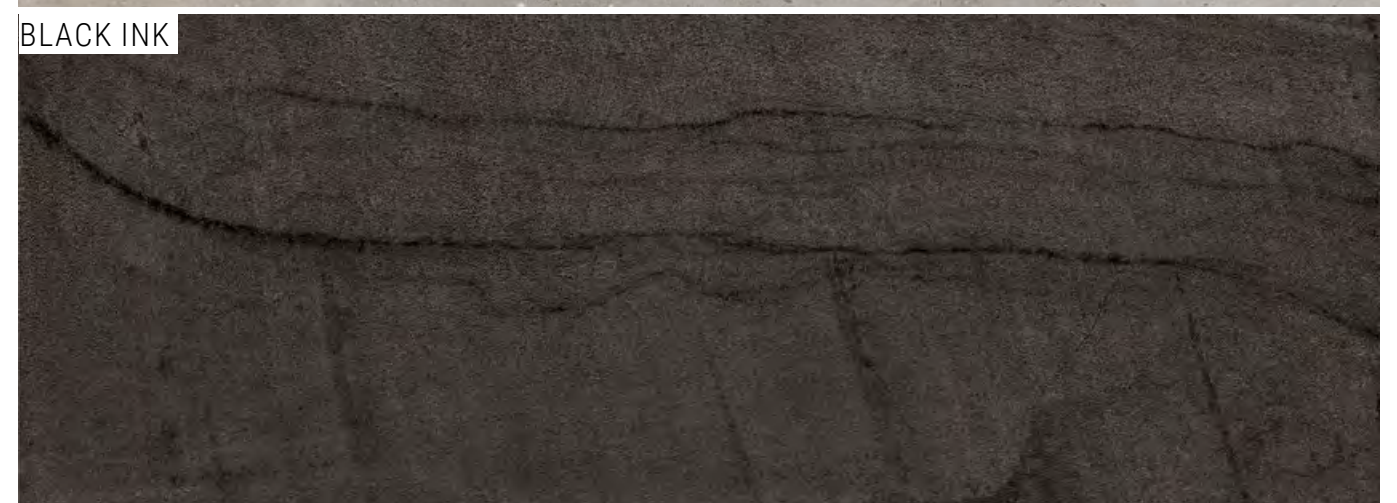

STONE BOX

COLORI E FORMATI

Colours and Sizes | Couleurs et Formats | Farben und Formate | Colores y Tamaños | Цвета и Форматы

Sugar White

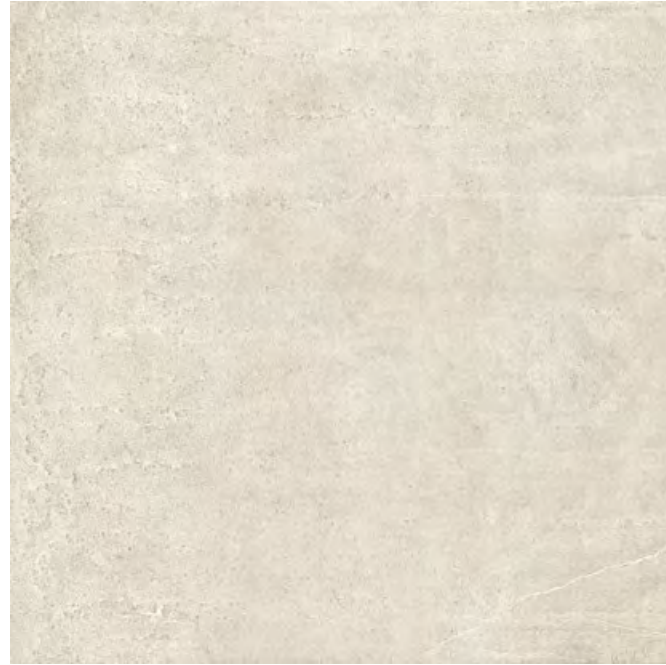

Tea Sand



Bright Grey



Black Ink



STONE BOX

COLORI E FORMATI

Colours and Sizes | Couleurs et Formats | Farben und Formate | Colores y Tamaños | Цвета и Форматы

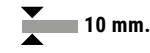

Naturale Rett.
45x90 - 17^{11/16}"x35^{7/16}"
E1UN Sugar White ● 74
E1UQ Tea Sand ● 74
E1US Bright Grey ● 74
E1UU Black Ink ● 74

Lappato Rett.
45x90 - 17^{11/16}"x35^{7/16}"
E1UM Sugar White ● 82
E1UP Tea Sand ● 82
E1UR Bright Grey ● 82
E1UT Black Ink ● 82



Naturale Rett.
15x90 - 5^{7/8}"x35^{7/16}"
E1UH Sugar White ● 771
E1UJ Tea Sand ● 771
E1UK Bright Grey ● 771
E1UL Black Ink ● 771

Lappato Rett.
15x90 - 5^{7/8}"x35^{7/16}"
E1V1 Sugar White ● 83
E73D Tea Sand ● 83
E1V2 Bright Grey ● 83
E1V3 Black Ink ● 83



Naturale Rett.
30x60 - 11^{13/16}"x23^{5/8}"
E1YS Sugar White ● 61
E1YU Tea Sand ● 61
E1YW Bright Grey ● 61
E1YY Black Ink ● 61

Lappato Rett.
30x60 - 11^{13/16}"x23^{5/8}"
E1YR Sugar White ● 73
E1YT Tea Sand ● 73
E1YV Bright Grey ● 73
E1YX Black Ink ● 73

Consigli di posa: per ottenere un risultato estetico ottimale, miscelare il materiale di scatole differenti. - Laying suggestions: to obtain excellent aesthetic results, it is recommended to mix the materials contained in different boxes. - Conseils de pose: pour obtenir d'excellents résultats du point de vue esthétique, mélangez les matériaux contenus dans des boîtes différentes. - Empfehlung für die Verlegung: um ein optimales ästhetisches Ergebnis zu erzielen, das Material der verschiedenen Schachteln mischen. - Consejos para la colocación: para obtener un resultado estético óptimo, mezclar el material de cajas diferentes. - Советы по укладке: Для достижения оптимального эстетического результата, рекомендуется смешивать материал из разных коробок.

Si consiglia la posa con fuga 2 mm. - Laying with a 2 mm-joint is recommended. - Pose recommandée avec joints de 2 mm. - Es wird eine Fugenbreite von 2 mm empfohlen. - Se recomienda la colocación con juntas de 2 mm. - Рекомендуется укладка с швом 2 мм.

DECORI

Decors | Decors | Dekore | Decorados | Декоры

MOSAICO MIX NAT.- LAPP.*

Tessera - Chip 2,8x2,8 - 1^{1/8}"x1^{1/8}"

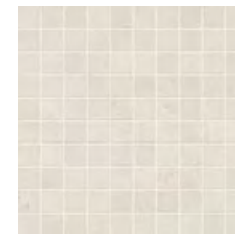

30x30 - 11^{13/16}"x11^{13/16}"
E1VF Sugar White ● 98



30x30 - 11^{13/16}"x11^{13/16}"
E1VG Tea Sand ● 98



30x30 - 11^{13/16}"x11^{13/16}"
E1VH Bright Grey ● 98

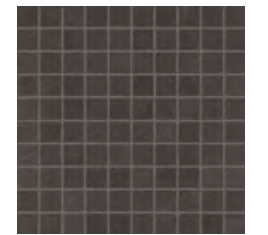

30x30 - 11^{13/16}"x11^{13/16}"
E1VJ Black Ink ● 98

* Su rete in fibra - On fibre mesh backing - Sur filet en fibre de verre - Auf Glasfasernetz - Sobre malla de fibra - На волоконной сетке

STONE BOX

PEZZI SPECIALI

Trims | Pieces Speciales | Formteile | Piezas Especiales | Специальные Изделия

	Dimensione Size	 Sugar White	 Tea Sand	 Bright Grey	 Black Ink	Fascia di prezzo Price band
 Battiscopa - Skirting	Nat. Rett. 7x60 - 2 ^{3/4} x23 ^{5/8} " Pcs. Box 14 - LM x Box 8,40	E1Z7	E1Z9	E1ZC	E1ZE	● 11
	Lapp. Rett. 7x60 - 2 ^{3/4} x23 ^{5/8} " Pcs. Box 14 - LM x Box 8,40	E1Z6	E1Z8	E1ZA	E1ZD	● 15
 Elemento a "L" - L Shaped Piece	Nat. Rett. 15x60x5 5 ^{7/8} x23 ^{5/8} x1 ^{15/16} " Pcs. Box 4 - LM x Box 2,40	E1ZF	E1ZG	E86J	E1ZH	● 43
	Nat. Rett. 30x60 - 11 ^{13/16} x23 ^{5/8} " Pcs. Box 6 - LM x Box 3,60	E86L	E86N	E86Q	E86S	● 51
 Gradino - Stair Tread	Lapp. Rett. 30x60 - 11 ^{13/16} x23 ^{5/8} " Pcs. Box 6 - LM x Box 3,60	E86K	E86M	E86P	E86R	● 56
	Nat. Rett. 30x60x3,2x3,2 11 ^{13/16} x23 ^{5/8} x1 ^{1/4} x1 ^{1/4} " Pcs. Box 4 - LM x Box 2,40	E1ZJ	E1ZK	E1ZL	E86X	● 79
 Gradone - Step	Lapp. Rett. 30x60x3,2x3,2 11 ^{13/16} x23 ^{5/8} x1 ^{1/4} x1 ^{1/4} " Pcs. Box 4 - LM x Box 2,40	E86T	E86U	E86V	E86W	● 81
	Nat. Rett. 30x30x3,2x3,2 11 ^{13/16} x11 ^{13/16} x1 ^{1/4} x1 ^{1/4} " Pcs. Box 2 - LM x Box 0,60	E863	E865	E867	E869	● 83
 Angolare Dx Sx Corner Tile Dx Sx	Lapp. Rett. 30x30x3,2x3,2 11 ^{13/16} x11 ^{13/16} x1 ^{1/4} x1 ^{1/4} " Pcs. Box 2 - LM x Box 0,60	E862	E864	E866	E868	● 85

IMBALLI E PESI

Packing and Weight | Emballages et Poids | Verpackung und Gewicht | Embalajes y Pesos | Упаковка и Вес

Formato Size Format Format Тamaño Формат cm	Spessore Thickness Epaisseur Stärke Espesor Толщина mm	Pz. x Mq. Pieces x Sqm Pcs / M ² Stk. x Qm Pzs x Mc. Шт x Кв.М.	Pz. x Scat. Pieces x Box Pcs / Bte Stk. x Krt. Pzs x Caja Шт x Кор.	Mq. x Scat. Sqm x Box M ² / Bte Qm x Krt. Mc. x Caja Кв.М. x Кор.	Peso x Scat. Weight x Box Poids / Bte Gewicht x Krt. Peso x Caja Вес x Кор. Kg	Scat. x Pal. Boxes x Pal. Bte / Pal. Krt. x Pal. Cajas x Pal. Кор. x Подд.	Mq. x Pal. Sqm x Pal. M ² / Pal. Qm x Pal. Mc. x Pal. Кв.М x Подд.	Peso x Pal. Weight x Pal. Poids / Pal. Gewicht x Pal. Peso x Pal. Вес x Подд. Kg
45x90 Naturale - Lappato	10	2,47	3	1,215	27,1	32	38,88	867
15x90 Naturale - Lappato	10	7,41	7	0,945	20,81	45	42,53	936
30x60 Naturale - Lappato	10	5,56	6	1,080	23,75	40	43,20	950
30x30 Mosaico	10	11,11	5	0,450	10,50	60	27,00	630



Bright Grey Nat. Rett.
15x90 - 5^{7/8}x35^{7/16}"

Bright Grey Lapp. Rett.
45x90 - 17^{11/16}x35^{7/16}"

FORMATI

Sizes | Formats | Formate | Tamaños | Форматы

6,5 mm.

120x240 - 47^{1/4}"x94^{1/2}" Naturale - Full Lappato

120x120 - 47^{1/4}"x47^{1/4}" Naturale - Full Lappato

10 mm.

90x90 - 35^{7/16}"x35^{7/16}" Full Lappato

60x120 - 23^{5/8}"x47^{1/4}" Naturale - Full Lappato

30x60 - 11^{13/16}"x23^{5/8}" Naturale - Full Lappato

7,5x30 - 2^{15/16}"x11^{13/16}" Naturale

SUPERFICI

Finishes | Finitions | Oberflächen
Superficies | Отделка поверхности

NATURALE

R9 DIN 51130

A DIN 51097

Wet $\geq 0,42$ ANSI A 137.1- 2012 DCOF (Section 9.6)

$\geq 0,40$ B.C.R.A.

- AS 4586: 2013

- BS 7976-2: 2002

- ENV 12633-2006

FULL LAPPATO

- DIN 51130

- DIN 51097

- ANSI A 137.1- 2012 DCOF (Section 9.6)

- B.C.R.A.

- AS 4586: 2013

- BS 7976-2: 2002

- ENV 12633-2006

SHADE VARIATIONS



V3 HIGH

DESTINAZIONI D'USO

Intended uses | Domaines d'application
Zweckbestimmung | Usos previstos | Назначение



Min. 7,5%



STATUARIO MICHELANGELO

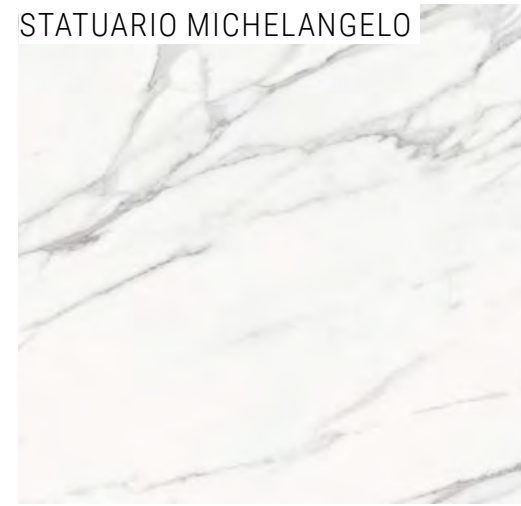

Doghe

Battuto di listelli



Seminato di tessere

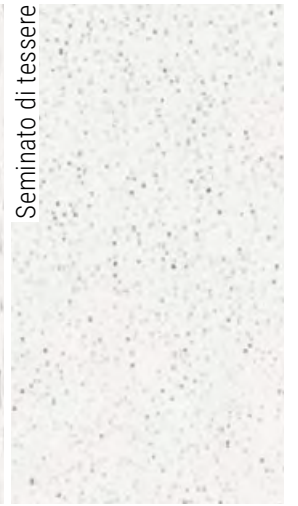

BRECCIA BRAQUE



Doghe

Battuto di listelli



Seminato di tessere

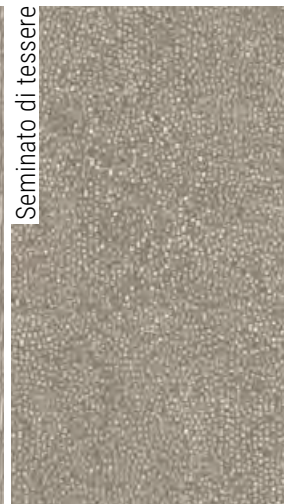

FRAPPUCCINO POLLOCK



Doghe

Battuto di listelli



Seminato di tessere

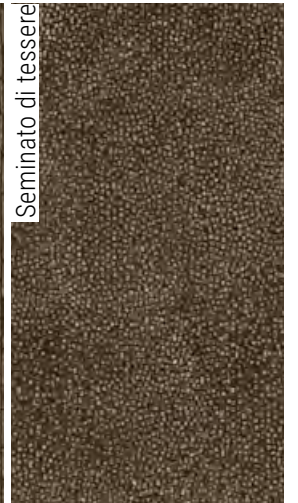

CALACATTA RENOIR



Doghe

Battuto di listelli



Seminato di tessere

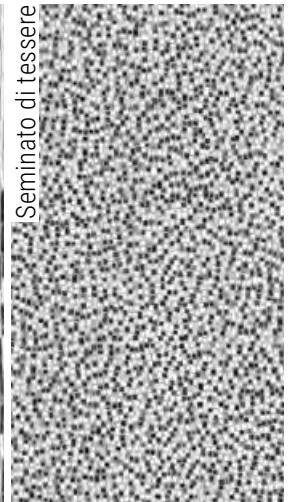

TELE DI MARMO

COLORI E FORMATI

Colours and Sizes | Couleurs et Formats | Farben und Formate | Colores y Tamaños | Цвета и Форматы

Statuario Michelangelo



Doghe



Battuto di listelli



Seminato di tessere



TELE DI MARMO

COLORI E FORMATI

Colours and Sizes | Couleurs et Formats | Farben und Formate | Colores y Tamaños | Цвета и Форматы

6,5 mm.

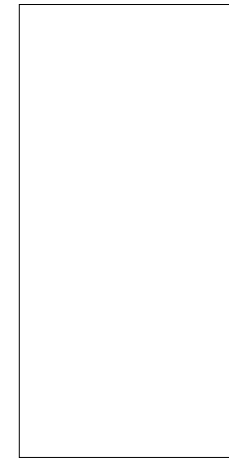

Naturale Rett.
120x240 - 47^{1/4}"x94^{1/2}"
EDCH Statuario Michel. ● 89

Full Lappato Rett.
120x240 - 47^{1/4}"x94^{1/2}"
ED2V Statuario Michel. ● 93

Doghe Full Lappato Rett.
120x240 - 47^{1/4}"x94^{1/2}"
ED2Y Statuario Michelangelo ● 93

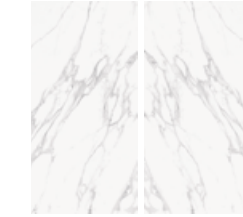

Battuto di listelli Full Lapp. Rett.
120x240 - 47^{1/4}"x94^{1/2}"
ED2W Statuario Michelangelo ● 93

Seminato di tessere Full Lapp. Rett.
120x240 - 47^{1/4}"x94^{1/2}"
ED2X Statuario Michelangelo ● 93

EEUT Statuario Michel. ● 93

Book Match A

EEUU Statuario Michel. ● 93

Book Match B

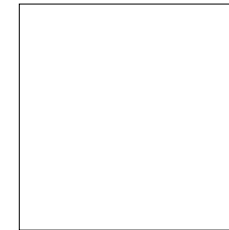

Naturale Rett.
120x120 - 47^{1/4}"x47^{1/4}"
EDCD Statuario Michel. ● 87

Full Lappato Rett.
120x120 - 47^{1/4}"x47^{1/4}"
ED2D Statuario Michel. ● 91

Doghe Full Lappato Rett.
120x120 - 47^{1/4}"x47^{1/4}"
ED2G Statuario Michelangelo ● 91

Battuto di listelli Full Lapp. Rett.
120x120 - 47^{1/4}"x47^{1/4}"
ED2E Statuario Michelangelo ● 91

Seminato di tessere Full Lapp. Rett.
120x120 - 47^{1/4}"x47^{1/4}"
ED2F Statuario Michelangelo ● 91

10 mm.

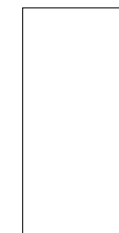

Naturale Rett.
60x120 - 23^{5/8}"x47^{1/4}"
ED47 Statuario Michel. ● 771

Full Lappato Rett.
60x120 - 23^{5/8}"x47^{1/4}"
ED3R Statuario Michel. ● 83

Doghe Full Lappato Rett.
60x120 - 23^{5/8}"x47^{1/4}"
ED3U Statuario Michelangelo ● 83

Battuto di listelli Full Lapp. Rett.
60x120 - 23^{5/8}"x47^{1/4}"
ED3S Statuario Michelangelo ● 83

Seminato di tessere Full Lapp. Rett.
60x120 - 23^{5/8}"x47^{1/4}"
ED3T Statuario Michelangelo ● 83

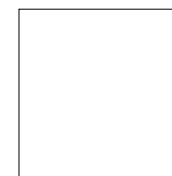

Full Lappato Rett.
90x90 - 35^{7/16}"x35^{7/16}"
ED3C Statuario Michel. ● 86



Naturale Rett.
30x60 - 11^{13/16}"x23^{5/8}"
ED3M Statuario Michel. ● 61

Full Lappato Rett.
30x60 - 11^{13/16}"x23^{5/8}"
EEXP Statuario Michel. ● 78



Naturale Rett.
7,5x30 - 2^{15/16}"x11^{13/16}"
EDMG Statuario Michel. ● 81

Si consiglia la posa con fuga 2 mm. - Laying with a 2 mm-joint is recommended. - Pose recommandée avec joints de 2 mm.
Es wird eine Fugenbreite von 2 mm empfohlen. - Se recomienda la colocación con juntas de 2 mm. - Рекомендуются укладка с швом 2 мм.

TELE DI MARMO

COLORI E FORMATI

Colours and Sizes | Couleurs et Formats | Farben und Formate | Colores y Tamaños | Цвета и Форматы

Breccia Braque



Doghe



Battuto di listelli

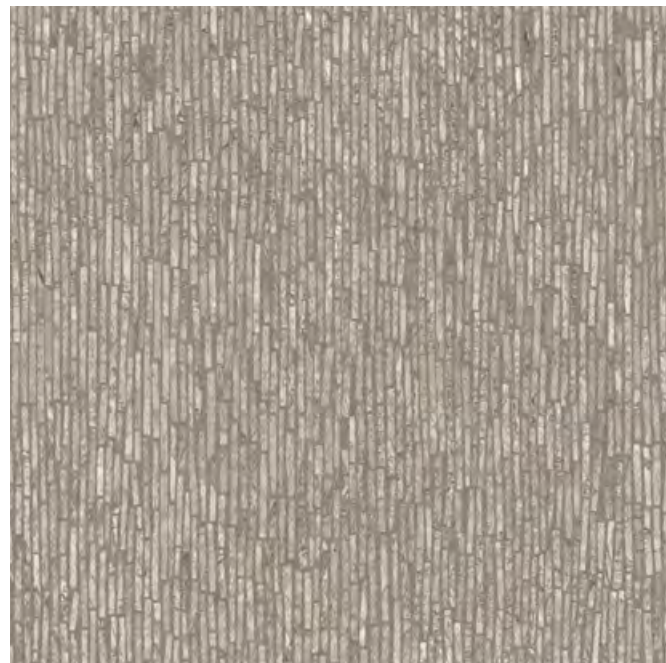

Seminato di tessere

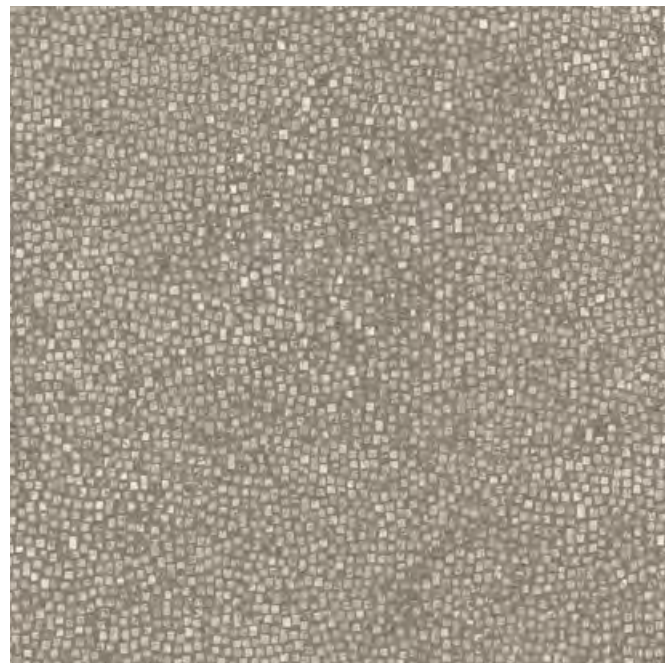

TELE DI MARMO

COLORI E FORMATI

Colours and Sizes | Couleurs et Formats | Farben und Formate | Colores y Tamaños | Цвета и Форматы

6,5 mm.

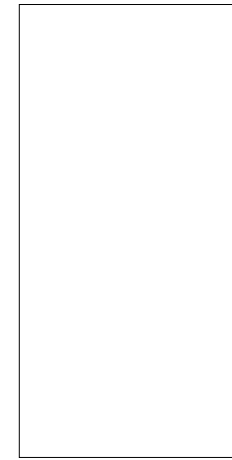

Naturale Rett.
120x240 - 47^{1/4}"x94^{1/2}"
EDCK Breccia Braque ● 89

Full Lappato Rett.
120x240 - 47^{1/4}"x94^{1/2}"
ED33 Breccia Braque ● 93

Doghe Full Lappato Rett.
120x240 - 47^{1/4}"x94^{1/2}"
ED36 Breccia Braque ● 93

Battuto di listelli Full Lapp. Rett.
120x240 - 47^{1/4}"x94^{1/2}"
ED34 Breccia Braque ● 93

Seminato di tessere Full Lapp. Rett.
120x240 - 47^{1/4}"x94^{1/2}"
ED35 Breccia Braque ● 93

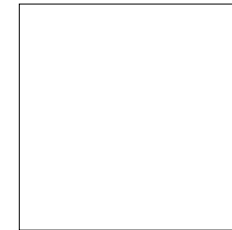

Naturale Rett.
120x120 - 47^{1/4}"x47^{1/4}"
EDCF Breccia Braque ● 87

Full Lappato Rett.
120x120 - 47^{1/4}"x47^{1/4}"
ED2M Breccia Braque ● 91

Doghe Full Lappato Rett.
120x120 - 47^{1/4}"x47^{1/4}"
ED2Q Breccia Braque ● 91

Battuto di listelli Full Lapp. Rett.
120x120 - 47^{1/4}"x47^{1/4}"
ED2N Breccia Braque ● 91

Seminato di tessere Full Lapp. Rett.
120x120 - 47^{1/4}"x47^{1/4}"
ED2P Breccia Braque ● 91

10 mm.

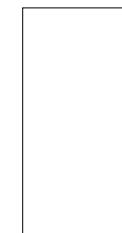

Naturale Rett.
60x120 - 23^{5/8}"x47^{1/4}"
ED49 Breccia Braque ● 771

Full Lappato Rett.
60x120 - 23^{5/8}"x47^{1/4}"
ED3Z Breccia Braque ● 83

Doghe Full Lappato Rett.
60x120 - 23^{5/8}"x47^{1/4}"
ED42 Breccia Braque ● 83

Battuto di listelli Full Lapp. Rett.
60x120 - 23^{5/8}"x47^{1/4}"
ED40 Breccia Braque ● 83

Seminato di tessere Full Lapp. Rett.
60x120 - 23^{5/8}"x47^{1/4}"
ED41 Breccia Braque ● 83

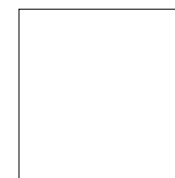

Full Lappato Rett.
90x90 - 35^{7/16}"x35^{7/16}"
ED3E Breccia Braque ● 86



Naturale Rett.
30x60 - 11^{13/16}"x23^{5/8}"
ED3P Breccia Braque ● 61

Full Lappato Rett.
30x60 - 11^{13/16}"x23^{5/8}"
EOPY Breccia Braque ● 78



Naturale Rett.
7,5x30 - 2^{15/16}"x11^{13/16}"
EDMJ Breccia Braque ● 81

Si consiglia la posa con fuga 2 mm. - Laying with a 2 mm-joint is recommended. - Pose recommandée avec joints de 2 mm.
Es wird eine Fugenbreite von 2 mm empfohlen. - Se recomienda la colocación con juntas de 2 mm. - Рекомендуются укладка с швом 2 мм.

TELE DI MARMO

COLORI E FORMATI

Colours and Sizes | Couleurs et Formats | Farben und Formate | Colores y Tamaños | Цвета и Форматы

Frappuccino Pollock

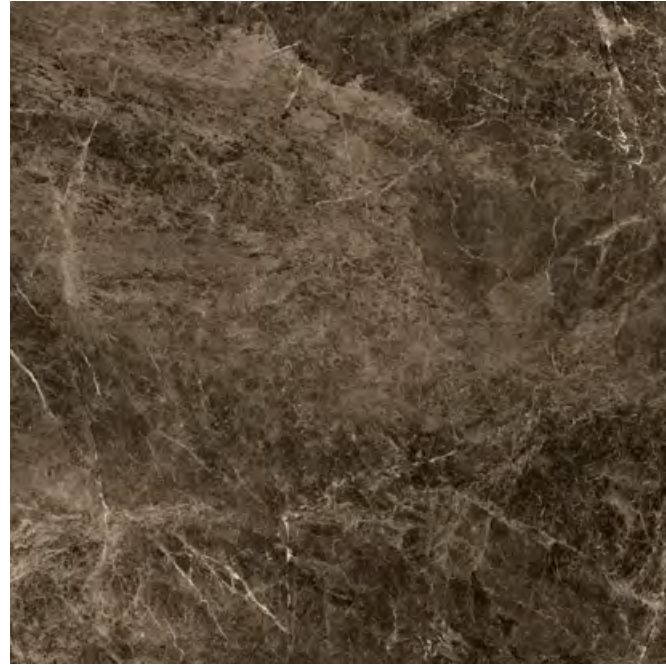

Doghe



Battuto di listelli

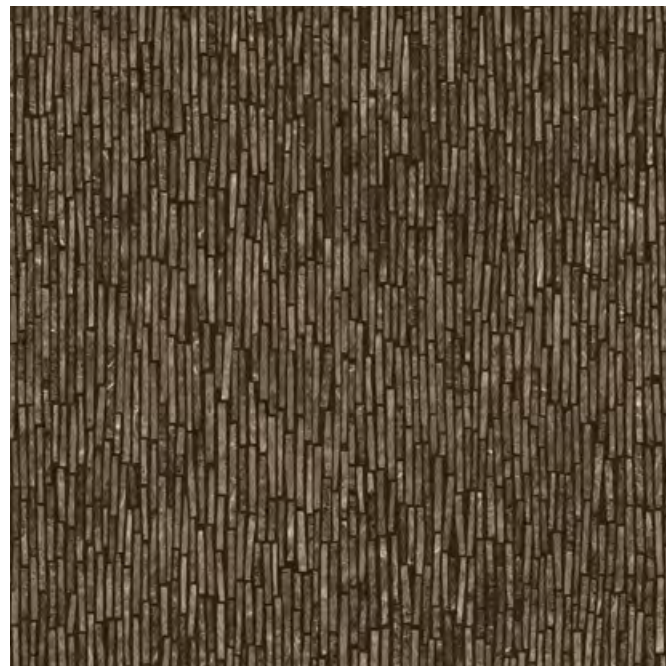

Seminato di tessere

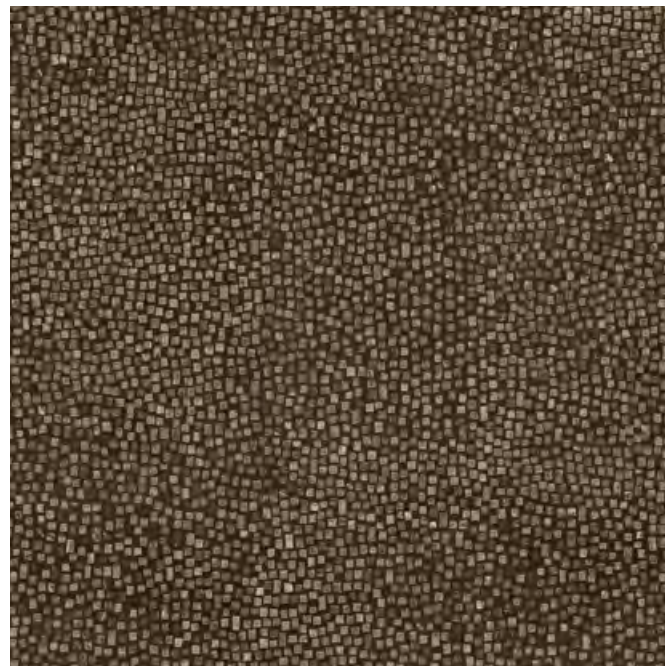

TELE DI MARMO

COLORI E FORMATI

Colours and Sizes | Couleurs et Formats | Farben und Formate | Colores y Tamaños | Цвета и Форматы

6,5 mm.

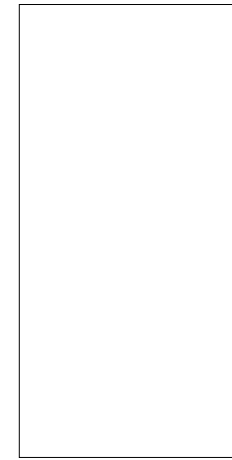

Naturale Rett.
120x240 - 47^{1/4}"x94^{1/2}"
EDCJ Frapp. Pollock ● 89

Full Lappato Rett.
120x240 - 47^{1/4}"x94^{1/2}"
ED2Z Frapp. Pollock ● 93

Doghe Full Lappato Rett.
120x240 - 47^{1/4}"x94^{1/2}"
ED32 Frappuccino Pollock ● 93

Battuto di listelli Full Lapp. Rett.
120x240 - 47^{1/4}"x94^{1/2}"
ED30 Frappuccino Pollock ● 93

Seminato di tessere Full Lapp. Rett.
120x240 - 47^{1/4}"x94^{1/2}"
ED31 Frappuccino Pollock ● 93

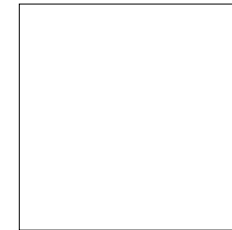

Naturale Rett.
120x120 - 47^{1/4}"x47^{1/4}"
EDCE Frapp. Pollock ● 87

Full Lappato Rett.
120x120 - 47^{1/4}"x47^{1/4}"
ED2H Frapp. Pollock ● 91

Doghe Full Lappato Rett.
120x120 - 47^{1/4}"x47^{1/4}"
ED2L Frappuccino Pollock ● 91

Battuto di listelli Full Lapp. Rett.
120x120 - 47^{1/4}"x47^{1/4}"
ED2J Frappuccino Pollock ● 91

Seminato di tessere Full Lapp. Rett.
120x120 - 47^{1/4}"x47^{1/4}"
ED2K Frappuccino Pollock ● 91

10 mm.

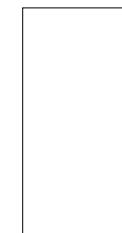

Naturale Rett.
60x120 - 23^{5/8}"x47^{1/4}"
ED48 Frapp. Pollock ● 771

Full Lappato Rett.
60x120 - 23^{5/8}"x47^{1/4}"
ED3V Frapp. Pollock ● 83

Doghe Full Lappato Rett.
60x120 - 23^{5/8}"x47^{1/4}"
ED3Y Frappuccino Pollock ● 83

Battuto di listelli Full Lapp. Rett.
60x120 - 23^{5/8}"x47^{1/4}"
ED3W Frappuccino Pollock ● 83

Seminato di tessere Full Lapp. Rett.
60x120 - 23^{5/8}"x47^{1/4}"
ED3X Frappuccino Pollock ● 83



Full Lappato Rett.
90x90 - 35^{7/16}"x35^{7/16}"
ED3D Frapp. Pollock ● 86



Naturale Rett.
30x60 - 11^{13/16}"x23^{5/8}"
ED3N Frapp. Pollock ● 61

Full Lappato Rett.
30x60 - 11^{13/16}"x23^{5/8}"
EEPZ Frapp. Pollock ● 78



Naturale Rett.
7,5x30 - 2^{15/16}"x11^{13/16}"
EDMH Frapp. Pollock ● 81

Si consiglia la posa con fuga 2 mm. - Laying with a 2 mm-joint is recommended. - Pose recommandée avec joints de 2 mm.
Es wird eine Fugenbreite von 2 mm empfohlen. - Se recomienda la colocación con juntas de 2 mm. - Рекомендуются укладка с швом 2 мм.

TELE DI MARMO

COLORI E FORMATI

Colours and Sizes | Couleurs et Formats | Farben und Formate | Colores y Tamaños | Цвета и Форматы

Calacatta Renoir

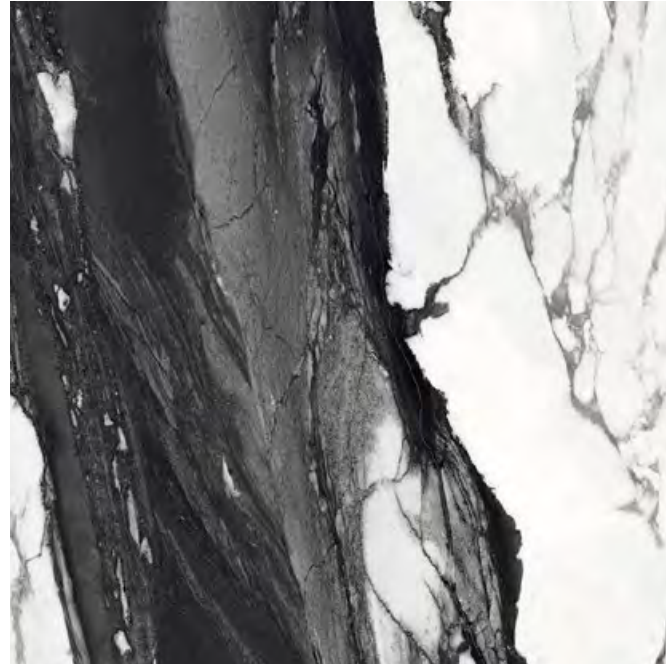

Doghe

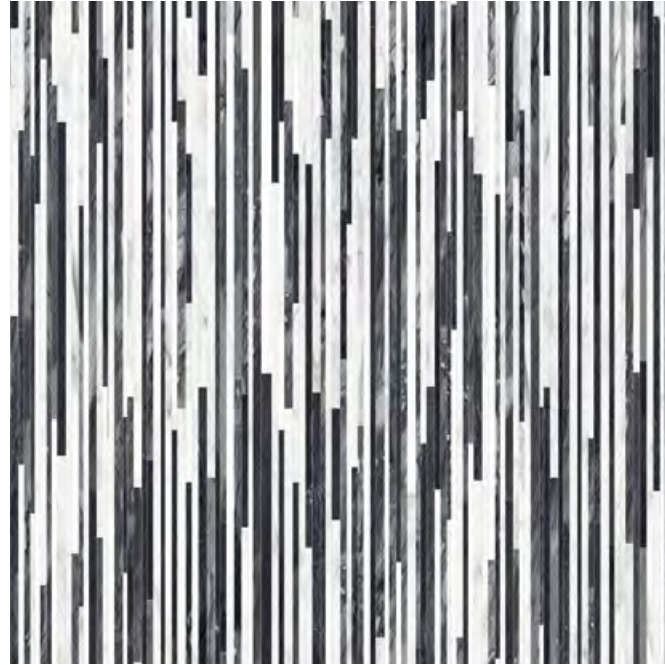

Battuto di listelli

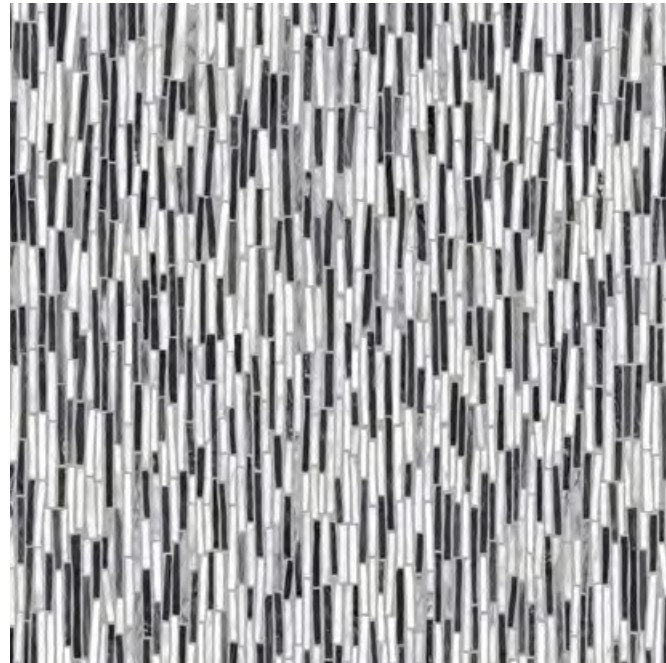

Seminato di tessere

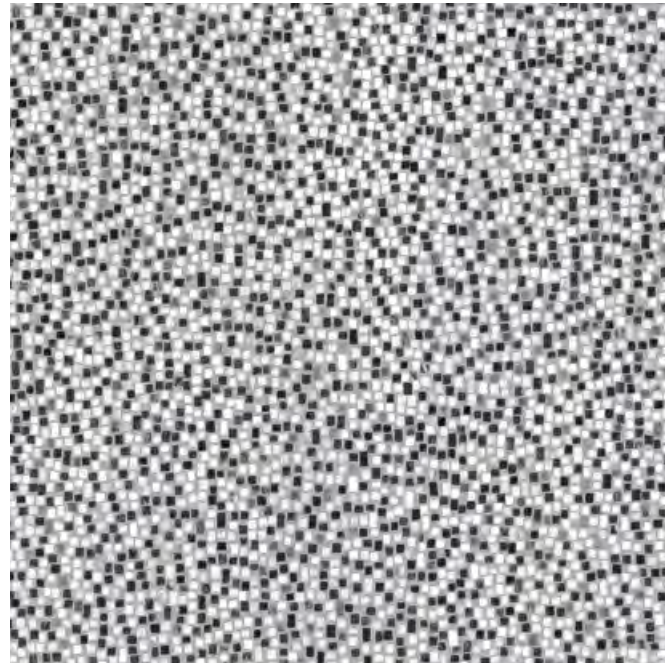

TELE DI MARMO

COLORI E FORMATI

Colours and Sizes | Couleurs et Formats | Farben und Formate | Colores y Tamaños | Цвета и Форматы

6,5 mm.

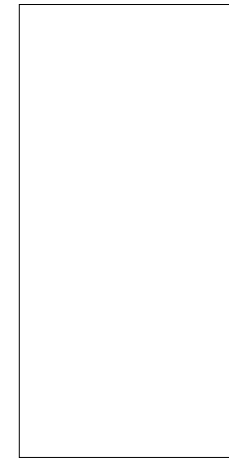

Naturale Rett.
120x240 - 47^{1/4}"x94^{1/2}"
EDCL Calacatta Renoir ● 89

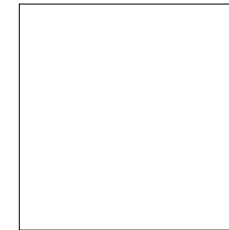

Naturale Rett.
120x120 - 47^{1/4}"x47^{1/4}"
EDCG Calacatta Renoir ● 87

Full Lappato Rett.
120x240 - 47^{1/4}"x94^{1/2}"
ED37 Calacatta Renoir ● 93

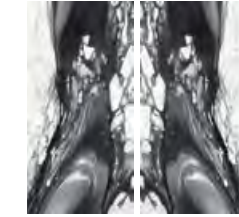

EEUV Calacatta Renoir ● 93
Book Match A
EEUW Calacatta Renoir ● 93
Book Match B

Doghe Full Lappato Rett.
120x240 - 47^{1/4}"x94^{1/2}"
ED3A Calacatta Renoir ● 93

Battuto di listelli Full Lapp. Rett.
120x240 - 47^{1/4}"x94^{1/2}"
ED38 Calacatta Renoir ● 93

Seminato di tessere Full Lapp. Rett.
120x240 - 47^{1/4}"x94^{1/2}"
ED39 Calacatta Renoir ● 93

Full Lappato Rett.
120x120 - 47^{1/4}"x47^{1/4}"
ED2R Calacatta Renoir ● 91

Doghe Full Lappato Rett.
120x120 - 47^{1/4}"x47^{1/4}"
ED2U Calacatta Renoir ● 91

Battuto di listelli Full Lapp. Rett.
120x120 - 47^{1/4}"x47^{1/4}"
ED2S Calacatta Renoir ● 91

Seminato di tessere Full Lapp. Rett.
120x120 - 47^{1/4}"x47^{1/4}"
ED2T Calacatta Renoir ● 91

10 mm.



Naturale Rett.
60x120 - 23^{5/8}"x47^{1/4}"
ED4A Calacatta Renoir ● 771

Full Lappato Rett.
60x120 - 23^{5/8}"x47^{1/4}"
ED43 Calacatta Renoir ● 83

Doghe Full Lappato Rett.
60x120 - 23^{5/8}"x47^{1/4}"
ED46 Calacatta Renoir ● 83

Battuto di listelli Full Lapp. Rett.
60x120 - 23^{5/8}"x47^{1/4}"
ED44 Calacatta Renoir ● 83

Seminato di tessere Full Lapp. Rett.
60x120 - 23^{5/8}"x47^{1/4}"
ED45 Calacatta Renoir ● 83

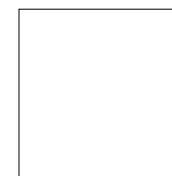

Full Lappato Rett.
90x90 - 35^{7/16}"x35^{7/16}"
ED3F Calacatta Renoir ● 86



Naturale Rett.
30x60 - 11^{13/16}"x23^{5/8}"
ED3Q Calacatta Renoir ● 61

Full Lappato Rett.
30x60 - 11^{13/16}"x23^{5/8}"
EEQ0 Calacatta Renoir ● 78



Naturale Rett.
7,5x30 - 2^{15/16}"x11^{13/16}"
EDMK Calacatta Renoir ● 81

Si consiglia la posa con fuga 2 mm. - Laying with a 2 mm-joint is recommended. - Pose recommandée avec joints de 2 mm.
Es wird eine Fugenbreite von 2 mm empfohlen. - Se recomienda la colocación con juntas de 2 mm. - Рекомендуются укладка с швом 2 мм.

TELE DI MARMO

DECORI

Decors | Decors | Dekore | Decorados | Декоры

TRAMA*



31,9x28,3 - 12⁹/₁₆"x11¹/₈"

EDPP

Statuario Michelangelo Nat. ● 98

EEGW

Statuario M. Full Lapp. ● 100



31,9x28,3 - 12⁹/₁₆"x11¹/₈"

EDPR

Breccia Braque Nat. ● 98

EEGX

Breccia B. Full Lapp. ● 100



31,9x28,3 - 12⁹/₁₆"x11¹/₈"

EDPQ

Frappuccino Pollock Nat. ● 98

EEGY

Frappuccino P. Full Lapp. ● 100



31,9x28,3 - 12⁹/₁₆"x11¹/₈"

EDPS

Calacatta Renoir Nat. ● 98

EEGZ

Calacatta R. Full Lapp. ● 100

INTRECCI*



30x30 - 11¹³/₁₆"x11¹³/₁₆"

EDT9

Statuario Michelangelo Nat. ● 100

EEHQ

Statuario M. Full Lapp. ● 1011



30x30 - 11¹³/₁₆"x11¹³/₁₆"

EDTC

Breccia Braque Nat. ● 100

EEHR

Breccia B. Full Lapp. ● 1011



30x30 - 11¹³/₁₆"x11¹³/₁₆"

EDTA

Frappuccino Pollock Nat. ● 100

EEHS

Frappuccino P. Full Lapp. ● 1011



30x30 - 11¹³/₁₆"x11¹³/₁₆"

EDTD

Calacatta Renoir Nat. ● 100

EEHT

Calacatta R. Full Lapp. ● 1011

LOSANGHE XS*



28,2x29,1 - 11¹/₈"x11⁷/₁₆"

EDT1

Statuario M. Full Lapp. ● 105



28,2x29,1 - 11¹/₈"x11⁷/₁₆"

EDT3

Breccia B. Full Lapp. ● 105



28,2x29,1 - 11¹/₈"x11⁷/₁₆"

EDT2

Frappuccino P. Full Lapp. ● 105



28,2x29,1 - 11¹/₈"x11⁷/₁₆"

EDT4

Calacatta R. Full Lapp. ● 105

* Su rete in fibra - On fibre mesh backing - Sur filet en fibre de verre - Auf Glasfasernetz - Sobre malla de fibra - На волоконной сетке

TELE DI MARMO

DECORI

Decors | Decors | Dekore | Decorados | Декоры

MOSAICO 3X3*

Tessera - Chip 2,8x2,8 - 1¹/₈"x1¹/₈"

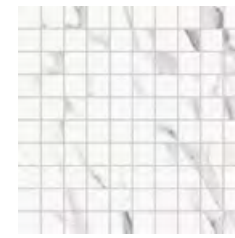

30x30 - 11¹³/₁₆"x11¹³/₁₆"

EDQ5

Statuario Michelangelo Nat. ● 98

EDQ6

Statuario M. Full Lapp. ● 101



30x30 - 11¹³/₁₆"x11¹³/₁₆"

EDQ9

Breccia Braque Nat. ● 98

EDQA

Breccia B. Full Lapp. ● 101

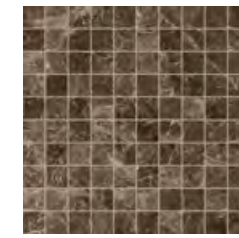

30x30 - 11¹³/₁₆"x11¹³/₁₆"

EDQ7

Frappuccino Pollock Nat. ● 98

EDQ8

Frappuccino P. Full Lapp. ● 101

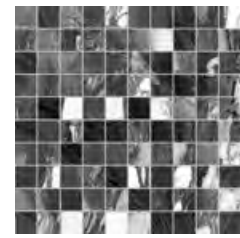

30x30 - 11¹³/₁₆"x11¹³/₁₆"

EDQC

Calacatta Renoir Nat. ● 98

EDQD

Calacatta R. Full Lapp. ● 101

MOSAICO 5X5*

Tessera - Chip 4,8x4,8 - 1⁷/₈"x1⁷/₈"

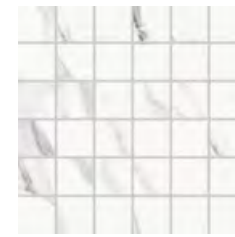

30x30 - 11¹³/₁₆"x11¹³/₁₆"

EDRK

Statuario Michelangelo Nat. ● 93

EEHA

Statuario M. Full Lapp. ● 96

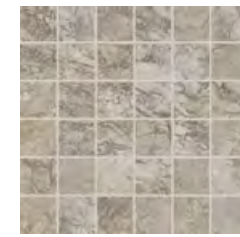

30x30 - 11¹³/₁₆"x11¹³/₁₆"

EDRM

Breccia Braque Nat. ● 93

EEHC

Breccia B. Full Lapp. ● 96

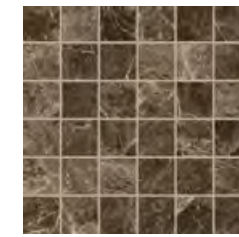

30x30 - 11¹³/₁₆"x11¹³/₁₆"

EDRL

Frappuccino Pollock Nat. ● 93

EEHD

Frappuccino P. Full Lapp. ● 96

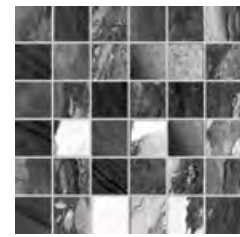

30x30 - 11¹³/₁₆"x11¹³/₁₆"

EDRN

Calacatta Renoir Nat. ● 93

EEHE

Calacatta R. Full Lapp. ● 96

LOSANGHE XL*



28,2x29,1 - 11¹/₈"x11⁷/₁₆"

EDT5

Statuario M. Full Lapp. ● 103



28,2x29,1 - 11¹/₈"x11⁷/₁₆"

EDT7

Breccia B. Full Lapp. ● 103



28,2x29,1 - 11¹/₈"x11⁷/₁₆"

EDT6

Frappuccino P. Full Lapp. ● 103



28,2x29,1 - 11¹/₈"x11⁷/₁₆"

EDT8

Calacatta R. Full Lapp. ● 103

* Su rete in fibra - On fibre mesh backing - Sur filet en fibre de verre - Auf Glasfasernetz - Sobre malla de fibra - На волоконной сетке

TELE DI MARMO

DECORI

Decors | Decors | Dekore | Decorados | Декоры

BACCHETTA



4x120 - 1 9/16 x 47 1/4"

EDSX Statuario Michelangelo Full Lappato

Pcs. Box 2 ● 59



4x240 - 1 9/16 x 94 1/2"

EDST Statuario Michelangelo Full Lappato

Pcs. Box 2 ● 86



4x120 - 1 9/16 x 47 1/4"

EDSZ Breccia Braque Full Lappato

Pcs. Box 2 ● 59



4x240 - 1 9/16 x 94 1/2"

EDSV Breccia Braque Full Lappato

Pcs. Box 2 ● 86



4x120 - 1 9/16 x 47 1/4"

EDSY Frappuccino Pollock Full Lappato

Pcs. Box 2 ● 59



4x240 - 1 9/16 x 94 1/2"

EDSU Frappuccino Pollock Full Lappato

Pcs. Box 2 ● 86



4x120 - 1 9/16 x 47 1/4"

EDTO Calacatta Renoir Full Lappato

Pcs. Box 2 ● 59



4x240 - 1 9/16 x 94 1/2"



EDSW Calacatta Renoir Full Lappato

Pcs. Box 2 ● 86

TELE DI MARMO

PEZZI SPECIALI

Trims | Pieces Speciales | Formteile | Piezas Especiales | Специальные Изделия



	Dimensione Size	 Statuario Michelangelo	 Breccia Braque	 Frappuccino Pollock	 Calacatta Renoir	Fascia di prezzo Price band				
	Nat. Rett. 7x60 - 2 3/4 x 23 5/8" Pcs. Box 14 - LM x Box 8,40	EDNN	EDNS	EDNQ	EDNU	● 11				
	Full Lapp. Rett. 7x60 - 2 3/4 x 23 5/8" Pcs. Box 14 - LM x Box 8,40	EDNP	EDNT	EDNR	EDNV	● 16				
	Nat. Rett. 4,6x90 - 1 13/16 x 35 7/16" Pcs. Box 8 - LM x Box 7,20	EDL4	EDL8	EDL6	EDLA	● 17				
	Full Lapp. Rett. 4,6x90 - 1 13/16 x 35 7/16" Pcs. Box 8 - LM x Box 7,20	EDL5	EDL9	EDL7	EDLC	● 20				
	Nat. Rett. 33x120x3,2x3,2 12 15/16 x 47 1/4 x 1 1/4 x 1 1/4" Pcs. Box 2 - LM x Box 2,40	EDM7	EDMC	EDM9	EDME	● 95				
	Full Lapp. Rett. 33x120x3,2x3,2 12 15/16 x 47 1/4 x 1 1/4 x 1 1/4" Pcs. Box 2 - LM x Box 2,40	EDM8	EDMD	EDMA	EDMF	● 97				
	Nat. Rett. 33x120x3,2x3,2 12 15/16 x 47 1/4 x 1 1/4 x 1 1/4" Pcs. Box 1 - LM x Box 1,20	DX EDKG	SX EDKH	DX EDKQ	SX EDKR	DX EDKL	SX EDKM	DX EDKU	SX EDKV	● 100
	Full Lapp. Rett. 33x120x3,2x3,2 12 15/16 x 47 1/4 x 1 1/4 x 1 1/4" Pcs. Box 1 - LM x Box 1,20	DX EDKJ	SX EDKK	DX EDKS	SX EDKT	DX EDKN	SX EDKP	DX EDKW	SX EDKX	● 101
	Nat. Rett. 15x15 - 5 7/8 x 5 7/8" Pcs. Box 16	EDTM	EDTP	EDTN	EDTQ	● 14				
	Nat. Rett. 15x15 - 5 7/8 x 5 7/8" Pcs. Box 4	EDTZ	EDU1	EDU0	EDU2	● 26				

IMBALLI E PESI

Packing and Weight | Emballages et Poids | Verpackung und Gewicht | Embalajes y Pesos | Упаковка и Вес

Formato Size Format Format Тamaño Формат cm	Spessore Thickness Epaisseur Stärke Espesor Толщина mm	Pz. x Mq. Pieces x Sqm Pcs / M ² Stk. x Qm Pzs x Mc. Шт x Кв.М.	Pz. x Scat. Pieces x Box Pcs / Bte Stk. x Krt. Pzs x Caja Шт x Кор.	Mq. x Scat. Sqm x Box M ² / Bte Qm x Krt. Mc. x Caja Кв.М. x Кор.	Peso x Scat. Weight x Box Poids / Bte Gewicht x Krt. Peso x Caja Вес x Кор. Kg	Scat. x Pal. Boxes x Pal. Bte / Pal. Krt. x Pal. Cajas x Pal. Кор. x Подд.	Mq. x Pal. Sqm x Pal. M ² / Pal. Qm x Pal. Mc. x Pal. Кв.М x Подд.	Peso x Pal. Weight x Pal. Poids / Pal. Gewicht x Pal. Peso x Pal. Вес x Подд. Kg
120x240 Nat. - Full Lappato	6,5	0,35	1	2,880	46,00			
120x120 Nat. - Full Lappato	6,5	0,69	1	1,440	22		vedi sotto - see below	
60x120 Nat. - Full Lappato	10	1,39	2	1,440	33,17	36	51,84	1194
90x90 Full Lappato	10	1,23	2	1,620	36,54	24	38,88	877
30x60 Nat. - Full Lappato	10	5,56	6	1,080	24,69	40	43,20	988
7,5x30 Naturale	10	44,44	36	0,810	18,38	56	45,36	1029
31,9x28,3 Trama Naturale- Full Lappato	10	11,08	5	0,450	10,40	60	27,00	624
30x30 Mosaico 5X5 Nat. - Full Lappato	10	11,11	5	0,450	10,50	60	27,00	630
30x30 Mosaico 3X3 Nat. - Full Lappato	10	11,11	5	0,450	10,42	60	27,00	625
30x30 Intrecci Nat. - Full Lappato	10	11,11	5	0,450	10,5	60	27,00	630
28,2x29,1 Losanghe XS/XL Full Lappato	10	12,19	5	0,410	10,3	60	24,60	618

Slabs 120x120 - 120x240

Articolo Item Reference Artikel Articulo Артикула	Dimensione (cm) Size (cm) Format (cm) Format (cm) Тamaño (cm) Формат (cm)	Nr. Lastre No. of Slabs Nbre Dalles Anz. Platten Nº de Placas Кол. Плит	Mq. x Imballo sqm per Pack m ² / Emballage qm pro Verpackung m ² por embalaje Кв.м. x упаковку	Peso Imballo (Kg) Weight of Packaging (kg) Poids Emballage (kg) Gewicht Verpackung (kg) Peso embalaje (kg) Вес упаковки (кг)	Peso Imballo+Lastre (Kg) Weight of Packaging + Slabs (kg) Poids Emballage+Dalles (kg) Gewicht Verpackung+Platten (kg) Peso embalaje + placas (kg) Вес упаковки + плит (кг)
 120x120 Cassa - Crate - Caisse Kiste - Caja - Ящик	139x139x41h	24	35,56	62,5	613,3
 120x240 Cassa - Crate - Caisse Kiste - Caja - Ящик	136x266x41h	20	57,60	99	1020,6
 120x240 Cavalletto - A-Frame Chevalet de transport - Transportgestell Caballete - Подставка	75x250x160h	40	115,20	163	2006,2

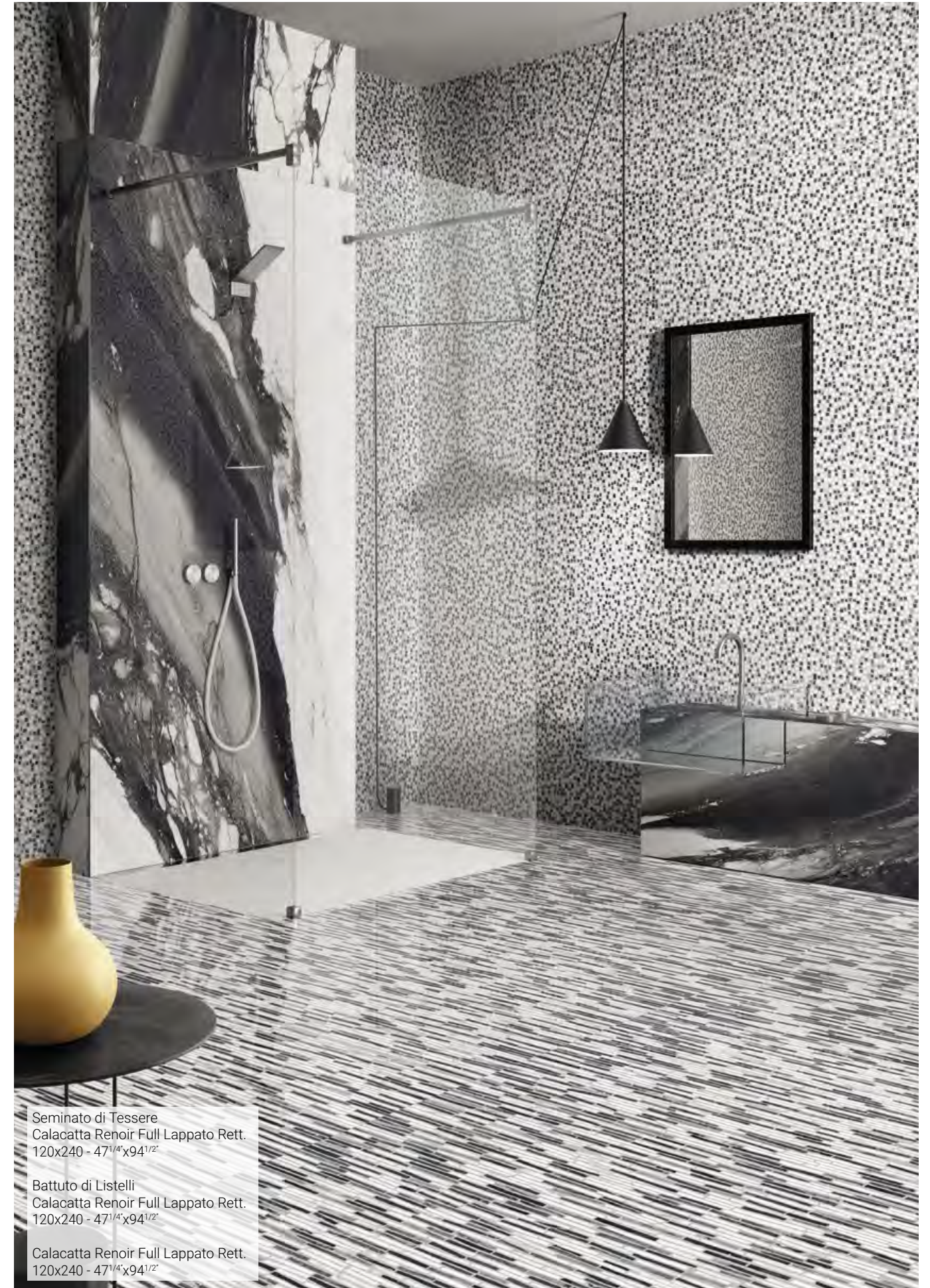

Seminato di Tessere
Calacatta Renoir Full Lappato Rett.
120x240 - 47^{1/4}x94^{1/2}"

Battuto di Listelli
Calacatta Renoir Full Lappato Rett.
120x240 - 47^{1/4}x94^{1/2}"

Calacatta Renoir Full Lappato Rett.
120x240 - 47^{1/4}x94^{1/2}"

TELE DI *Marmi* RELOADED

FORMATI

Sizes | Formats | Formate | Tamaños | Форматы

6,5 mm.

120x240 - 47^{1/4}"x94^{1/2}" Full Lappato

120x120 - 47^{1/4}"x47^{1/4}" Full Lappato

10 mm.

90x90 - 35^{7/16}"x35^{7/16}" Full Lappato

60x120 - 23^{5/8}"x47^{1/4}" Naturale - Full Lappato

30x60 - 11^{13/16}"x23^{5/8}" Naturale - Full Lappato

7,5x30 - 2^{15/16}"x11^{13/16}" Naturale

SUPERFICI

Finishes | Finitions | Oberflächen
Superficies | Отделка поверхности

NATURALE

R9 DIN 51130

A DIN 51097

Wet $\geq 0,42$ ANSI A 137.1- 2012 DCOF (Section 9.6)

$\geq 0,40$ B.C.R.A.

- AS 4586: 2013

- BS 7976-2: 2002

- ENV 12633-2006

FULL LAPPATO

- DIN 51130

- DIN 51097

- ANSI A 137.1- 2012 DCOF (Section 9.6)

- B.C.R.A.

- AS 4586: 2013

- BS 7976-2: 2002

- ENV 12633-2006

SHADE VARIATIONS



V3 HIGH

DESTINAZIONI D'USO

Intended uses | Domaines d'application
Zweckbestimmung | Usos previstos | Назначение



Min. 7,5%



QUARZO KANDINSKY



Doghe

Battuto di listelli

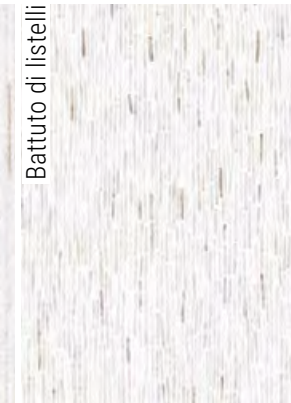

Seminato di tessere



CALACATTA GOLD CANOVA



Doghe

Battuto di listelli

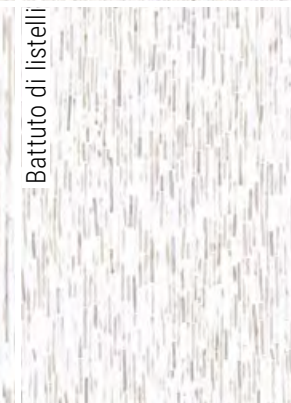

Seminato di tessere



FOSSIL BROWN MALEVIC



Doghe

Battuto di listelli

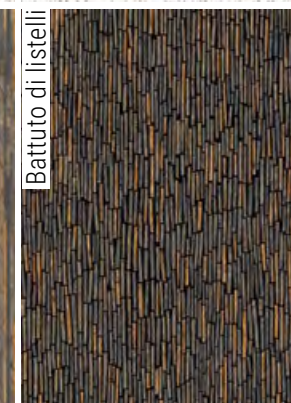

Seminato di tessere



ONICE KLIMT

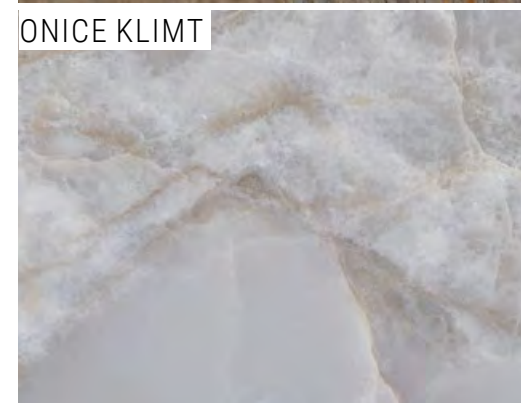

Doghe

Battuto di listelli

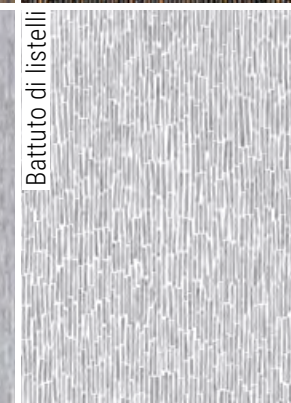

Seminato di tessere



MARFIL ORDÓÑEZ

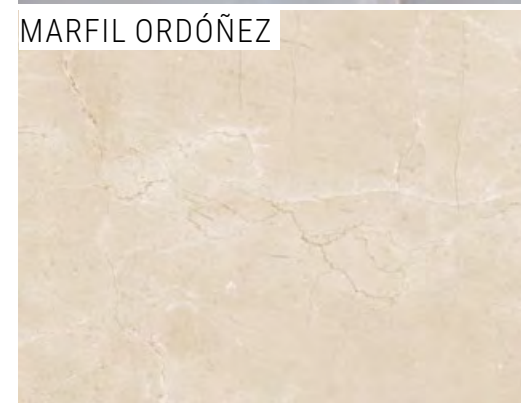

Doghe

Battuto di listelli



Seminato di tessere



TELE DI MARMO RELOADED

COLORI E FORMATI

Colours and Sizes | Couleurs et Formats | Farben und Formate | Colores y Tamaños | Цвета и Форматы

Quarzo Kandinsky



Doghe



Battuto di listelli



Seminato di tessere



Si consiglia la posa con fuga 2 mm. - Laying with a 2 mm-joint is recommended. - Pose recommandée avec joints de 2 mm.
Es wird eine Fugenbreite von 2 mm empfohlen. - Se recomienda la colocación con juntas de 2 mm. - Рекомендуется укладка с швом 2 мм.

TELE DI MARMO RELOADED

COLORI E FORMATI

Colours and Sizes | Couleurs et Formats | Farben und Formate | Colores y Tamaños | Цвета и Форматы

6,5 mm.

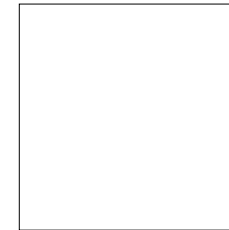
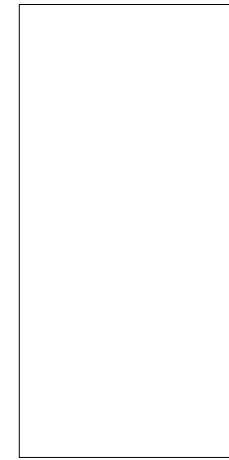

Full Lappato Rett.

120x240 - 47^{1/4}"x94^{1/2}"

E04N Quarzo Kandinsky ● 93

Doghe Full Lappato Rett.

120x240 - 47^{1/4}"x94^{1/2}"

E05U Quarzo Kandinsky ● 93

Battuto di listelli Full Lapp. Rett.

120x240 - 47^{1/4}"x94^{1/2}"

E05G Quarzo Kandinsky ● 93

Seminato di tessere Full Lapp. Rett.

120x240 - 47^{1/4}"x94^{1/2}"

E053 Quarzo Kandinsky ● 93

Full Lappato Rett.

120x120 - 47^{1/4}"x47^{1/4}"

E04U Quarzo Kandinsky ● 91

Doghe Full Lappato Rett.

120x120 - 47^{1/4}"x47^{1/4}"

E060 Quarzo Kandinsky ● 91

Battuto di listelli Full Lapp. Rett.

120x120 - 47^{1/4}"x47^{1/4}"

E05N Quarzo Kandinsky ● 91

Seminato di tessere Full Lapp. Rett.

120x120 - 47^{1/4}"x47^{1/4}"

E059 Quarzo Kandinsky ● 91

10 mm.



Naturale Rett.

60x120 - 23^{5/8}"x47^{1/4}"

E0EQ Quarzo Kandinsky ● 771

Full Lappato Rett.

60x120 - 23^{5/8}"x47^{1/4}"

E0E5 Quarzo Kandinsky ● 83

Doghe Full Lappato Rett.

60x120 - 23^{5/8}"x47^{1/4}"

E0FM Quarzo Kandinsky ● 83

Battuto di listelli Full Lapp. Rett.

60x120 - 23^{5/8}"x47^{1/4}"

E0FF Quarzo Kandinsky ● 83

Seminato di tessere Full Lapp. Rett.

60x120 - 23^{5/8}"x47^{1/4}"

E0F8 Quarzo Kandinsky ● 83

Full Lappato Rett.

90x90 - 35^{7/16}"x35^{7/16}"

E0EJ Quarzo Kandinsky ● 86

Full Lappato Rett.

30x60 - 11^{13/16}"x23^{5/8}"

E0EC Quarzo Kandinsky ● 78

Naturale Rett.

30x60 - 11^{13/16}"x23^{5/8}"

E0EW Quarzo Kandinsky ● 61

Naturale Rett.

7,5x30 - 2^{15/16}"x11^{13/16}"

E0F2 Quarzo Kandinsky ● 81

Si consiglia la posa con fuga 2 mm. - Laying with a 2 mm-joint is recommended. - Pose recommandée avec joints de 2 mm.
Es wird eine Fugenbreite von 2 mm empfohlen. - Se recomienda la colocación con juntas de 2 mm. - Рекомендуется укладка с швом 2 мм.

TELE DI MARMO RELOADED

COLORI E FORMATI

Colours and Sizes | Couleurs et Formats | Farben und Formate | Colores y Tamaños | Цвета и Форматы

Calacatta Gold Canova



Doghe



Battuto di listelli



Seminato di tessere

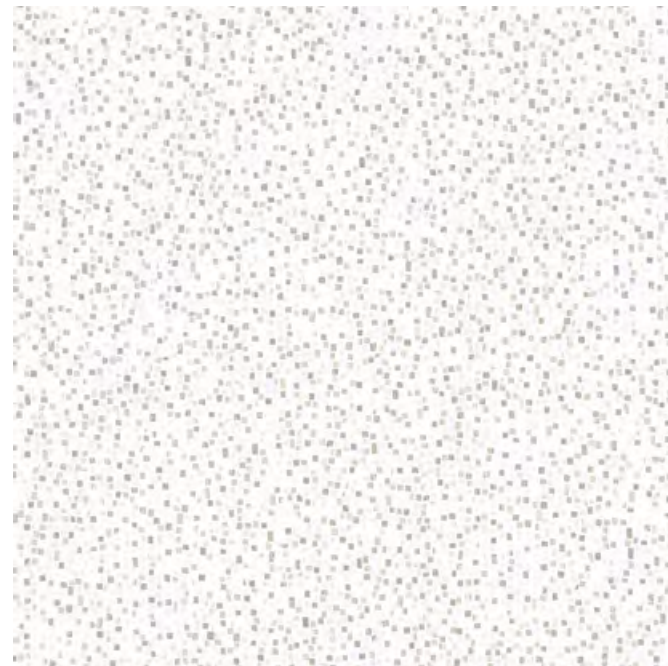

Si consiglia la posa con fuga 2 mm. - Laying with a 2 mm-joint is recommended. - Pose recommandée avec joints de 2 mm.
Es wird eine Fugenbreite von 2 mm empfohlen. - Se recomienda la colocación con juntas de 2 mm. - Рекомендуется укладка с швом 2 мм.

TELE DI MARMO RELOADED

COLORI E FORMATI

Colours and Sizes | Couleurs et Formats | Farben und Formate | Colores y Tamaños | Цвета и Форматы

6,5 mm.

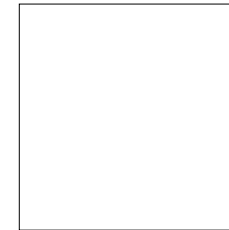
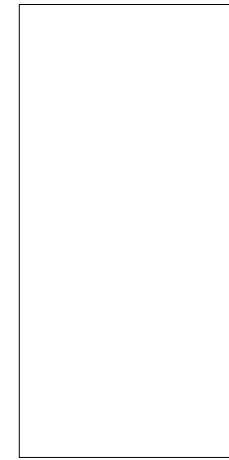

Full Lappato Rett.

120x240 - 47^{1/4}"x94^{1/2}"

E04P Calacatta Gold C. ● 93

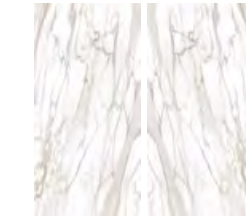

E066 Calacatta Gold C. Book Match A ● 93

E067 Calacatta Gold C. Book Match B ● 93

Full Lappato Rett.

120x120 - 47^{1/4}"x47^{1/4}"

E04V Calacatta Gold C. ● 91

Doghe Full Lappato Rett.

120x240 - 47^{1/4}"x94^{1/2}"

E05V Calacatta Gold Canova ● 93

Battuto di listelli Full Lapp. Rett.

120x240 - 47^{1/4}"x94^{1/2}"

E05H Calacatta Gold Canova ● 93

Seminato di tessere Full Lapp. Rett.

120x240 - 47^{1/4}"x94^{1/2}"

E054 Calacatta Gold Canova ● 93

Doghe Full Lappato Rett.

120x120 - 47^{1/4}"x47^{1/4}"

E061 Calacatta Gold Canova ● 91

Battuto di listelli Full Lapp. Rett.

120x120 - 47^{1/4}"x47^{1/4}"

E05P Calacatta Gold Canova ● 91

Seminato di tessere Full Lapp. Rett.

120x120 - 47^{1/4}"x47^{1/4}"

E05A Calacatta Gold Canova ● 91

10 mm.



Naturale Rett.

60x120 - 23^{5/8}"x47^{1/4}"

E0ER Calacatta Gold C. ● 771

Full Lappato Rett.

60x120 - 23^{5/8}"x47^{1/4}"

E0E6 Calacatta Gold C. ● 83

Doghe Full Lappato Rett.

60x120 - 23^{5/8}"x47^{1/4}"

E0FN Calacatta Gold Canova ● 83

Battuto di listelli Full Lapp. Rett.

60x120 - 23^{5/8}"x47^{1/4}"

E0FG Calacatta Gold Canova ● 83

Seminato di tessere Full Lapp. Rett.

60x120 - 23^{5/8}"x47^{1/4}"

E0F9 Calacatta Gold Canova ● 83



Full Lappato Rett.

90x90 - 35^{7/16}"x35^{7/16}"

E0EK Calacatta Gold C. ● 86



Naturale Rett.

30x60 - 11^{13/16}"x23^{5/8}"

E0EX Calacatta Gold C. ● 61

Full Lappato Rett.

30x60 - 11^{13/16}"x23^{5/8}"

E0ED Calacatta Gold C. ● 78



Naturale Rett.

7,5x30 - 2^{15/16}"x11^{13/16}"

E0F3 Calacatta Gold C. ● 81

Si consiglia la posa con fuga 2 mm. - Laying with a 2 mm-joint is recommended. - Pose recommandée avec joints de 2 mm.
Es wird eine Fugenbreite von 2 mm empfohlen. - Se recomienda la colocación con juntas de 2 mm. - Рекомендуется укладка с швом 2 мм.

TELE DI MARMO RELOADED

COLORI E FORMATI

Colours and Sizes | Couleurs et Formats | Farben und Formate | Colores y Tamaños | Цвета и Форматы

Fossil Brown Malevic



Doghe



Battuto di listelli



Seminato di tessere



TELE DI MARMO RELOADED

COLORI E FORMATI

Colours and Sizes | Couleurs et Formats | Farben und Formate | Colores y Tamaños | Цвета и Форматы

6,5 mm.

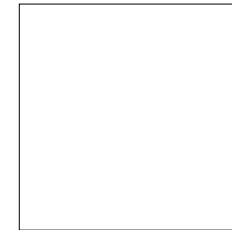
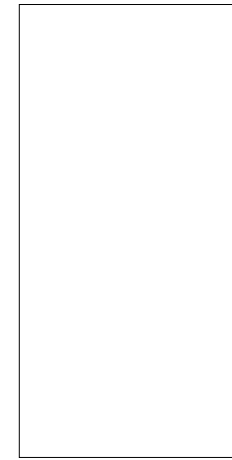

Full Lappato Rett.

120x240 - 47^{1/4}"x94^{1/2}"

E04Q Fossil Brown Mal. ● 93

Doghe Full Lappato Rett.

120x240 - 47^{1/4}"x94^{1/2}"

E05W Fossil Brown Malevic ● 93

Battuto di listelli Full Lapp. Rett.

120x240 - 47^{1/4}"x94^{1/2}"

E05J Fossil Brown Malevic ● 93

Seminato di tessere Full Lapp. Rett.

120x240 - 47^{1/4}"x94^{1/2}"

E055 Fossil Brown Malevic ● 93

Full Lappato Rett.

120x120 - 47^{1/4}"x47^{1/4}"

E04W Fossil Brown Mal. ● 91

Doghe Full Lappato Rett.

120x120 - 47^{1/4}"x47^{1/4}"

E062 Fossil Brown Malevic ● 91

Battuto di listelli Full Lapp. Rett.

120x120 - 47^{1/4}"x47^{1/4}"

E05Q Fossil Brown Malevic ● 91

Seminato di tessere Full Lapp. Rett.

120x120 - 47^{1/4}"x47^{1/4}"

E05C Fossil Brown Malevic ● 91

10 mm.

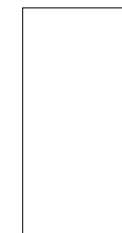

Naturale Rett.

60x120 - 23^{5/8}"x47^{1/4}"

E0ES Fossil Brown Mal. ● 771

Full Lappato Rett.

60x120 - 23^{5/8}"x47^{1/4}"

E0E7 Fossil Brown Mal. ● 83

Doghe Full Lappato Rett.

60x120 - 23^{5/8}"x47^{1/4}"

E0FP Fossil Brown Malevic ● 83

Battuto di listelli Full Lapp. Rett.

60x120 - 23^{5/8}"x47^{1/4}"

E0FH Fossil Brown Malevic ● 83

Seminato di tessere Full Lapp. Rett.

60x120 - 23^{5/8}"x47^{1/4}"

E0FA Fossil Brown Malevic ● 83

Full Lappato Rett.

90x90 - 35^{7/16}"x35^{7/16}"

E0EL Fossil Brown Mal. ● 86

Full Lappato Rett.

30x60 - 11^{13/16}"x23^{5/8}"

E0EE Fossil Brown Mal. ● 78

Naturale Rett.

30x60 - 11^{13/16}"x23^{5/8}"

E0EY Fossil Brown Mal. ● 61

Naturale Rett.

7,5x30 - 2^{15/16}"x11^{13/16}"

E0F4 Fossil Brown Mal. ● 81

Si consiglia la posa con fuga 2 mm. - Laying with a 2 mm-joint is recommended. - Pose recommandée avec joints de 2 mm. - Es wird eine Fugenbreite von 2 mm empfohlen. - Se recomienda la colocación con juntas de 2 mm. - Рекомендуются укладка с швом 2 мм.

TELE DI MARMO RELOADED

COLORI E FORMATI

Colours and Sizes | Couleurs et Formats | Farben und Formate | Colores y Tamaños | Цвета и Форматы

Onice Klimt



Doghe



Battuto di listelli

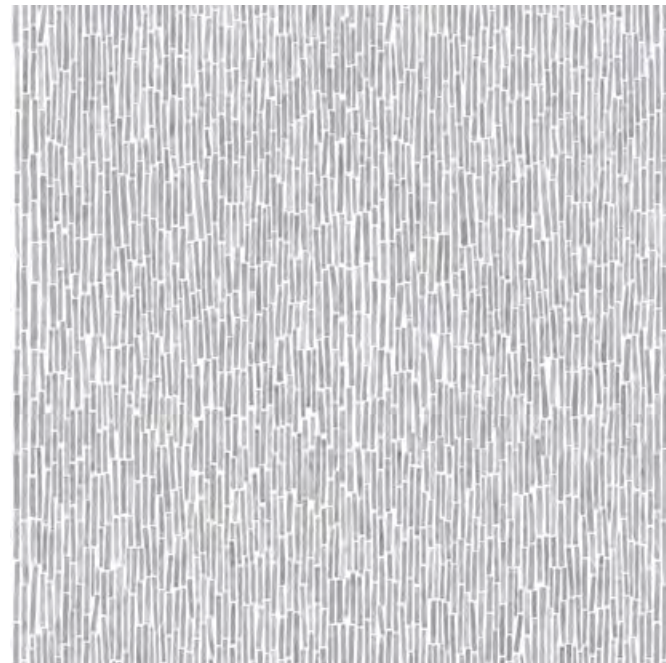

Seminato di tessere

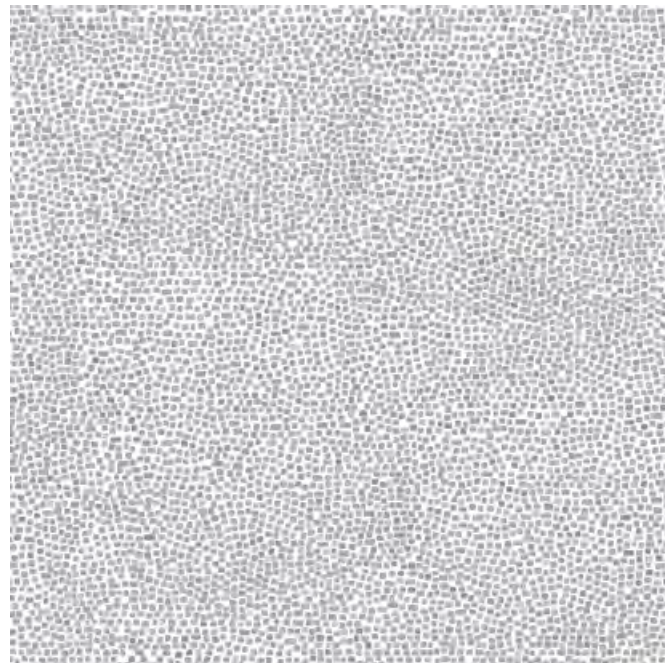

TELE DI MARMO RELOADED

COLORI E FORMATI

Colours and Sizes | Couleurs et Formats | Farben und Formate | Colores y Tamaños | Цвета и Форматы

6,5 mm.

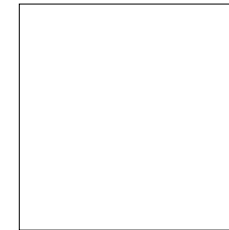
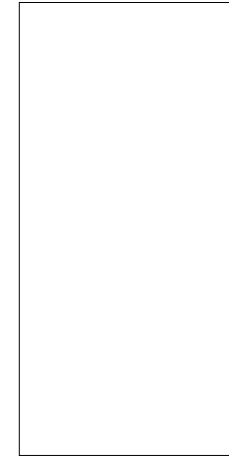

Full Lappato Rett.
120x240 - 47^{1/4}"x94^{1/2}"
E04R Onice Klimt

● 93

Doghe Full Lappato Rett.
120x240 - 47^{1/4}"x94^{1/2}"

E05X Onice Klimt

● 93

Battuto di listelli Full Lapp. Rett.

120x240 - 47^{1/4}"x94^{1/2}"

E05K Onice Klimt

● 93

Seminato di tessere Full Lapp. Rett.

120x240 - 47^{1/4}"x94^{1/2}"

E056 Onice Klimt

● 93

Full Lappato Rett.
120x120 - 47^{1/4}"x47^{1/4}"
E04X Onice Klimt

● 91

Doghe Full Lappato Rett.

120x120 - 47^{1/4}"x47^{1/4}"

E063 Onice Klimt

● 91

Battuto di listelli Full Lapp. Rett.

120x120 - 47^{1/4}"x47^{1/4}"

E05R Onice Klimt

● 91

Seminato di tessere Full Lapp. Rett.

120x120 - 47^{1/4}"x47^{1/4}"

E05D Onice Klimt

● 91

10 mm.

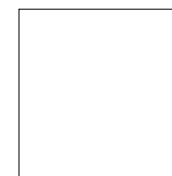

Naturale Rett.
60x120 - 23^{5/8}"x47^{1/4}"
E0ET Onice Klimt

● 771

Full Lappato Rett.
60x120 - 23^{5/8}"x47^{1/4}"
E0E8 Onice Klimt

● 83

Doghe Full Lappato Rett.

60x120 - 23^{5/8}"x47^{1/4}"

E0FQ Onice Klimt

● 83

Battuto di listelli Full Lapp. Rett.

60x120 - 23^{5/8}"x47^{1/4}"

E0FJ Onice Klimt

● 83

Seminato di tessere Full Lapp. Rett.

60x120 - 23^{5/8}"x47^{1/4}"

E0FC Onice Klimt

● 83

Full Lappato Rett.
90x90 - 35^{7/16}"x35^{7/16}"
E0EM Onice Klimt

● 86

Full Lappato Rett.
30x60 - 11^{13/16}"x23^{5/8}"
E0EF Onice Klimt

● 78

Naturale Rett.
30x60 - 11^{13/16}"x23^{5/8}"
E0EZ Onice Klimt

● 61

Naturale Rett.
7,5x30 - 2^{15/16}"x11^{13/16}"
E0F5 Onice Klimt

● 81

Si consiglia la posa con fuga 2 mm. - Laying with a 2 mm-joint is recommended. - Pose recommandée avec joints de 2 mm.
Es wird eine Fugenbreite von 2 mm empfohlen. - Se recomienda la colocación con juntas de 2 mm. - Рекомендуются укладка с швом 2 мм.

TELE DI MARMO RELOADED

COLORI E FORMATI

Colours and Sizes | Couleurs et Formats | Farben und Formate | Colores y Tamaños | Цвета и Форматы

Marfil Ordóñez



Doghe



Battuto di listelli



Seminato di tessere



TELE DI MARMO RELOADED

COLORI E FORMATI

Colours and Sizes | Couleurs et Formats | Farben und Formate | Colores y Tamaños | Цвета и Форматы

6,5 mm.

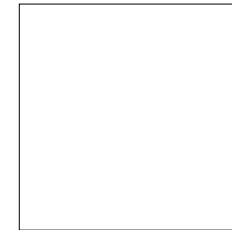
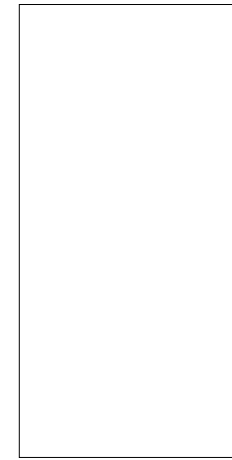

Full Lappato Rett.
120x240 - 47^{1/4}"x94^{1/2}"
E04S Marfil Ordóñez ● 93

Doghe Full Lappato Rett.
120x240 - 47^{1/4}"x94^{1/2}"
E05Y Marfil Ordóñez ● 93

Battuto di listelli Full Lapp. Rett.
120x240 - 47^{1/4}"x94^{1/2}"
E05L Marfil Ordóñez ● 93

Seminato di tessere Full Lapp. Rett.
120x240 - 47^{1/4}"x94^{1/2}"
E057 Marfil Ordóñez ● 93

Full Lappato Rett.
120x120 - 47^{1/4}"x47^{1/4}"
E04Y Marfil Ordóñez ● 91

Doghe Full Lappato Rett.
120x120 - 47^{1/4}"x47^{1/4}"
E064 Marfil Ordóñez ● 91

Battuto di listelli Full Lapp. Rett.
120x120 - 47^{1/4}"x47^{1/4}"
E05S Marfil Ordóñez ● 91

Seminato di tessere Full Lapp. Rett.
120x120 - 47^{1/4}"x47^{1/4}"
E05E Marfil Ordóñez ● 91

10 mm.

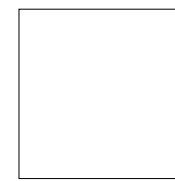
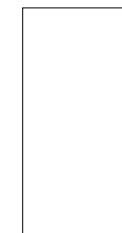

Naturale Rett.
60x120 - 23^{5/8}"x47^{1/4}"
E0EU Marfil Ordóñez ● 771

Full Lappato Rett.
60x120 - 23^{5/8}"x47^{1/4}"
E0E9 Marfil Ordóñez ● 83

Doghe Full Lappato Rett.
60x120 - 23^{5/8}"x47^{1/4}"
E0FR Marfil Ordóñez ● 83

Battuto di listelli Full Lapp. Rett.
60x120 - 23^{5/8}"x47^{1/4}"
E0FK Marfil Ordóñez ● 83

Seminato di tessere Full Lapp. Rett.
60x120 - 23^{5/8}"x47^{1/4}"
E0FD Marfil Ordóñez ● 83

Full Lappato Rett.
90x90 - 35^{7/16}"x35^{7/16}"
E0EN Marfil Ordóñez ● 86

Full Lappato Rett.
30x60 - 11^{13/16}"x23^{5/8}"
E0EG Marfil Ordóñez ● 78

Naturale Rett.
30x60 - 11^{13/16}"x23^{5/8}"
E0F0 Marfil Ordóñez ● 61

Naturale Rett.
7,5x30 - 2^{15/16}"x11^{13/16}"
E0F6 Marfil Ordóñez ● 81

Si consiglia la posa con fuga 2 mm. - Laying with a 2 mm-joint is recommended. - Pose recommandée avec joints de 2 mm.
Es wird eine Fugenbreite von 2 mm empfohlen. - Se recomienda la colocación con juntas de 2 mm. - Рекомендуются укладка с швом 2 мм.

TELE DI MARMO RELOADED

DECORI

Decors | Decors | Dekore | Decorados | Декоры

INTRECCI*



30x30 - 11^{13/16}"x11^{13/16}"

EOR3 Quarzo Kandinsky Nat. ● 100
EOR3 Quarzo Kandinsky Full Lapp. ● 1011



30x30 - 11^{13/16}"x11^{13/16}"

EQY Calacatta Gold Canova Nat. ● 100
EQY4 Calacatta Gold Canova Full Lapp. ● 1011



30x30 - 11^{13/16}"x11^{13/16}"

EQZ Fossil Brown Malevic Nat. ● 100
EQZ5 Fossil Brown Malevic Full Lapp. ● 1011



30x30 - 11^{13/16}"x11^{13/16}"

EOR0 Onice Klimt Nat. ● 100
EOR6 Onice Klimt Full Lapp. ● 1011



30x30 - 11^{13/16}"x11^{13/16}"

EOR1 Marfil Ordóñez Nat. ● 100
EOR7 Marfil Ordóñez Full Lapp. ● 1011

TELE DI MARMO RELOADED

DECORI

Decors | Decors | Dekore | Decorados | Декоры

MOSAICO 3X3*

Tessera - Chip 2,8x2,8 - 1^{1/8}"x1^{1/8}"



30x30 - 11^{13/16}"x11^{13/16}"

EQK Quarzo Kandinsky Nat. ● 98
EQR Quarzo Kandinsky Full Lapp. ● 101



30x30 - 11^{13/16}"x11^{13/16}"

EQL Calacatta Gold Canova Nat. ● 98
EQS Calacatta Gold Canova Full Lapp. ● 101



30x30 - 11^{13/16}"x11^{13/16}"

EQM Fossil Brown Malevic Nat. ● 98
EQT Fossil Brown Malevic Full Lapp. ● 101

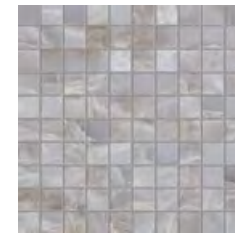

30x30 - 11^{13/16}"x11^{13/16}"

EQN Onice Klimt Nat. ● 98
EQU Onice Klimt Full Lapp. ● 101

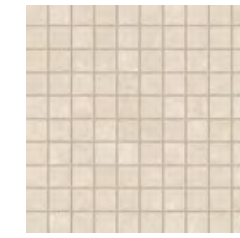

30x30 - 11^{13/16}"x11^{13/16}"

EQP Marfil Ordóñez Nat. ● 98
EQV Marfil Ordóñez Full Lapp. ● 101

MOSAICO 5X5*

Tessera - Chip 4,8x4,8 - 1^{7/8}"x1^{7/8}"

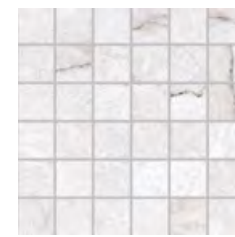

30x30 - 11^{13/16}"x11^{13/16}"

EQ5 Quarzo Kandinsky Nat. ● 93
EQD Quarzo Kandinsky Full Lapp. ● 96



30x30 - 11^{13/16}"x11^{13/16}"

EQ6 Calacatta Gold Canova Nat. ● 93
EQE Calacatta Gold Canova Full Lapp. ● 96

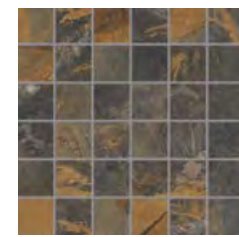

30x30 - 11^{13/16}"x11^{13/16}"

EQ7 Fossil Brown Malevic Nat. ● 93
EQF Fossil Brown Malevic Full Lapp. ● 96

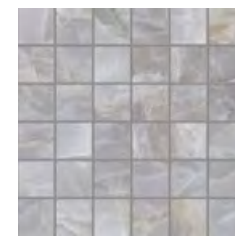

30x30 - 11^{13/16}"x11^{13/16}"

EQ8 Onice Klimt Nat. ● 93
EQG Onice Klimt Full Lapp. ● 96

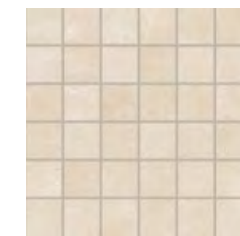

30x30 - 11^{13/16}"x11^{13/16}"

EQA Marfil Ordóñez Nat. ● 93
EQH Marfil Ordóñez Full Lapp. ● 96





* Su rete in fibra - On fibre mesh backing - Sur filet en fibre de verre - Auf Glasfasernetz - Sobre malla de fibra - На волоконной сетке

* Su rete in fibra - On fibre mesh backing - Sur filet en fibre de verre - Auf Glasfasernetz - Sobre malla de fibra - На волоконной сетке

TELE DI MARMO RELOADED

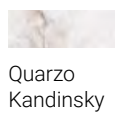
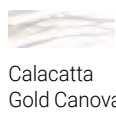
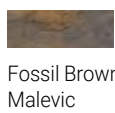
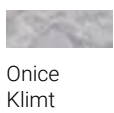
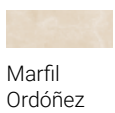
PEZZI SPECIALI

Trims | Pieces Speciales | Formteile | Piezas Especiales | Специальные Изделия

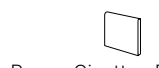
	Dimensione Size	 Quarzo Kandinsky	 Calacatta Gold Canova	 Fossil Brown Malevic	 Onice Klimt	 Marfil Ordóñez	Fascia di prezzo Price band
 Battiscopa - Skirting	Nat. Rett. 7x60 - 2 ^{3/4} x23 ^{5/8} " Pcs. Box 14 - LM x Box 8,40	E0R9	E0RA	E0RC	E0RD	E0RF	● 11
	Full Lapp. Rett. 7x60 - 2 ^{3/4} x23 ^{5/8} " Pcs. Box 14 - LM x Box 8,40	E0RH	E0RJ	E0RK	E0RL	E0RM	● 16
	Full Lapp. Rett. 4,6x90 - 1 ^{13/16} x35 ^{7/16} " Pcs. Box 8 - LM x Box 7,20	E0RP	E0RQ	E0RR	E0RS	E0RT	● 20
 Gradone - Step	Nat. Rett. 33x120x3,2x3,2 12 ^{15/16} x47 ^{1/4} x1 ^{1/4} x1 ^{1/4} " Pcs. Box 2 - LM x Box 2,40	E0RV	E0RW	E0RX	E0RY	E0RZ	● 95
	Full Lapp. Rett. 33x120x3,2x3,2 12 ^{15/16} x47 ^{1/4} x1 ^{1/4} x1 ^{1/4} " Pcs. Box 2 - LM x Box 2,40	E0S1	E0S2	E0S3	E0S4	E0S5	● 97
 Angolare Dx Sx Corner Tile Dx Sx	Nat. Rett. 33x120x3,2x3,2 12 ^{15/16} x47 ^{1/4} x1 ^{1/4} x1 ^{1/4} " Pcs. Box 1 - LM x Box 1,20	DX E0S7	DX E0S8	DX E0S9	DX E0SA	DX E0SC	● 100
	Full Lapp. Rett. 33x120x3,2x3,2 12 ^{15/16} x47 ^{1/4} x1 ^{1/4} x1 ^{1/4} " Pcs. Box 1 - LM x Box 1,20	SX E0SE	SX E0SF	SX E0SG	SX E0SH	SX E0SJ	
 Becco Civetta - Bullnose	Nat. Rett. 15x15 - 5 ^{7/8} x5 ^{7/8} " Pcs. Box 16	E0SY	E0SZ	E0T0	E0T1	E0T2	● 14
	Nat. Rett. 15x15 - 5 ^{7/8} x5 ^{7/8} " Pcs. Box 4	E0T4	E0T5	E0T6	E0T7	E0T8	● 26



TELE DI MARMO RELOADED

IMBALLI E PESI

Packing and Weight | Emballages et Poids | Verpackung und Gewicht | Embalajes y Pesos | Упаковка и Вес

Formato Size Format Format Tamaño Формат cm	Spessore Thickness Epaisseur Stärke Espesor Толщина mm	Pz. x Mq. Pieces x Sqm Pcs / M ² Stk. x Qm Pzs x Mc. Шт x Кв.М.	Pz. x Scat. Pieces x Box Pcs / Bte Stk. x Krt. Pzs x Caja Шт x Кор.	Mq. x Scat. Sqm x Box M ² / Bte Qm x Krt. Mc. x Caja Кв.М. x Кор.	Peso x Scat. Weight x Box Poids / Bte Gewicht x Krt. Peso x Caja Вес x Кор. Kg	Scat. x Pal. Boxes x Pal. Bte / Pal. Krt. x Pal. Cajas x Pal. Кор. x Подд.	Mq. x Pal. Sqm x Pal. M ² / Pal. Qm x Pal. Mc. x Pal. Кв.М x Подд.	Peso x Pal. Weight x Pal. Poids / Pal. Gewicht x Pal. Peso x Pal. Вес x Подд. Kg
120x240 Full Lappato	6,5	0,35	1	2,880	44,00			
120x120 Full Lappato	6,5	0,69	1	1,440	22			vedi sotto - see below
60X120 Nat. - Full Lappato	10	1,39	2	1,440	33,19	36	51,84	1195
90x90 Full Lappato	10	1,26	2	1,584	37,5	24	38,02	900
30x60 Nat. - Full Lappato	10	5,56	6	1,080	24,52	40	43,20	981
7,5x30 Naturale	10	44,44	36	0,810	12,18	56	45,36	682
30x30 Mosaico 5X5 Nat. - Full Lappato	10	11,11	5	0,450	10,66	60	27	640
30x30 Mosaico 3X3 Nat. - Full Lappato	10	11,11	5	0,450	10,82	60	27	649
30x30 Intrecci Nat. - Full Lappato	10	11,11	5	0,450	10,66	60	27	640

Slabs 120x120 - 120x240

Articolo Item Reference Artikel Articulo Артикула	Dimensione (cm) Size (cm) Format (cm) Format (cm) Тamaño (cm) Формат (cm)	Nr. Lastre No. of Slabs Nbre Dalles Anz. Platten Nº de Placas Кол. Плит	Mq. x Imballo sqm per Pack m ² / Emballage qm pro Verpackung m ² por embalaje Кв.м. x упаковку	Peso Imballo (Kg) Weight of Packaging (kg) Poids Emballage (kg) Gewicht Verpackung (kg) Peso embalaje (kg) Вес упаковки (кг)	Peso Imballo+Lastre (Kg) Weight of Packaging + Slabs (kg) Poids Emballage+Dalles (kg) Gewicht Verpackung+Platten (kg) Peso embalaje + placas (kg) Вес упаковки + плит (кг)
 120x120 Cassa - Crate - Caisse Kiste - Caja - Ящик	139x139x41h	24	35,56	62,5	613,3
 120x240 Cassa - Crate - Caisse Kiste - Caja - Ящик	136x266x41h	20	57,60	99	1020,6
 120x240 Cavalletto - A-Frame Chevalet de transport - Transportgestell Caballete - Подставка	75x250x160h	40	115,20	163	2006,2

TELE DI *Marmi* REVOLUTION

FORMATI

Sizes | Formats | Formate | Tamaños | Форматы

6,5 mm.

120x278 - 47^{1/4}"x109^{7/16}" Full Lappato

10 mm.

90x90 - 35^{7/16}"x35^{7/16}" Full Lappato

60x120 - 23^{5/8}"x47^{1/4}" Naturale - Full Lappato

30x60 - 11^{13/16}"x23^{5/8}" Naturale - Full Lappato

SUPERFICI

Finishes | Finitions | Oberflächen
Superficies | Отделка поверхности

NATURALE

R9 DIN 51130

A DIN 51097

Wet \geq 0,42 ANSI A 137.1- 2012 DCOF (Section 9.6)

\geq 0,40 B.C.R.A.

- AS 4586: 2013

- BS 7976-2: 2002

- ENV 12633-2006

FULL LAPPATO

- DIN 51130

- DIN 51097

- ANSI A 137.1- 2012 DCOF (Section 9.6)

- B.C.R.A.

- AS 4586: 2013

- BS 7976-2: 2002

- ENV 12633-2006

SHADE VARIATIONS



V3 HIGH

DESTINAZIONI D'USO

Intended uses | Domaines d'application
Zweckbestimmung | Usos previstos | Назначение



Min. 7,5%



BLU ANDE



Acanto



THASSOS

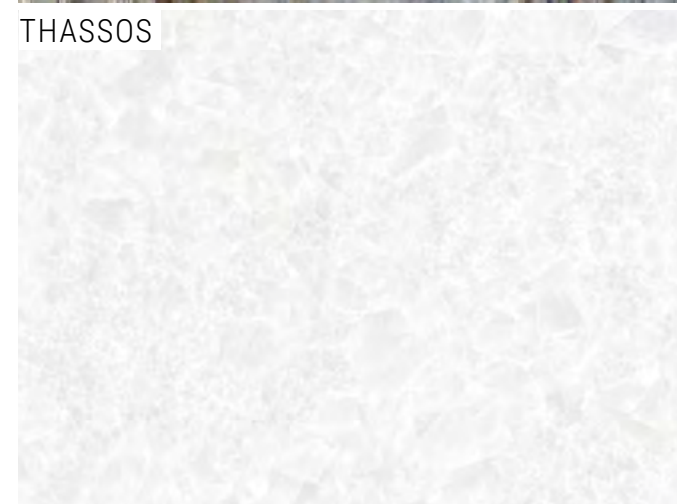

Acanto

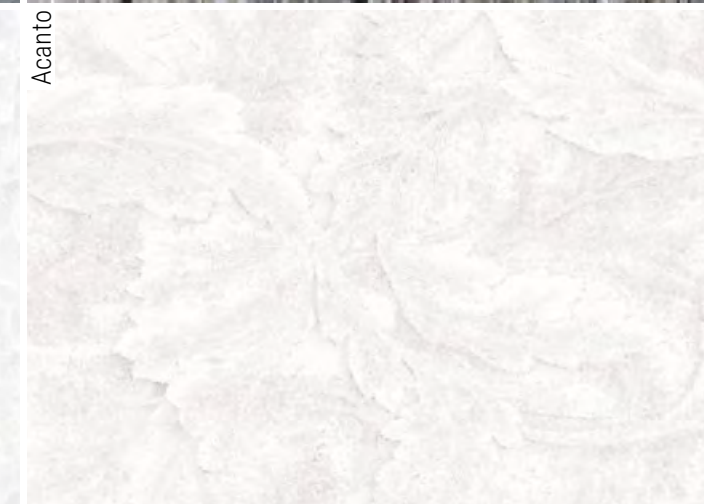

VERDE SAINT DENIS



Acanto



CALACATTA BLACK

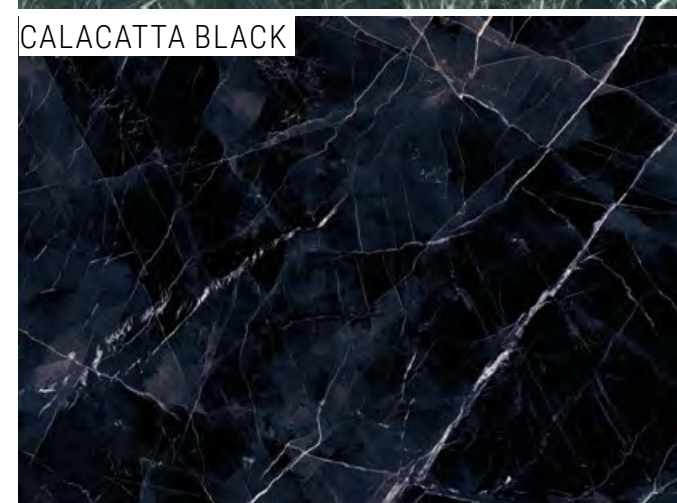

Acanto



TELE DI MARMO REVOLUTION

COLORI E FORMATI

Colours and Sizes | Couleurs et Formats | Farben und Formate | Colores y Tamaños | Цвета и Форматы

Blu Ande



Blu Ande Acanto



Thassos

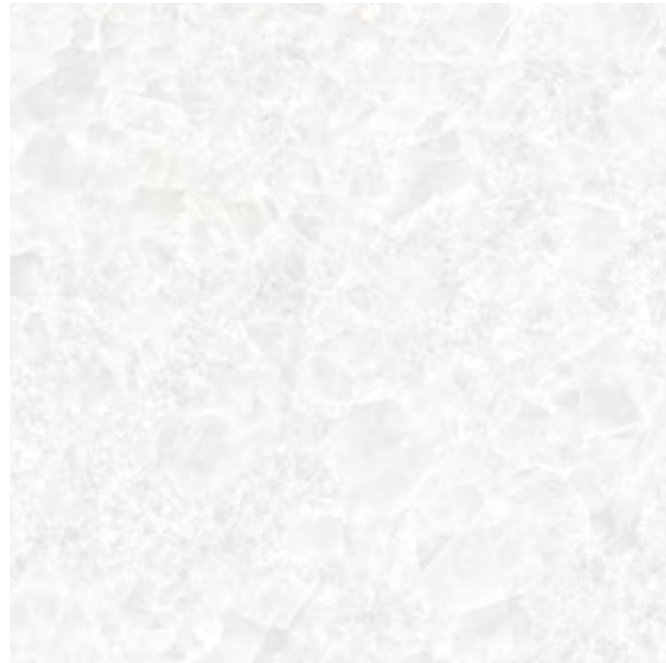

Thassos Acanto



TELE DI MARMO REVOLUTION

COLORI E FORMATI

Colours and Sizes | Couleurs et Formats | Farben und Formate | Colores y Tamaños | Цвета и Форматы

6,5 mm.

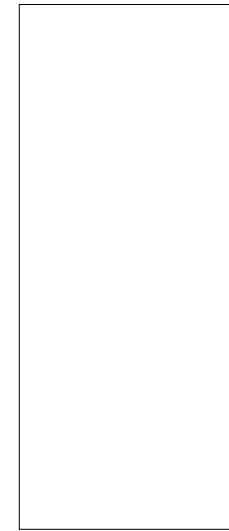

Full Lappato Rett.
120x278 - 47^{1/4}"x109^{7/16}"
EHA3 Blu Ande ● 94
EHA2 Thassos ● 94

Acanto Full Lappato Rett.
120x278 - 47^{1/4}"x109^{7/16}"
EHAQ Blu Ande ● 94
EHAP Thassos ● 94

10 mm.



Naturale Rett.
60x120 - 23^{5/8}"x47^{1/4}"
EHC0 Blu Ande ● 771
EHAZ Thassos ● 771

Full Lappato Rett.
60x120 - 23^{5/8}"x47^{1/4}"
EHA8 Blu Ande ● 83
EHA7 Thassos ● 83

Acanto Full Lappato Rett.
60x120 - 23^{5/8}"x47^{1/4}"
EHAV Blu Ande ● 83
EHAU Thassos ● 83

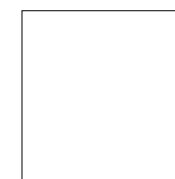

Full Lappato Rett.
90x90 - 35^{7/16}"x35^{7/16}"
EHAE Blu Ande ● 86
EHAD Thassos ● 86



Naturale Rett.
30x60 - 11^{13/16}"x23^{5/8}"
EHC5 Blu Ande ● 61
EHC4 Thassos ● 61

Full Lappato Rett.
30x60 - 11^{13/16}"x23^{5/8}"
EHAJ Blu Ande ● 78
EHAJ Thassos ● 78

Si consiglia la posa con fuga 2 mm. - Laying with a 2 mm-joint is recommended. - Pose recommandée avec joints de 2 mm.
Es wird eine Fugenbreite von 2 mm empfohlen. - Se recomienda la colocación con juntas de 2 mm. - Рекомендуется укладка с швом 2 мм.

TELE DI MARMO REVOLUTION

COLORI E FORMATI

Colours and Sizes | Couleurs et Formats | Farben und Formate | Colores y Tamaños | Цвета и Форматы

Verde Saint Denis

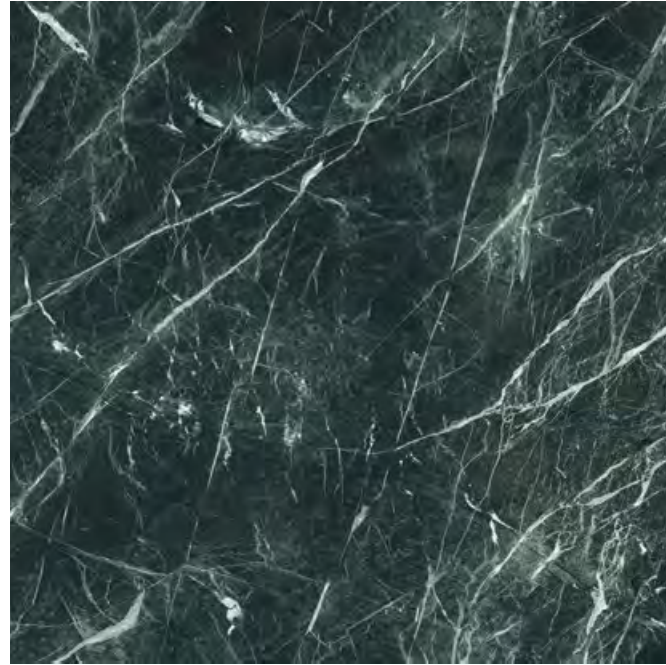

Verde Saint Denis Acanto

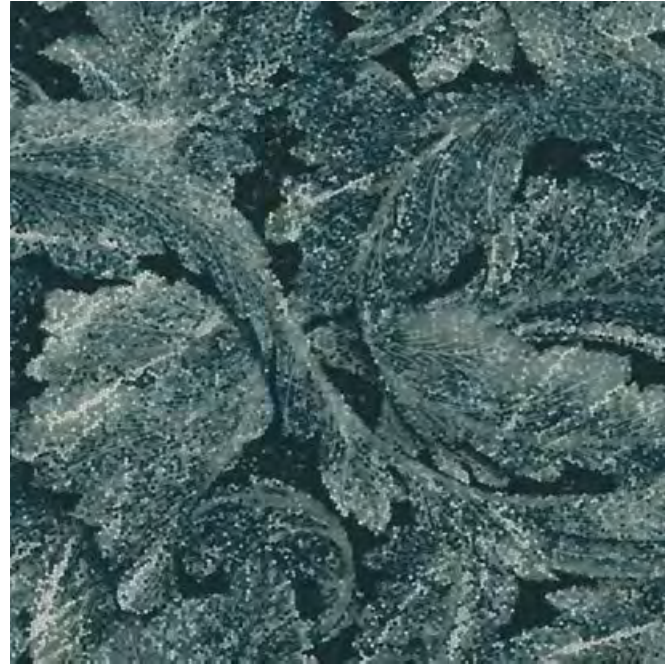

Calacatta Black



Calacatta Black Acanto

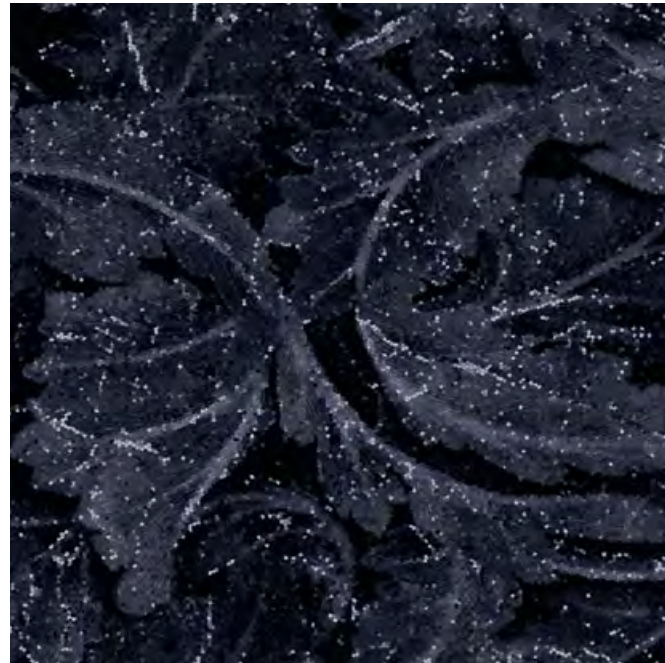

Si consiglia la posa con fuga 2 mm. - Laying with a 2 mm-joint is recommended. - Pose recommandée avec joints de 2 mm.
Es wird eine Fugenbreite von 2 mm empfohlen. - Se recomienda la colocación con juntas de 2 mm. - Рекомендуется укладка с швом 2 мм.

TELE DI MARMO REVOLUTION

COLORI E FORMATI

Colours and Sizes | Couleurs et Formats | Farben und Formate | Colores y Tamaños | Цвета и Форматы

6,5 mm.

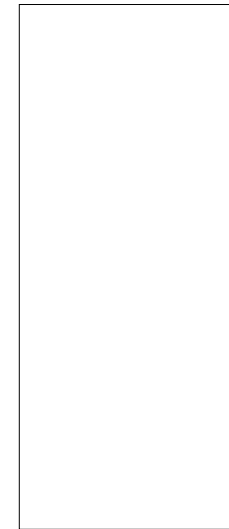

Full Lappato Rett.
120x278 - 47^{1/4}"x109^{7/16}"
EHA4 Verde Saint Denis ● 94
EHA5 Calacatta Black ● 94

Acanto Full Lappato Rett.
120x278 - 47^{1/4}"x109^{7/16}"
EHAR Verde Saint Denis ● 94
EHAS Calacatta Black ● 94

10 mm.



Naturale Rett.
60x120 - 23^{5/8}"x47^{1/4}"
EHC1 Verde Saint Denis ● 771
EHC2 Calacatta Black ● 771

Full Lappato Rett.
60x120 - 23^{5/8}"x47^{1/4}"
EHA9 Verde Saint Denis ● 83
EHA4 Calacatta Black ● 83

Acanto Full Lappato Rett.
60x120 - 23^{5/8}"x47^{1/4}"
EHAW Verde Saint Denis ● 83
EHAX Calacatta Black ● 83

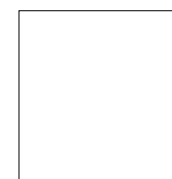

Full Lappato Rett.
90x90 - 35^{7/16}"x35^{7/16}"
EHA6 Verde Saint Denis ● 86
EHA7 Calacatta Black ● 86



Naturale Rett.
30x60 - 11^{13/16}"x23^{5/8}"
EHC6 Verde Saint Denis ● 61
EHC7 Calacatta Black ● 61

Full Lappato Rett.
30x60 - 11^{13/16}"x23^{5/8}"
EHAL Verde Saint Denis ● 78
EHAM Calacatta Black ● 78

Si consiglia la posa con fuga 2 mm. - Laying with a 2 mm-joint is recommended. - Pose recommandée avec joints de 2 mm.
Es wird eine Fugenbreite von 2 mm empfohlen. - Se recomienda la colocación con juntas de 2 mm. - Рекомендуется укладка с швом 2 мм.

TELE DI MARMO REVOLUTION

DECORI

Decors | Decors | Dekore | Decorados | Декоры

INTRECCI*



30x30 - 11^{13/16}"x11^{13/16}"

EHPH

Blu Ande Nat.

● 100



30x30 - 11^{13/16}"x11^{13/16}"

EHPG

Thassos Nat.

● 100

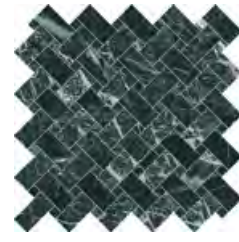

30x30 - 11^{13/16}"x11^{13/16}"

EHPJ Verde

Saint Denis Nat.

● 100

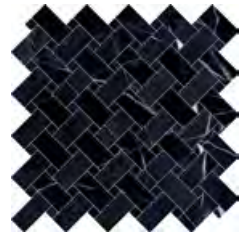

30x30 - 11^{13/16}"x11^{13/16}"

EHPK Calacatta

Black Nat.

● 100

EHPN

Blu Ande Full Lapp.

● 1011

EHPM

Thassos Full Lapp.

● 1011

EHPV Verde

Saint Denis Full Lapp.

● 1011

EHPQ Calacatta

Black Full Lapp.

● 1011

MOSAICO 3X3*

Tessera - Chip 2,8x2,8 - 1^{1/8}"x1^{1/8}"



30x30 - 11^{13/16}"x11^{13/16}"

EHP6

Blu Ande Nat.

● 98

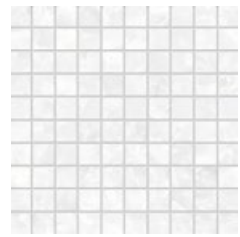

30x30 - 11^{13/16}"x11^{13/16}"

EHP5

Thassos Nat.

● 98

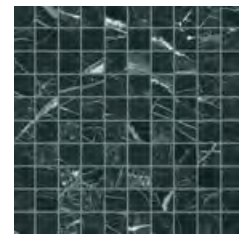

30x30 - 11^{13/16}"x11^{13/16}"

EHP7 Verde

Saint Denis Nat.

● 98

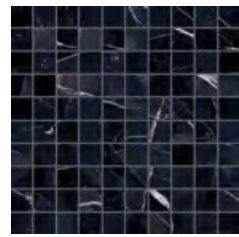

30x30 - 11^{13/16}"x11^{13/16}"

EHP8 Calacatta

Black Nat.

● 98

EHPC

Blu Ande Full Lapp.

● 101

EHPA

Thassos Full Lapp.

● 101

EHPD Verde

Saint Denis Full Lapp.

● 101

EHPE Calacatta

Black Full Lapp.

● 101

MOSAICO 5X5*

Tessera - Chip 4,8x4,8 - 1^{7/8}"x1^{7/8}"



30x30 - 11^{13/16}"x11^{13/16}"

EHNW

Blu Ande Nat.

● 93



30x30 - 11^{13/16}"x11^{13/16}"

EHNV

Thassos Nat.

● 93

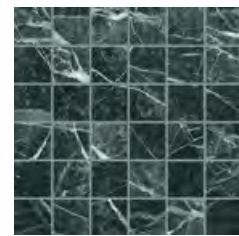

30x30 - 11^{13/16}"x11^{13/16}"

EHNX Verde

Saint Denis Nat.

● 93

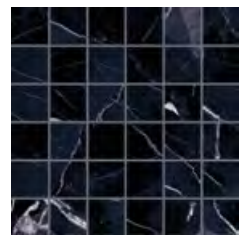

30x30 - 11^{13/16}"x11^{13/16}"

EHNH Calacatta

Black Nat.

● 93

EHP1

Blu Ande Full Lapp.

● 96

EHP0

Thassos Full Lapp.

● 96

EHP2 Verde

Saint Denis Full Lapp.

● 96

EHP3 Calacatta

Black Full Lapp.







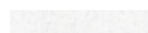

● 96

* Su rete in fibra - On fibre mesh backing - Sur filet en fibre de verre - Auf Glasfasernetz - Sobre malla de fibra - На волоконной сетке

TELE DI MARMO REVOLUTION

PEZZI SPECIALI

Trims | Pieces Speciales | Formteile | Piezas Especiales | Специальные Изделия



	Dimensione Size	 Blu Ande	 Thassos	 Verde St. Denis	 Calacatta Black	Fascia di prezzo Price band				
	Nat. Rett. 7x60 - 2 ^{3/4} "x23 ^{5/8} " Pcs. Box 14 - LM x Box 8,40	EHPT	EHPS	EHPV	EHPW	● 11				
	Full Lapp. Rett. 7x60 - 2 ^{3/4} "x23 ^{5/8} " Pcs. Box 14 - LM x Box 8,40	EHPZ	EHPY	EHQ0	EHQ1	● 16				
	Full Lapp. Rett. 4,6x90 - 1 ^{13/16} "x35 ^{7/16} " Pcs. Box 8 - LM x Box 7,20	EHQ4	EHQ3	EHQ5	EHQ6	● 20				
	Nat. Rett. 33x120x3,2x3,2 12 ^{15/16} "x47 ^{1/4} "x1 ^{1/4} "x1 ^{1/4} " Pcs. Box 2 - LM x Box 2,40	EHQA	EHQ9	EHQC	EHQD	● 95				
	Full Lapp. Rett. 33x120x3,2x3,2 12 ^{15/16} "x47 ^{1/4} "x1 ^{1/4} "x1 ^{1/4} " Pcs. Box 2 - LM x Box 2,40	EHQG	EHQF	EHQH	EHQJ	● 97				
	Nat. Rett. 33x120x3,2x3,2 12 ^{15/16} "x47 ^{1/4} "x1 ^{1/4} "x1 ^{1/4} " Pcs. Box 1 - LM x Box 1,20	DX EHQM	SX EHQS	DX EHQL	SX EHQR	DX EHQN	SX EHQT	DX EHQP	SX EHQU	● 100
	Full Lapp. Rett. 33x120x3,2x3,2 12 ^{15/16} "x47 ^{1/4} "x1 ^{1/4} "x1 ^{1/4} " Pcs. Box 1 - LM x Box 1,20	DX EHQX	SX EHR2	DX EHQW	SX EHR1	DX EHQY	SX EHR3	DX EHQZ	SX EHR4	● 101
	Nat. Rett. 15x15 - 5 ^{7/8} "x5 ^{7/8} " Pcs. Box 16	EHR7	EHR6	EHR8	EHR9	● 14				
	Nat. Rett. 15x15 - 5 ^{7/8} "x5 ^{7/8} " Pcs. Box 4	EHRD	EHRC	EHRE	EHRF	● 26				

IMBALLI E PESI

Packing and Weight | Emballages et Poids | Verpackung und Gewicht | Embalajes y Pesos | Упаковка и Вес

Formato Size Format Format Tamaño Формат cm	Spessore Thickness Epaisseur Stärke Espesor Толщина mm	Pz. x Mq. Pieces x Sqm Pcs / M ² Stk. x Qm Pzs x Mc. Шт x Кв.М.	Pz. x Scat. Pieces x Box Pcs / Bte Stk. x Krt. Pzs x Caja Шт x Кор.	Mq. x Scat. Sqm x Box M ² / Bte Qm x Krt. Mc. x Caja Кв.М. x Кор.	Peso x Scat. Weight x Box Poids / Bte Gewicht x Krt. Peso x Caja Вес x Кор. Kg	Scat. x Pal. Boxes x Pal. M ² / Pal. Krt. x Pal. Cajas x Pal. Кор. x Подд.	Mq. x Pal. Sqm x Pal. M ² / Pal. Qm x Pal. Mc. x Pal. Кв.М x Подд.	Peso x Pal. Weight x Pal. Poids / Pal. Gewicht x Pal. Peso x Pal. Вес x Подд. Kg
120x278 Full Lappato - Decoro Acanto	6,5	0,30	1	3,336	53			vedi sotto - see below
60x120 Naturale - Full Lappato	10	1,39	2	1,440	36,2	36	51,84	1303
90x90 Full Lappato	10	1,23	2	1,620	36,81	24	38,88	883
60x120 Decoro Acanto	10	1,39	2	1,440	35,85	36	51,84	1291
30x60 Naturale - Full Lappato	10	5,56	6	1,080	24,00	40	43,20	960
30x30 Mosaico 5X5 Nat. - Full Lappato	10	11,11	5	0,450	10,5	60	27,00	630
30x30 Mosaico 3X3 Nat. - Full Lappato	10	11,11	5	0,450	10,5	60	27,00	630
30x30 Mos. Intrecci Nat. - Full Lappato	10	11,11	5	0,450	10,5	60	27,00	630

Slabs 120x278

Articolo Item Reference Artikel Articulo Артикула	Dimensione (cm) Size (cm) Format (cm) Format (cm) Tamaño (cm) Формат (cm)	Nr. Lastre No. of Slabs Nbre Dalles Anz. Platten Nº de Placas Кол. Плит	Mq. x Imballo sqm per Pack m ² / Emballage qm pro Verpackung m ² por embalaje Кв.м. x упаковку	Peso Imballo (Kg) Weight of Packaging (kg) Poids Emballage (kg) Gewicht Verpackung (kg) Peso embalaje (kg) Вес упаковки (кг)	Peso Imballo+Lastre (Kg) Weight of Packaging + Slabs (kg) Weight of Packaging+Dalles (kg) Gewicht Verpackung+Platten (kg) Peso embalaje + placas (kg) Вес упаковки + плит (кг)
 120x278	140x291x41h	18	60,05	120	1201
 120x278	75x288x160h	40	133,44	180	2582

TOTALOOK

TECNICA

Premium Technical Feature

Nella versione Tecnica la superficie è particolarmente antiscivolo, tanto da renderla perfetta per spazi esterni, pubblici e privati. In the Tecnica version, the surface has outstanding anti-slip properties, making it perfect for public and private outdoor areas.

FORMATI

Sizes | Formats | Formate | Tamaños | Форматы

6,5 mm.

120x120 - 47^{1/4}"x47^{1/4}" Naturale

60x120 - 23^{5/8}"x47^{1/4}" Naturale

10 mm.

80x80 - 31^{1/2}"x31^{1/2}" Soft - Tecnica

40x80 - 15^{3/4}"x31^{1/2}" Soft

60x60 - 23^{5/8}"x23^{5/8}" Soft

30x60 - 11^{13/16}"x23^{5/8}" Soft

6x24 - 2^{3/8}"x9^{7/16}" Majolica

20MM

80x80 - 31^{1/2}"x31^{1/2}" Naturale

60x60 - 23^{5/8}"x23^{5/8}" Naturale

SUPERFICI

Finishes | Finitions | Oberflächen
Superficies | Отделка поверхности

SOFT | MAJOLICA MATT

R9 DIN 51130

- DIN 51097

Wet $\geq 0,42$ ANSI A 137.1- 2012 DCOF (Section 9.6)

$\geq 0,40$ B.C.R.A.

- AS 4586: 2013

- BS 7976-2: 2002

- ENV 12633-2006

NATURALE

R10 DIN 51130

B (A+B) DIN 51097

Wet $\geq 0,50$ ANSI A 137.1- 2012 DCOF (Section 9.6)

$\geq 0,40$ B.C.R.A.

P2 AS 4586: 2013

< 36 Moderate Slip potential BS 7976-2: 2002

- ENV 12633-2006

TECNICA | 20MM

R11 DIN 51130

C (A+B+C) DIN 51097

Wet $\geq 0,65$ ANSI A 137.1- 2012 DCOF (Section 9.6)

$\geq 0,40$ B.C.R.A.

P4 AS 4586: 2013

> 36 Low Slip potential BS 7976-2: 2002

3 ENV 12633-2006

SHADE VARIATIONS



DESTINAZIONI D'USO

Intended uses | Domaines d'application
Zweckbestimmung | Usos previstos | Назначение



BLU AVIO



SABBIA

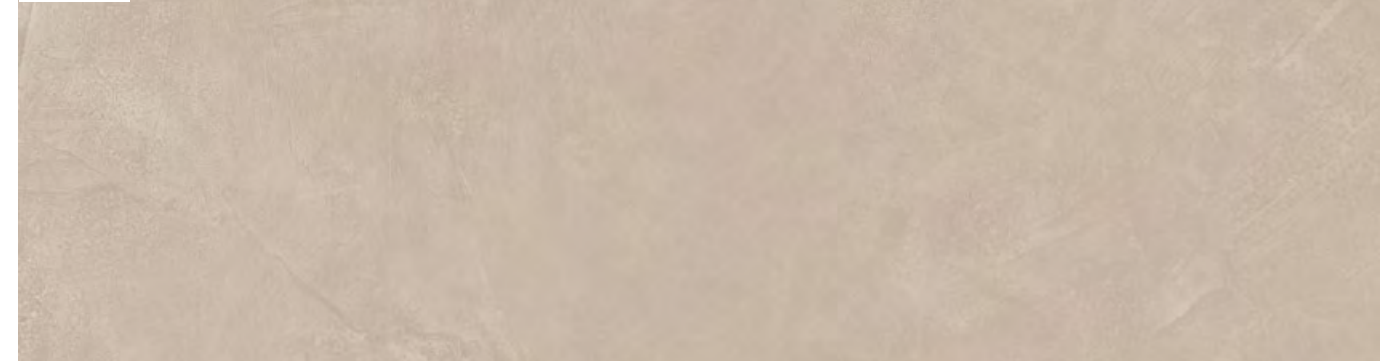

BIANCO



GRIGIO



ANTRACITE



COLORI E FORMATI

Colours and Sizes | Couleurs et Formats | Farben und Formate | Colores y Tamaños | Цвета и Форматы

Blu Avio



Sabbia



Bianco



Grigio



Antracite



COLORI E FORMATI

Colours and Sizes | Couleurs et Formats | Farben und Formate | Colores y Tamaños | Цвета и Форматы

6,5 mm.

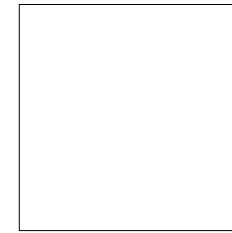

Naturale Rett.

120x120 - 47^{1/4}"x47^{1/4}"

- EHD4 Blu Avio ● 87
- EHD1 Sabbia ● 87
- EHD0 Bianco ● 87
- EHD2 Grigio ● 87
- EHD3 Antracite ● 87



Naturale Rett.

60x120 - 23^{5/8}"x47^{1/4}"

- EHDA Blu Avio ● 771
- EHD7 Sabbia ● 771
- EHD6 Bianco ● 771
- EHD8 Grigio ● 771
- EHD9 Antracite ● 771

10 mm.



Soft Rett.

80x80 - 31^{1/2}"x31^{1/2}"

- EHCE Blu Avio U₄P₃E₃C₂ ● 78
- EHCA Sabbia U₄P₃E₃C₂ ● 78
- EHC9 Bianco U₄P₃E₃C₂ ● 78
- EHCC Grigio U₄P₃E₃C₂ ● 78
- EHCD Antracite U₄P₃E₃C₂ ● 78



Soft Rett.

40x80 - 15^{3/4}"x31^{1/2}"

- EHCL Blu Avio U₄P₄E₃C₂ ● 74
- EHCH Sabbia U₄P₄E₃C₂ ● 74
- EHCG Bianco U₄P₄E₃C₂ ● 74
- EHCJ Grigio U₄P₄E₃C₂ ● 74
- EHCK Antracite U₄P₄E₃C₂ ● 74



Soft Rett.

60x60 - 23^{5/8}"x23^{5/8}"

- EHCS Blu Avio U₄P₄E₃C₂ ● 662
- EHCP Sabbia U₄P₄E₃C₂ ● 662
- EHCN Bianco U₄P₄E₃C₂ ● 662
- EHCQ Grigio U₄P₄E₃C₂ ● 662
- EHCR Antracite U₄P₄E₃C₂ ● 662



Soft Rett.

30x60 - 11^{13/16}"x23^{5/8}"

- EHCY Blu Avio U₄P₄E₃C₂ ● 61
- EHCV Sabbia U₄P₄E₃C₂ ● 61
- EHCU Bianco U₄P₄E₃C₂ ● 61
- EHCW Grigio U₄P₄E₃C₂ ● 61
- EHCX Antracite U₄P₄E₃C₂ ● 61

Tecnica Rett.

80x80 - 31^{1/2}"x31^{1/2}"

- EHF3 Blu Avio ● 78
- EHF0 Sabbia ● 78
- EHEZ Bianco ● 78
- EHF1 Grigio ● 78
- EHF2 Antracite ● 78

20MM

Naturale Rett.

80x80 - 31^{1/2}"x31^{1/2}"

- EHFA Grigio ● 87
- EHFC Antracite ● 87

Naturale Rett.

60x60 - 23^{5/8}"x23^{5/8}"

- EHV6 Grigio ● 83

Si consiglia la posa con fuga 2 mm. - Laying with a 2 mm-joint is recommended. - Pose recommandée avec joints de 2 mm.
Es wird eine Fugenbreite von 2 mm empfohlen. - Se recomienda la colocación con juntas de 2 mm. - Рекомендується укладка с швом 2 мм.

TOTALOOK

DECORI

Decors | Decors | Dekore | Decorados | Декоры

TOTASLIM

6,5 mm. SAGOMA*



30x30 - 11^{13/16}"x11^{13/16}"
EHWU Sagoma Nat. ● 103

6,5 mm. MOSAICO 3X3*

Tessera - Chip 2,8x2,8 - 1^{1/8}"x1^{1/8}"

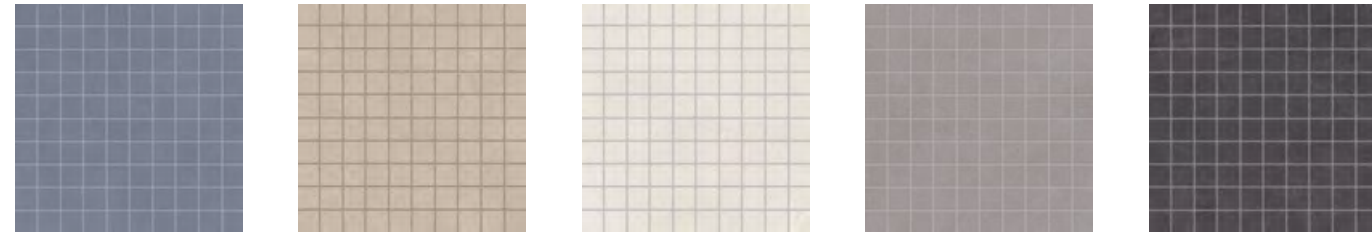

30x30 - 11^{13/16}"x11^{13/16}"
EHVR Blu Avio Nat. ● 101

30x30 - 11^{13/16}"x11^{13/16}"
EHVN Sabbia Nat. ● 101

30x30 - 11^{13/16}"x11^{13/16}"
EHVM Bianco Nat. ● 101

30x30 - 11^{13/16}"x11^{13/16}"
EHVP Grigio Nat. ● 101

30x30 - 11^{13/16}"x11^{13/16}"
EHVQ Antracite Nat. ● 101

6,5 mm. MOSAICO SEQUENZA*

Tessere 3,13x29,8 - 1^{1/4}"x11^{3/4}"



30x30 - 11^{13/16}"x11^{13/16}"
EHXZ Blu Avio Nat. ● 99

30x30 - 11^{13/16}"x11^{13/16}"
EHWQ Sabbia Nat. ● 99

30x30 - 11^{13/16}"x11^{13/16}"
EHWP Bianco Nat. ● 99

30x30 - 11^{13/16}"x11^{13/16}"
EHWR Grigio Nat. ● 99

30x30 - 11^{13/16}"x11^{13/16}"
EHWS Antracite Nat. ● 99

* Su rete in fibra - On fibre mesh backing - Sur filet en fibre de verre - Auf Glasfasernetz - Sobre malla de fibra - На волоконной сетке

TOTALOOK

DECORI

Decors | Decors | Dekore | Decorados | Декоры

TOTALBRICK

10 mm. MAJOLICA MATT



6x24 - 2^{3/8}"x9^{7/16}"
EH98 Blu Avio ● 60



6x24 - 2^{3/8}"x9^{7/16}"
EH95 Sabbia ● 60



6x24 - 2^{3/8}"x9^{7/16}"
EH94 Bianco ● 60



6x24 - 2^{3/8}"x9^{7/16}"
EH96 Grigio ● 60



6x24 - 2^{3/8}"x9^{7/16}"
EH97 Antracite ● 60

10 mm. MAJOLICA LUX



6x24 - 2^{3/8}"x9^{7/16}"
EH6H Blu Avio ● 64

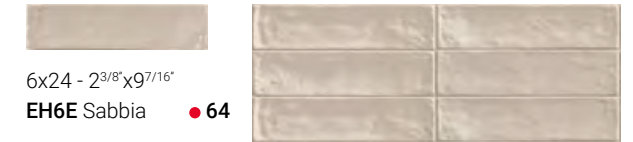

6x24 - 2^{3/8}"x9^{7/16}"
EH6E Sabbia ● 64

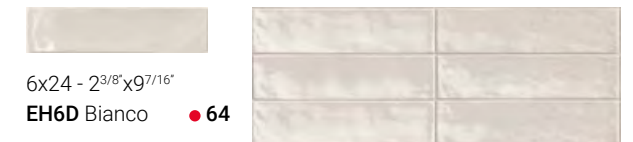

6x24 - 2^{3/8}"x9^{7/16}"
EH6D Bianco ● 64



6x24 - 2^{3/8}"x9^{7/16}"
EH6F Grigio ● 64



6x24 - 2^{3/8}"x9^{7/16}"
EH6G Antracite ● 64

TOTALOOK

DECORI

Decors | Decors | Dekore | Decorados | Декоры

10 mm. CUBO



20x20 - 7⁷/₈"x7⁷/₈"

EHEJ Cubo Nat. Rett. ● 85



10 mm. INCROCI

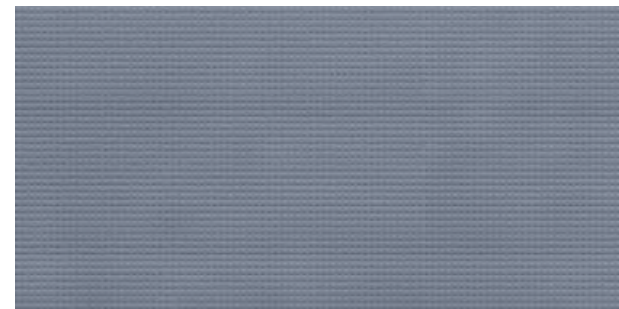

40x80 - 15³/₄"x31¹/₂"

EHJG Blu Avio Nat. Rett. ● 76

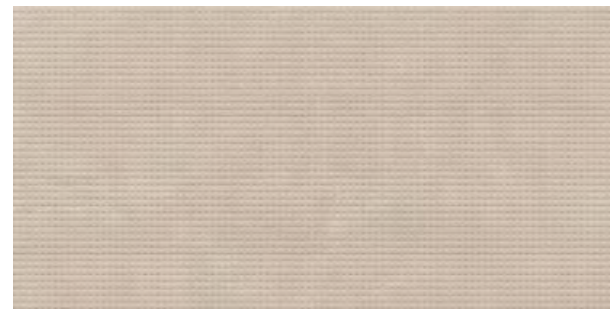

40x80 - 15³/₄"x31¹/₂"

EHJD Sabbia Nat. Rett. ● 76



40x80 - 15³/₄"x31¹/₂"

EHJC Bianco Nat. Rett. ● 76

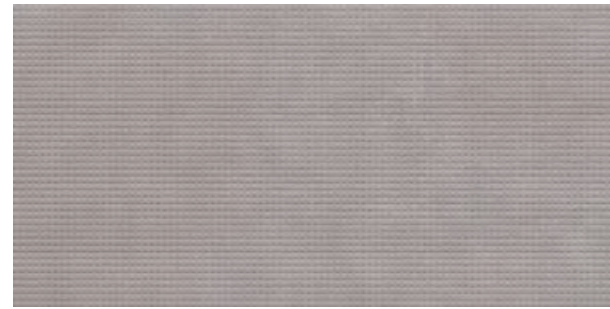

40x80 - 15³/₄"x31¹/₂"

EHJE Grigio Nat. Rett. ● 76

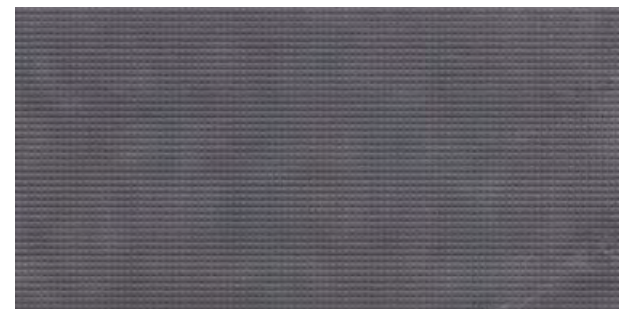

40x80 - 15³/₄"x31¹/₂"

EHJF Antracite Nat. Rett. ● 76

TOTALOOK

DECORI

Decors | Decors | Dekore | Decorados | Декоры

10 mm. DOLCELINEA



30x60 - 11¹³/₁₆"x23⁵/₈"

EHJN Blu Avio Nat. Rett. ● 63



30x60 - 11¹³/₁₆"x23⁵/₈"

EHJK Sabbia Nat. Rett. ● 63



30x60 - 11¹³/₁₆"x23⁵/₈"

EHJJ Bianco Nat. Rett. ● 63



30x60 - 11¹³/₁₆"x23⁵/₈"

EHJL Grigio Nat. Rett. ● 63



30x60 - 11¹³/₁₆"x23⁵/₈"

EHJM Antracite Nat. Rett. ● 63

10 mm. MOSAICO 3X3*

Tessera - Chip 2,8x2,8 - 1¹/₈"x1¹/₈"

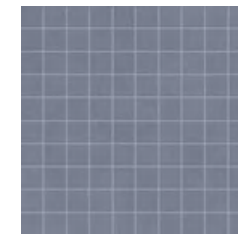

30x30 - 11¹³/₁₆"x11¹³/₁₆"

EHJU Blu Avio Nat. ● 96

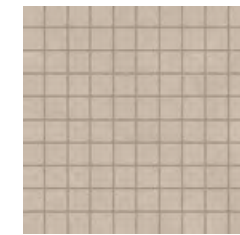

30x30 - 11¹³/₁₆"x11¹³/₁₆"

EHJR Sabbia Nat. ● 96



30x30 - 11¹³/₁₆"x11¹³/₁₆"

EHJQ Bianco Nat. ● 96

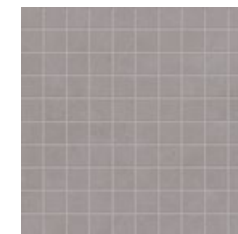

30x30 - 11¹³/₁₆"x11¹³/₁₆"

EHJS Grigio Nat. ● 96

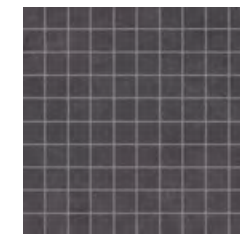





30x30 - 11¹³/₁₆"x11¹³/₁₆"

EHJT Antracite Nat. ● 96

* Su rete in fibra - On fibre mesh backing - Sur filet en fibre de verre
Auf Glasfasernetz - Sobre malla de fibra - На волоконной сетке

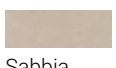
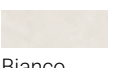
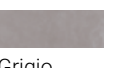
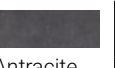
PEZZI SPECIALI

Trims | Pieces Speciales | Formteile | Piezas Especiales | Специальные Изделия

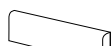
	Dimensione Size	 Blu Avio	 Sabbia	 Bianco	 Grigio	 Antracite	Fascia di prezzo Price band
 Battiscopa - Skirting	Nat. Rett. 7x60 - 2 ³ / ₄ x23 ⁵ / ₈ " Pcs. Box 14 - LM x Box 8,40	EHK0	EHJX	EHJW	EHJY	EHJZ	● 11
	Nat. Rett. 4,6x80 - 1 ¹³ / ₁₆ x31 ¹ / ₂ " Pcs. Box 12 - LM x Box 9,60	EHK6	EHK3	EHK2	EHK4	EHK5	● 16
 Gradino - Stair Tread	Nat. Rett. 33x60 - 12 ¹⁵ / ₁₆ x23 ⁵ / ₈ " Pcs. Box 6 - LM x Box 3,60	EHKD	EHK9	EHK8	EHKA	EHKC	● 61
 Gradone - Step	Nat. Rett. 33x60x3,2x3,2 12 ¹⁵ / ₁₆ x23 ⁵ / ₈ x1 ¹ / ₄ x1 ¹ / ₄ " Pcs. Box 4 - LM x Box 2,40	EHKK	EHKG	EHKF	EHKH	EHKJ	● 79
 Angolare Dx Sx Corner Tile Dx Sx	Nat. Rett. 33x60x3,2x3,2 - 12 ¹⁵ / ₁₆ x23 ⁵ / ₈ x1 ¹ / ₄ x1 ¹ / ₄ " Pcs. Box 2 - LM x Box 1,20	DX EHKR	DX EHKN	DX EHKM	DX EHKP	DX EHKQ	● 93
		SX EHKX	SX EHKU	SX EHKT	SX EHKV	SX EHKW	
 Becco Civetta - Bullnose	Matt 6x24 - 2 ³ / ₈ x9 ⁷ / ₁₆ " Pcs. Box 36	EHVK	EHVG	EHVF	EHVH	EHVJ	● 10
	Lux 6x24 - 2 ³ / ₈ x9 ⁷ / ₁₆ " Pcs. Box 36	EHVD	EHV9	EHV8	EHVA	EHVC	● 11

Pezzi speciali 20mm su richiesta
20mm trims available on request
pièces spéciales 20mm (sur demande)
formteile 20mm auf anfrage erhältlich
piezas especiales 20mm disponibles bajo pedido
Специальные изделия 20мм по запросу

IMBALLI E PESI

Packing and Weight | Emballages et Poids | Verpackung und Gewicht | Embalajes y Pesos | Упаковка и Вес

Formato Size Format Format Tamaño Формат cm	Spessore Thickness Epaisseur Stärke Espesor Толщина mm	Pz. x Mq. Pieces x Sqm Pcs / M ² Stk. x Qm Pzs x Mc. Шт x Кв.М.	Pz. x Scat. Pieces x Box Pcs / Bte Stk. x Krt. Pzs x Caja Шт x Кор.	Mq. x Scat. Sqm x Box M ² / Bte Qm x Krt. Mc. x Caja Кв.М. x Кор.	Peso x Scat. Weight x Box Poids / Bte Gewicht x Krt. Peso x Caja Вес x Кор. Kg	Scat. x Pal. Boxes x Pal. Bte / Pal. Krt. x Pal. Cajas x Pal. Кор. x Подд.	Mq. x Pal. Sqm x Pal. M ² / Pal. Qm x Pal. Mc. x Pal. Кв.М x Подд.	Peso x Pal. Weight x Pal. Poids / Pal. Gewicht x Pal. Peso x Pal. Вес x Подд. Kg
120x120 Natural	6,5	0,69	2	2,880	46	20	57,60	984
60x120 Natural	6,5	1,39	3	2,160	32	15	32,40	480
80x80 Soft - Tecnica	10	1,56	2	1,280	39,84	42	53,76	1673
80x80 20MM Naturale	20	1,56	1	0,640	30,47	45	28,80	1371
40x80 Soft - Incroci	10	3,13	3	0,960	22,33	28	26,88	625
60x60 Soft	10	2,78	3	1,080	24,11	40	43,20	964
60x60 20MM Naturale	20	2,78	2	0,720	32,46	32	23,04	1039
30x60 Soft - Dolcelinea	10	5,56	6	1,080	22,66	40	43,20	906
30x30 Mosaico 3X3	10	11,11	5	0,450	10,50	60	27,00	630
30x30 Mosaico 3X3	6,5	11,11	5	0,450	10,50	60	27,00	630
30x30 Mosaico Sequenza	6,5	11,11	5	0,450	10,50	60	27,00	630
30x30 Mosaico Sagoma	6,5	11,11	5	0,450	10,50	60	27,00	630
20x20 Cubo	10	25,00	18	0,720	16,20	72	51,84	1166
6x24 Majolica Lux - Matt	10	69,44	36	0,518	10,10	95	49,25	960



Sabbia Nat. Rett.
80x80 - 31¹/₂x31¹/₂"

Sabbia Nat. Rett.
40x80 - 15³/₄x31¹/₂"

Cubo
20x20 - 7⁷/₈x7⁷/₈"

TRACCE

FORMATI

Sizes | Formats | Formate | Tamaños | Форматы

9,5 mm.

60x60 - 23^{5/8}"x23^{5/8}" Naturale

30x60 - 11^{13/16}"x23^{5/8}" Naturale

SUPERFICI

Finishes | Finitions | Oberflächen
Superficies | Отделка поверхности

NATURALE

R10 DIN 51130

B (A+B) DIN 51097

Wet \geq 0,50 ANSI A 137.1- 2012 DCOF (Section 9.6)

\geq 0,40 B.C.R.A.

P2 AS 4586: 2013

< 36 Moderate Slip potential BS 7976-2: 2002

- ENV 12633-2006

SHADE VARIATIONS



V4 RANDOM

DESTINAZIONI D'USO

Intended uses | Domaines d'application
Zweckbestimmung | Usos previstos | Назначение



Min. 7,5%



IVORY



TAUPE



DENIM



GREY



DARK GREY

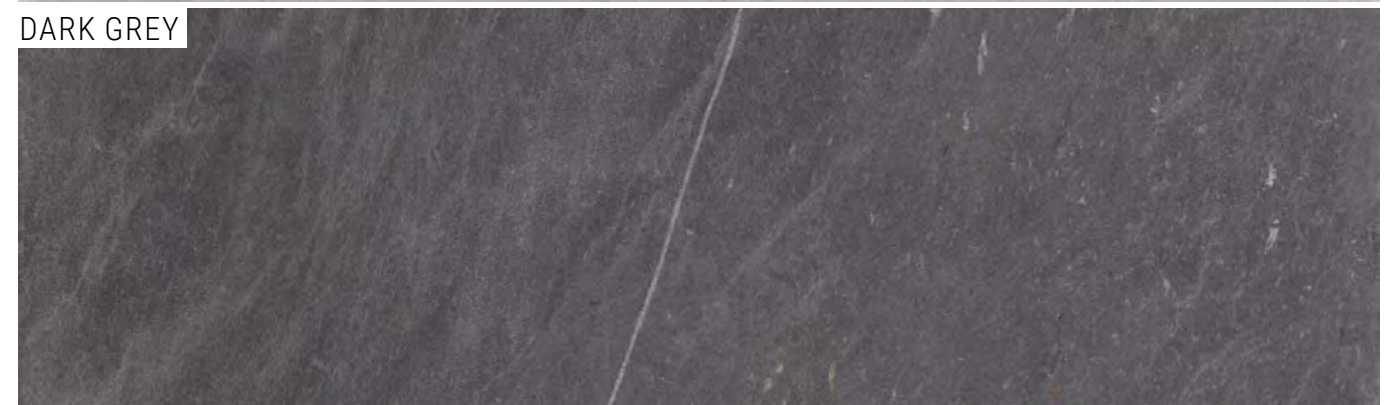

TRACCE

COLORI E FORMATI

Colours and Sizes | Couleurs et Formats | Farben und Formate | Colores y Tamaños | Цвета и Форматы

Ivory



Taupe



Denim



Grey



Dark Grey



TRACCE

COLORI E FORMATI

Colours and Sizes | Couleurs et Formats | Farben und Formate | Colores y Tamaños | Цвета и Форматы

9,5 mm.

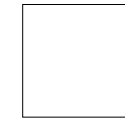

Naturale Rett.

60x60 - 23⁵/₈"x23⁵/₈"

- ECK7 Ivory ● 662
- ECK8 Taupe ● 662
- ECK9 Denim ● 662
- ECKA Grey ● 662
- ECKC Dark Grey ● 662

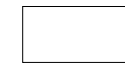

Naturale Rett.

30x60 - 11¹³/₁₆"x23⁵/₈"

- ECKD Ivory ● 61
- ECKF Taupe ● 61
- ECKH Denim ● 61
- ECKK Grey ● 61
- ECKM Dark Grey ● 61

TRACCE

DECORI

Decors | Decors | Dekore | Decorados | Декоры

DECORO RAIL 3D



30x60 - 11^{13/16}"x23^{5/8}"
ECKE Ivory Nat. Rett. ● 62



15x60 - 5^{7/8}"x23^{5/8}"
ECR2 Ivory Nat. Rett. ● 72



30x60 - 11^{13/16}"x23^{5/8}"
ECKG Taupe Nat. Rett. ● 62



15x60 - 5^{7/8}"x23^{5/8}"
ECR3 Taupe Nat. Rett. ● 72



30x60 - 11^{13/16}"x23^{5/8}"
ECKJ Denim Nat. Rett. ● 62

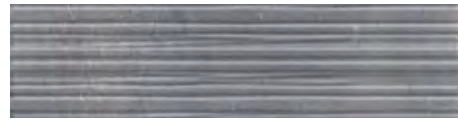

15x60 - 5^{7/8}"x23^{5/8}"
ECR4 Denim Nat. Rett. ● 72



30x60 - 11^{13/16}"x23^{5/8}"
ECKL Grey Nat. Rett. ● 62



15x60 - 5^{7/8}"x23^{5/8}"
ECR5 Grey Nat. Rett. ● 72

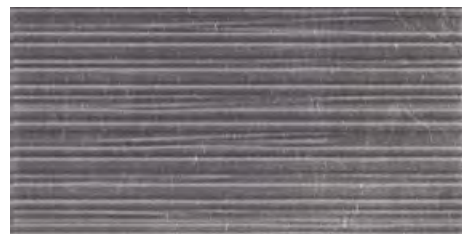

30x60 - 11^{13/16}"x23^{5/8}"
ECKN Dark Grey Nat. Rett. ● 62

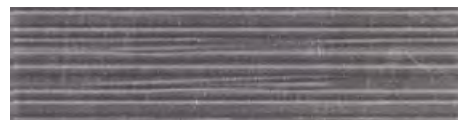

15x60 - 5^{7/8}"x23^{5/8}"
ECR6 Dark Grey Nat. Rett. ● 72

TRACCE

DECORI

Decors | Decors | Dekore | Decorados | Декоры

MOSAICO 5X5*

Tessera - Chip 4,8x4,8 - 1^{7/8}"x1^{7/8}"



30x30 - 11^{13/16}"x11^{13/16}"
ECNJ Ivory Nat. ● 93



30x30 - 11^{13/16}"x11^{13/16}"
ECNK Taupe Nat. ● 93

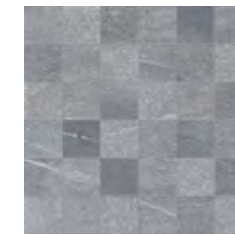

30x30 - 11^{13/16}"x11^{13/16}"
ECNL Denim Nat. ● 93

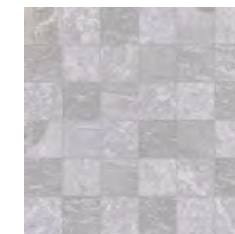

30x30 - 11^{13/16}"x11^{13/16}"
ECNM Grey Nat. ● 93



30x30 - 11^{13/16}"x11^{13/16}"
ECNN Dark Grey Nat. ● 93

MOSAICO DOMINO*

Tessera - Chip 2,3x4,8 - 7/8"x1^{7/8}"



30x30 - 11^{13/16}"x11^{13/16}"
ECRL Ivory Nat. ● 98



30x30 - 11^{13/16}"x11^{13/16}"
ECRM Taupe Nat. ● 98



30x30 - 11^{13/16}"x11^{13/16}"
ECRN Denim Nat. ● 98



30x30 - 11^{13/16}"x11^{13/16}"
ECRP Grey Nat. ● 98



30x30 - 11^{13/16}"x11^{13/16}"
ECRQ Dark Grey Nat. ● 98

MOSAICO ARROWS*



Chiusura mezza losanga
2,16x13,6 - 7/8"x5^{3/8}"
ECS0 Ivory Nat. ● 3
Pcs. Box 10

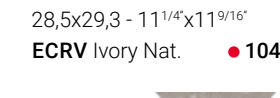

Chiusura triangolo
4,5x2,6 - 1^{3/4}"x1^{1/6}"
ECS5 Ivory Nat. ● 2
Pcs. Box 12



Chiusura mezza losanga
2,16x13,6 - 7/8"x5^{3/8}"
ECS1 Taupe Nat. ● 3
Pcs. Box 10

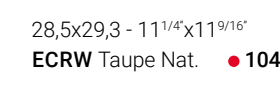

Chiusura triangolo
4,5x2,6 - 1^{3/4}"x1^{1/6}"
ECS6 Taupe Nat. ● 2
Pcs. Box 12

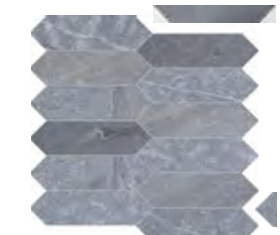

Chiusura mezza losanga
2,16x13,6 - 7/8"x5^{3/8}"
ECS2 Denim Nat. ● 3
Pcs. Box 10

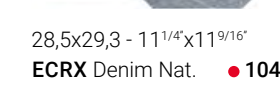

Chiusura triangolo
4,5x2,6 - 1^{3/4}"x1^{1/6}"
ECS7 Denim Nat. ● 2
Pcs. Box 12



Chiusura mezza losanga
2,16x13,6 - 7/8"x5^{3/8}"
ECS3 Grey Nat. ● 3
Pcs. Box 10

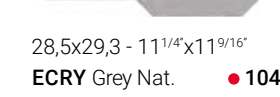

Chiusura triangolo
4,5x2,6 - 1^{3/4}"x1^{1/6}"
ECS8 Grey Nat. ● 2
Pcs. Box 12



Chiusura mezza losanga
2,16x13,6 - 7/8"x5^{3/8}"
ECS4 Dark Grey Nat. ● 3
Pcs. Box 10

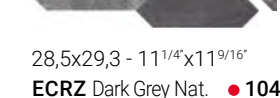





Chiusura triangolo
4,5x2,6 - 1^{3/4}"x1^{1/6}"
ECS9 Dark Grey Nat. ● 2
Pcs. Box 12

* Su rete in fibra - On fibre mesh backing - Sur filet en fibre de verre - Auf Glasfasernetz - Sobre malla de fibra - На волоконной сетке

PEZZI SPECIALI

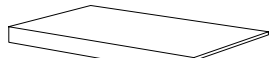
Trims | Pieces Speciales | Formteile | Piezas Especiales | Специальные Изделия

	Dimensione Size	Ivory	Taupe	Denim	Grey	Dark Grey	Fascia di prezzo Price band
 Battiscopa - Skirting	Nat. Rett. 7x60 - 2 ^{3/4} x23 ^{5/8} " Pcs. Box 14 - LM x Box 8,40	ECPG	ECPH	ECPJ	ECPK	ECPL	● 11
 Gradino - Stair Tread	Nat. Rett. 33x60 - 12 ^{15/16} x23 ^{5/8} " Pcs. Box 6 - LM x Box 3,60	ECP5	ECP6	ECP7	ECP8	ECP9	● 61
 Gradone - Step	Nat. Rett. 33x60x3,2x3,2 12 ^{15/16} x23 ^{5/8} x1 ^{1/4} x1 ^{1/4} " Pcs. Box 4 - LM x Box 2,40	ECNP	ECNQ	ECNR	ECNS	ECNT	● 79
 Angolare Dx Sx Corner Tile Dx Sx	Nat. Rett. 33x60x3,2x3,2 - 12 ^{15/16} x23 ^{5/8} x1 ^{1/4} x1 ^{1/4} " Pcs. Box 2 - LM x Box 1,20	DX ECNV	DX ECNX	DX ECNZ	DX ECP1	DX ECP3	● 93
		SX ECNW	SX ECNY	SX ECP0	SX ECP2	SX ECP4	

IMBALLI E PESI

Packing and Weight | Emballages et Poids | Verpackung und Gewicht | Embalajes y Pesos | Упаковка и Вес

Formato Size Format Format Тamaño Формат cm	Spessore Thickness Epaisseur Stärke Espesor Толщина mm	Pz. x Mq. Pieces x Sqm Pcs / M ² Stk. x Qm Pzs x Mc. Шт x Кв.М.	Pz. x Scat. Pieces x Box Pcs / Bte Stk. x Krt. Pzs x Caja Шт x Кор.	Mq. x Scat. Sqm x Box M ² / Bte Qm x Krt. Mc. x Caja Кв.М. x Кор.	Peso x Scat. Weight x Box Poids / Bte Gewicht x Krt. Peso x Caja Вес x Кор. Kg	Scat. x Pal. Boxes x Pal. Bte / Pal. Krt. x Pal. Cajas x Pal. Кор. x Подд.	Mq. x Pal. Sqm x Pal. M ² / Pal. Qm x Pal. Mc. x Pal. Кв.М x Подд.	Peso x Pal. Weight x Pal. Poids / Pal. Gewicht x Pal. Peso x Pal. Вес x Подд. Kg
60x60 Naturale	9,5	2,78	3	1,080	22,92	40	43,20	917
30x60 Naturale - Dec. Rail	9,5	5,56	6	1,080	22,61	48	51,84	1085
15x60 Dec. Rail	9,5	11,11	12	1,080	25,00	50	54,00	1250
30x30 Mosaico 5X5	9,5	11,11	5	0,450	10,40	60	27,00	624
30x30 Mosaico Domino	9,5	11,11	5	0,450	12,50	60	27,00	750
28,5x29,3 Mosaico Arrows	9,5	11,98	5	0,417	12,50	60	25,02	750



Ivory Nat. Rett.
60x60 - 23^{5/8}x23^{5/8}"

Mosaico Arrows Ivory Nat.
28,5x29,3 - 11^{1/4}x 11^{9/16}"

APPLICAZIONI TECNICHE

Emilgroup mette a disposizione svariate tipologie di applicazioni tecniche per far sì che le eccellenti qualità estetiche e tecniche del gres porcellanato possano essere sfruttate e valorizzate nei contesti progettuali più ambiziosi e sfidanti. Sistemi ad alto coefficiente tecnologico, prestazionale e di innovazione, elaborati fin nei minimi dettagli, e personalizzati su misura, con l'intento di trovare sempre la risposta più adatta e congeniale alle complesse esigenze dell'architettura contemporanea.

TECHNICAL APPLICATIONS Emilgroup makes available a range of technical applications to ensure that porcelain stoneware's exquisite appearance and outstanding technical qualities can be exploited and appreciated to the full in the most ambitious, challenging projects. High-tech, high-performing, extremely innovative systems, specified down to the tiniest details and customised as required, aiming always to deliver the most suitable solution and the best fit for contemporary architecture's complex needs.

APPLICATIONS TECHNIQUES Emilgroup a mis au point plusieurs types d'applications techniques pour que les extraordinaires qualités esthétiques et techniques du grès cérame puissent être exploitées et mises en valeur dans les contextes conceptuels les plus variés et les plus complexes. Ces systèmes s'appuient sur une technologie de pointe, sur une performance de haut niveau et sur une forte innovation. Elaborés dans les moindres détails et personnalisés sur mesure, ils visent à fournir toujours la solution la plus adaptée et la plus juste pour remplir les critères sévères de l'architecture contemporaine.

TECHNISCHE ANWENDUNGSBEREICHE Emilgroup bietet Produkte für verschiedenste Anwendungsbereiche an, so dass die ausgezeichneten technischen und optischen Eigenschaften von Feinsteinzeug selbst in anspruchsvollsten Projekten optimal zur Geltung gebracht werden können. Die hochtechnologischen, leistungsfähigen und innovationsreichen Systeme, bei denen jedes Detail stimmt, warten mit maßgeschneiderten Lösungen auf, die den komplexen Gestaltungsanforderungen der modernen Architektur gerecht werden.

APLICACIONES TÉCNICAS Emilgroup pone a disposición varios tipos de aplicación técnica para conseguir que las excelentes cualidades estéticas y técnicas del gres porcelánico puedan aprovecharse y valorizarse en los contextos proyectivos más ambiciosos y osados. Sistemas de alto coeficiente tecnológico, de prestaciones y de innovación, elaborados hasta en el menor de los detalles, y personalizados a medida, con la intención de hallar siempre la respuesta más adecuada y en sintonía con las complejas exigencias de la arquitectura contemporánea.

ТЕХНИЧЕСКИЕ ПРИМЕНЕНИЯ Emilgroup предлагает продукцию для разнотипного технического применения, предназначенную для полноценного использования и valorизации великолепных эстетических и технических качеств керамогранита в самых амбициозных и смелых дизайнерских проектах. Это - системы с большим содержанием технологии, высокими характеристиками и инновациями, разработанные с учетом мельчайших деталей, индивидуализированные на заказ, для нахождения наиболее подходящего и лучшего ответа на сложные требования современной архитектуры.



Pave&Go

1

PAVE AND GO

Facciate ventilate

2



Pavimenti sopraelevati

3



PAVE AND GO

INNOVATIVO SISTEMA DI PAVIMENTAZIONE PER INTERNI

Un esclusivo e innovativo sistema ad aggancio per realizzare pavimentazioni interne con la massima facilità, velocità, versatilità e la garanzia di prestazioni tecniche di livello eccezionale. Con Pave and Go, le lastre in gres porcellanato Emilgroup a spessore 10 e 20 mm vengono integrate in un supporto poliuretano dotato di agganci perimetrali che permette un'installazione estremamente semplice, rapida e senza l'utilizzo di massetti in cemento o altri collanti.

INNOVATIVE INDOOR FLOORING SYSTEM An exclusive, innovative interlocking joint system for extremely easy, quick, versatile installation of indoor floorings with guaranteed outstanding technical performances. With Pave and Go, Emilgroup porcelain stoneware tiles 10 and 20 mm thick are integrated in a polyurethane backing with interlocking joints around the edge, allowing very fast, trouble-free installation without the use of cement screeds or other adhesives.

SYSTÈME RÉVOLUTIONNAIRE POUR LE CARRELAGE INTÉRIEUR Un système d'ancrage exclusif et innovant pour mettre en place un carrelage intérieur en toute simplicité, avec la plus grande rapidité et polyvalence, tout en assurant une performance technique exceptionnelle. Dans le système Pave and Go, les dalles en grès cérame Emilgroup, de 10 et 20 mm d'épaisseur, sont incorporées à un support polyuréthane entouré d'ancrages pour garantir une installation extrêmement simple et rapide, sans chapes en ciment ni colles.

INNOVATIVES SYSTEM FÜR BODENBELÄGE IM INNENBEREICH Exklusives und innovatives Klinkensystem für Bodenbeläge im Innenbereich: einfache und schnelle Verlegung, große Einsatzvielfalt und erstklassige Leistungsmerkmale. Die Bodenelemente von Pave and Go bestehen aus 10 bzw. 20 mm starken Feinsteinzeugplatten der Emilgroup, die mit einem Trägerelement aus Polyurethan verbunden werden, das umlaufend mit einem Nut-Feder-Verriegelungssystem gesichert ist. Dieses System ermöglicht eine schnelle und unkomplizierte Verlegung, ohne dass Zementestrich oder Kleber erforderlich sind.

INNOVADOR SISTEMA DE PAVIMENTACIÓN PARA INTERIORES Un exclusivo e innovador sistema de fijación para realizar pavimentaciones interiores con la máxima facilidad, velocidad y versatilidad y la garantía de unas prestaciones técnicas de nivel excepcional. Con Pave and Go, las placas de gres porcelánico de Emilgroup, de 10 y 20 mm de grosor, se integran en un soporte de poliuretano dotado de anclajes perimetrales que permite una instalación extremadamente sencilla, rápida y sin el uso de ninguna capa de relleno de cemento ni de otros adhesivos.

ИННОВАЦИОННАЯ СИСТЕМА НАСТИЛА ВНУТРЕННИХ ПОЛОВ Эксклюзивная и инновационная замковая система для чрезвычайно простого, быстрого и практичного настила внутренних полов, а также для обеспечения технических характеристик высочайшего уровня. При использовании Pave and Go керамогранитные плиты Emilgroup толщиной 10 и 20 мм устанавливаются на полиуретановую опору с периметральными креплениями, что позволяет выполнять чрезвычайно простую, быструю установку, без изготовления бетонных стяжек или же использования клеящих веществ.

Si consiglia di utilizzare Pave and Go Indoor 18 mm per interni residenziali e pubblici dove non transitano o stazionano carichi pesanti, mentre si consiglia di utilizzare Pave and Go Indoor 28 mm per pubblici e commerciali ad alto traffico perchè supporta un peso fino a 2000kg.

Pave and Go Indoor 18 mm is recommended for residential and public interiors without permanent or transient heavy loads, while Pave and Go Indoor 28 mm is recommended for intensively used public and commercial locations, since it withstands a weight up to 2000 kg.

Il est recommandé de poser Pave and Go Indoor 18 mm dans les intérieurs résidentiels et publics sans circulation ni présence de charges lourdes. Pave and Go Indoor 28 mm, par contre, peut être utilisé dans les lieux publics et commerciaux à passage intensif, en raison de sa résistance jusqu'à 2 000 kg.

Pave and Go Indoor 18 mm wird für private und öffentliche Innenbereiche empfohlen, in denen keine hohen Einzel- oder Verkehrslasten anfallen. Pave and Go Indoor 28 mm hingegen besitzt eine Tragfähigkeit bis zu 2.000 kg und ist daher für stark frequentierte öffentliche und gewerbliche Bereiche geeignet.

Se aconseja utilizar Pave and Go Indoor de 18 mm para revestir interiores residenciales y públicos por los que no vayan a transitar ni permanecer cargas pesadas. En cambio, se recomienda usar Pave and Go Indoor de 28 mm para cubrir superficies públicas y comerciales de tráfico intenso, pues esta versión soporta un peso de hasta 2000 kg.

Рекомендуется использовать Pave and Go Indoor 18 мм для отделки внутренних жилых и общественных площадей, на которые не оказываются высокие динамические и статические нагрузки, в то время как, Pave and Go Indoor 28 мм рекомендуется использовать в общественных и торговых объектах с высокой интенсивностью трафика, потому что этот материал выдерживает вес до 2000 кг.

SISTEMA AD INCASTRO MASCHIO-FEMMINA

Male-female interlocking joint system
Système à encastrement mâle-femelle
Nut-Feder-Verriegelungssystem
Sistema de encaje machihembrado
Система внутренних и наружных креплений

SUPPORTO IN POLIURETANO

Polyurethane backing
Support polyuréthane
Trägerplatte aus Polyurethan
Soporte de poliuretano
Полиуретановая основа

GRES PORCELLANATO 60x60 CM - 23^{5/8}"X 23^{5/8}" SPESSORE 10 E 20 MM

Porcelain Stoneware of 60x60 cm - 23^{5/8}" x 23^{5/8}" Thickness 10 and 20 mm
Grès cérame 60x60 cm - 23^{5/8}" x 23^{5/8}" Épaisseur 10 et 20 mm
Feinsteinzeug 60x60 cm - 23^{5/8}" x 23^{5/8}" Stärke 10 mm und 20 mm
Gres porcelánico de 60x60 cm - 23^{5/8}" x 23^{5/8}" de 10 y 20 mm de grosor
Керамогранит 60x60 см. 23^{5/8}" x 23^{5/8}" - толщина 10 и 20 мм

FUGA PERIMETRALE 2 MM (4 MM CON PIASTRELLE UNITE)

Perimeter joint of 2 mm (4 mm with tiles laid side by side)
Joint 2 mm (4 mm avec carreaux l'un à côté de l'autre)
Umlaufende Fuge 2 mm (4 mm zwischen den verriegelten Fliesen)
Junta perimetral de 2 mm (4 mm con azulejos yuxtapuestos)
Периметральный шов 2 мм (4 мм при соединенных плитках)

SPESSORE MODULO 18 MM E/O 28 MM

Module thickness 18 mm and/or 28 mm
Épaisseur Module 18 mm et/ou 28 mm
Modulstärke 18 mm und/oder 28 mm
Módulo de 18 mm y/o de 28 mm de grosor
Толщина модуля 18 мм или 28 мм

TEMPO DI POSA? 5 VOLTE INFERIORE RISPETTO AGLI ALTRI SISTEMI!

**INSTALLATION TIME?
5 TIMES LESS THAN WITH
OTHER SYSTEMS!** With the Pave
and Go one-click interlocking
joint installation system,
specifically developed for indoor
ceramic flooring, tiles can be
installed quickly and easily on
screeds or on top of existing
floorings. The tiles are just aligned
and clicked together to create a
paving ready for use at once.

**TEMPS DE POSE ?
5 FOIS PLUS RAPIDE QUE LES
AUTRES SYSTEMES!** Le système
Pave and Go à encastrement,
par simple clic, est fait tout
spécialement pour poser des
revêtements de sol en céramique
à l'intérieur. Il permet d'installer
les carreaux facilement et
rapidement sur des chapes ou
sur d'anciens revêtements de sol.
Il suffit de les aligner, puis de les
encastrer en un clic pour obtenir
un revêtement de sol utilisable
immédiatement.

**VERLEGEZEIT? EIN FÜNFTEL
DES ZEITAUFWANDS IM
VERGLEICH ZU ANDEREN
SYSTEMEN!** Das eigens für
keramische Bodenbeläge
im Innenbereich konzipierte
Klicksystem Pave and Go
ermöglicht die einfache und
zügige Verlegung von Fliesen
auf Estrich oder Altböden.
Der begehbare Bodenbelag
ist im Handumdrehen fertig;
die Fliesen brauchen lediglich
aneinandergelegt und
festgeklickt zu werden.

**¿TIEMPO DE COLOCACIÓN?
¡CINCO VECES INFERIOR
RESPECTO AL DE OTROS
SISTEMAS!** El sistema de
colocación mediante encaje con
clic Pave and Go, concebido ex
profeso para pavimentaciones de
cerámica para interiores, permite
colocar los azulejos de modo fácil
y rápido sobre capas de relleno o
sobre viejas pavimentaciones.
No hay más que alinearlas y
encajarlas con un simple clic para
contar con una pavimentación
que se puede pisar de inmediato.

**ВРЕМЯ УКЛАДКИ?
В 5 РАЗ МЕНЬШЕ, ЧЕМ
ПРИ УКЛАДКЕ ДРУГИХ
СИСТЕМ!**
Замковая система укладки
Pave and Go, специально
разработанная для настила
внутренних керамических
полов, позволяет легко и
быстро укладывать плиты
на стяжки или старые полы.
Необходимо лишь выровнять
их и состыковать замок, после
чего поверхность будет сразу
же пригодна для хождения.

Il sistema di posa a incastro con un clic Pave and Go, concepito appositamente per pavimentazioni in ceramica per interni, permette di posare le piastrelle facilmente e velocemente su massetti o su vecchie pavimentazioni. Occorre soltanto allinearle e incastrarle con un clic per ottenere una pavimentazione immediatamente calpestabile.



PULITO? NO COLLA! NO STUCCO! CALPESTABILE? SUBITO!

Per l'installazione del sistema Pave and Go bastano pochi attrezzi di uso comune e non occorrono malte, colle, massetti o altri prodotti chimici.

Grazie a ciò, non sono richiesti tempi di attesa, né particolari operazioni di pulizia, prima che i vostri clienti possano calpestare le superfici posate, ad esempio in un ufficio o ristorante o in un supermercato. L'installazione può avvenire anche contestualmente all'utilizzo del locale, pertanto non è necessario avere periodi di chiusure o fermi lavorativi. Pave and Go 28 mm è anche carrabile con una portata fino a 2000 kg.

CLEAN? NO GLUE! NO GROUT! READY FOR USE? AT ONCE! All it takes to install the Pave and Go system are a few standard tools, with no need for mortars, glues, screeds or other chemical products. This means there are no waiting times, or specific cleaning procedures, before your customers can start using the installed surfaces, in an office, restaurant or supermarket, for example. Installation can be carried out while the premises are in use, since no closures or stoppages for the works are required. Pave and Go 28 mm is also vehicle-resistant with load capacity up to 2000 kg.

PROPRE ? PAS DE COLLE ! PAS DE MORTIER ! UTILISABLE APRÈS COMBIEN DE TEMPS ? IMMÉDIATEMENT ! Quelques outils d'usage courant suffisent pour mettre en place le système Pave and Go, sans mortiers, colles, chapes ou autres produits chimiques. Autrement dit, pas de temps d'attente, pas d'interventions particulières de nettoyage avant que vos clients puissent marcher sur les surfaces posées, par exemple dans un bureau, un restaurant ou un supermarché. L'installation peut se faire pendant que le local est utilisé, autrement dit pas besoin de fermer ou d'interrompre l'activité professionnelle. Pave and Go 28 mm est aussi un sol carrossable, avec une résistance jusqu'à 2 000 kg.

SAUBER? KEIN KLEBER! KEINE FUGENMASSE! BEGEBBAR? SOFORT! Für die Verlegung des Systems Pave and Go reichen einige wenige branchenübliche Werkzeuge und sind keine Mörtel, Kleber, Estriche oder anderweitigen chemischen Erzeugnisse erforderlich. Folglich entfallen Wartezeiten und Reinigungsarbeiten, so dass die Belagflächen, etwa im Büro, im Restaurant oder im Supermarkt, sofort begehbar sind. Die Verlegung kann auch während des laufenden Betriebs vorgenommen werden, so dass keine Schließzeiten und Arbeitsausfälle entstehen. Pave and Go 28 mm ist auch mit Lasten bis zu 2.000 kg befahrbar.

¿LIMPIO? ¡SIN COLA! ¡SIN ESTUCOS! ¿TRANSITABLE? ¡ENSEGUIDA! Para la instalación del sistema Pave and Go son suficientes unas pocas herramientas de uso común y no se requieren morteros, colas, capas de relleno ni otros productos químicos. Por todo ello no van a ser necesarias operaciones de limpieza especiales ni ningún tiempo de espera antes de que tus clientes puedan transitar por las superficies colocadas, por una oficina, un restaurante o un supermercado, por ejemplo. La instalación se puede efectuar incluso simultáneamente al uso del local, por lo que no se requerirán periodos de cierre ni paradas para la ejecución de las obras. Por las superficies soladas con Pave and Go de 28 mm de grosor también pueden transitar vehículos de hasta 2000 kg de peso.

ЧИСТО? БЕЗ КЛЕЯ! БЕЗ ЗАТИРКИ! ВОЗМОЖНОСТЬ ХОЖДЕНИЯ? СРАЗУ! Для установки систем Pave and Go достаточно немного обычного инструмента и не требуется раствор, клей, стяжки или другие химические продукты. Благодаря этому не требуется время выдержки, а также выполнение особых операций чистки перед тем, как ваши клиенты начнут хождение по полу, например, в офисе, ресторане или супермаркете. Установку можно выполнять также и во время использования помещения, поэтому, самоустраниются периоды закрытия и прекращения работы. Благодаря выдерживаемой нагрузке в 2000 кг Pave and Go 28 мм допускает также движение транспортных средств.

AND IF I WANT TO CHANGE SOME ELEMENTS? VERY SIMPLE! Pave and Go elements are very easy to replace if necessary. Want to change the pattern? Broken or damaged element? You can remove single elements or whole groups - it's no problem with the removal tool. Replacement can be carried out while the premises are in use, since no closures or stoppages for the works are required.

ET POUR REMPLACER DES DALLES ? SUPER SIMPLE! Le cas échéant, les dalles Pave and Go peuvent être remplacées en toute simplicité. En cas de changement de design ? Une dalle s'est cassée ou abîmée ? Vous pouvez retirer une dalle seulement ou des groupes entiers. Avec l'outil de dépose, aucun problème. Le remplacement peut se faire pendant que le local est utilisé, autrement dit pas besoin de fermer ou d'interrompre l'activité professionnelle.

UND WENN DIE PLATTEN AUSGETAUSCHT WERDEN SOLLEN? EIN KINDERSPIEL! Die Module des Systems Pave and Go können bei Bedarf im Nu ausgetauscht werden. Neuer Look gefällig? Platte defekt? Die Platten können einzeln oder gruppenweise problemlos mit dem Hebewerkzeug entfernt werden. Der Austausch kann auch während des laufenden Betriebs vorgenommen werden, so dass keine Schließzeiten und Arbeitsausfälle entstehen.

¿Y SI QUIESERA CAMBIAR LAS PLACAS? ¡MUY FÁCIL! Las placas Pave and Go se pueden cambiar con extraordinaria facilidad, si es necesario. ¿Quieres cambiar el diseño? ¿Se ha roto o estropeado una placa? Con una ventosa u otra herramienta para la extracción, retirar una placa o quitar todo un conjunto de ellas no va a ser un problema. El cambio se puede llevar a cabo incluso simultáneamente al uso del local, por lo que no se requerirán períodos de cierre ni paradas para la ejecución de las obras.

ЗАМЕНА ПЛИТ? ПРОЩЕ НЕ БЫВАЕТ! В случае необходимости плиты Pave and Go можно очень легко заменить. Хотите изменить дизайн? Одна плитка разбилась или повредилась? Вы можете снять отдельные плиты или же целые группы. Благодаря съемному приспособлению это не является проблемой. Замену можно выполнять также и во время использования помещения, поэтому, самоустраиваются периоды закрытия и прекращения работы.



SOSTITUIRE LE LASTRE? SEMPLICISSIMO!

Le lastre Pave and Go possono essere sostituite con estrema facilità, se necessario. Volete cambiare il design? Una lastra si è rotta o rovinata? Potete togliere singole lastre o interi gruppi - con l'attrezzo di rimozione non è un problema. La sostituzione può avvenire anche contestualmente all'utilizzo del locale, pertanto non è necessario avere periodi di chiusure o fermi lavorativi.



È FACILE DA PULIRE? ASSOLUTAMENTE SÌ! FORMIDABILE!

I vostri clienti saranno soddisfatti del risultato: la pavimentazione, con le sue fughe integrate, sarà una superficie unica e continua. Le piastrelle in ceramica si contraddistinguono per le gradevoli tonalità di colore e la loro robustezza permette di mantenere nel tempo la bellezza delle strutture. Anche la manutenzione di una pavimentazione interna non è mai stata così facile! Le superfici sono resistenti alla sporcizia e possono essere pulite facilmente con comuni detersivi per piastrelle.



IS IT EASY TO CLEAN? ABSOLUTELY! INCREDIBLE! Your customers will be delighted with the result: the paving, with its integrated joints, will form a single, continuous surface. Thanks to the attractive colours and strength of the ceramic tiles, the structure will retain its beauty over time. Taking care of an indoor flooring has also never been so easy! The surfaces are resistant to dirt and can easily be cleaned with ordinary tile cleaners.

C'EST SIMPLE À NETTOYER ? ABSOLUMENT ! FORMIDABLE ! Vos clients adoreront le résultat : le revêtement de sol, avec ses joints intégrés, sera une surface unique et continue. Les carreaux en céramique se distinguent par leurs superbes nuances de couleur, et leur solidité assure la beauté des structures à très long terme. L'entretien d'un sol intérieur n'a jamais été aussi simple ! Les surfaces sont résistantes à la saleté. Elles peuvent être nettoyées avec des détergents ordinaires pour carrelage.

PFLEGELEICHT? SUPERPFLEGELEICHT! Ihre Kunden werden zufrieden sein: der Bodenbelag mit integrierten Fugen bildet eine nahtlose, einheitliche Fläche. Die Keramikfliesen zeichnen sich durch attraktive Farboptiken und eine hohe Langzeitqualität aus, was für einen dauerhaft schönen Bodenbelag bürgt. Die Pflege eines Indoor-Bodenbelags war noch nie so einfach! Die Oberflächen sind schmutzabweisend und können problemlos mit allen gängigen Fliesenreinigern gereinigt werden.

¿ES FÁCIL DE LIMPIAR? ¡SÍ, SIN DUDA! ¡FORMIDABLE! Tus clientes estarán satisfechos con el resultado: la pavimentación, con sus juntas integradas, configurará una superficie única y continua. Los azulejos de cerámica se distinguen por presentar unas agradables tonalidades cromáticas y su solidez permite mantener durante largo tiempo la belleza de las estructuras. ¡Además, el mantenimiento de un pavimento interior jamás ha sido tan fácil! Las superficies, resistentes a la suciedad, se pueden limpiar fácilmente con detergentes corrientes para azulejos.

ОНА ЛЕГКО ЧИСТИТСЯ? НЕСОМНЕННО! ПОРАЗИТЕЛЬНО! Ваши клиенты останутся довольны результатом: пол с интегрированными швами станет единой и сплошной поверхностью. Керамическая плитка отличается приятным цветом, а ее прочность позволяет сохранить во времени красоту конструкций. Даже уход за полом в помещении никогда не был столь простым! Поверхности устойчивы к загрязнению и могут легко очищаться обычными моющими средствами для плитки.



DESTINAZIONI D'USO

Pave and Go è la scelta ideale per tutti i contesti commerciali, pubblici e di lavoro nei quali è richiesto il perfetto bilanciamento tra estetica, praticità e prestazioni.

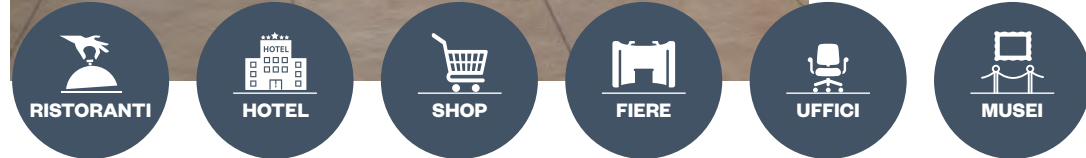
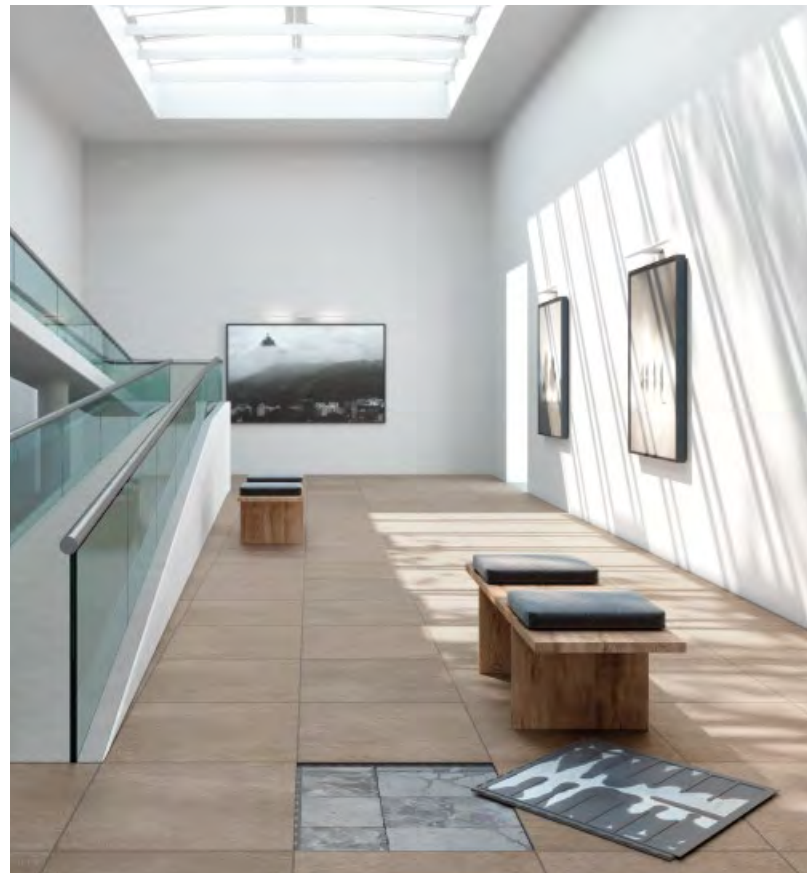

INTENDED USES Pave and Go is the ideal option for all commercial, public and working locations that demand the perfect combination of looks, convenience and performance.

DOMAINES D'APPLICATION Pave and Go est le choix idéal pour tous les projets commerciaux, publics et professionnels exigeant un parfait équilibre entre esthétique, fonctionnalité et performance.

ZWECKBESTIMMUNG Pave and Go ist ideal für alle gewerblichen, öffentlichen und Bürobereiche, in denen ein perfektes Zusammenspiel von Ästhetik, Zweckmäßigkeit und Leistungsmerkmalen erforderlich ist.

USOS PREVISTOS Pave and Go es la opción ideal para todos los contextos comerciales, públicos y laborales en los que se requiera un perfecto equilibrio entre estética, practicidad y prestaciones.

НАЗНАЧЕНИЕ Pave and Go - это наилучший выбор для любого применения: торговых площадей, общественных заведений и рабочих помещений, в которых требуется сбалансированность эстетики, практичности и высоких характеристик.

I NOSTRI DESIGN

Pave and Go Indoor offre una ricca scelta di proposte grafiche e stilistiche all'interno delle collezioni Emilgroup nel formato 60x60 cm a spessore 10 mm e 20 mm.

Pave and Go Indoor 28 mm è disponibile su richiesta per progetti superiori ai 2000 mq.

Pave and Go Indoor 28 mm is available on request for projects in excess of 2000 m².
 Pave and Go Indoor 28 mm est disponible sur demande pour les projets de plus de 2000 m².
 Pave and Go Indoor 28 mm ist auf Anfrage für Projekte über 2000 qm erhältlich.
 Pave and Go Indoor 28 mm se halla disponible bajo pedido para proyectos superiores a los 2000 m².
 Pave and Go Indoor 28 mm поставляются на заказ для проектов площадью от 2000 кв.м.



OUR DESIGNS Pave and Go Indoor offers a rich selection of patterns and styles from the Emilgroup collections in the 60x60 cm size with thickness of 10 and 20 mm.

LES DESIGNS Pave and Go Indoor multiplie les textures graphiques et les styles au sein des collections Emilgroup en format 60x60 cm, d'épaisseur 10 et 20 mm.

DESIGNVIELFALT Pave and Go Indoor bietet eine mannigfaltige Auswahl an Optiken und Stilen aus den Kollektionen der Emilgroup im 10 mm und 20 mm starken Format 60x60 cm.

LOS DISEÑOS Pave and Go Indoor ofrece una generosa selección de variantes gráficas y estilísticas dentro de las colecciones de Emilgroup en el formato de 60 x 60 cm, de 10 y de 20 mm de grosor.

НАШ ДИЗАЙН Pave and Go Indoor предлагает большой выбор графических и стилистических предложений в рамках коллекций Emilgroup в формате 60x60 см толщиной 10 и 20 мм.

INSTALLAZIONE

INSTALLATION
INSTALLATION
VERLEGUNG
INSTALACIÓN
УСТАНОВКА

1

Check that the installation screed or existing flooring is clean and flat.

Avant la pose, contrôler que la chape, ou l'ancien revêtement de sol, présente une surface propre et plate.

Kontrollieren, dass Estrich bzw. Altboden sauber und eben sind.

Comprobar que la capa de relleno o el pavimento viejo sobre el que va a ejecutarse el solado sea plano y esté limpio.

Убедитесь, что имеющаяся стяжка или пол, на который будет осуществляться укладка, является чистым и ровным.

2

Install the first element, placing it perpendicular with the adjacent walls.

Poser la première dalle de manière qu'elle soit parfaitement droite par rapport aux murs adjacents.

Die erste Platte rechtwinklig beginnend an der Wanddecke verlegen.

Colocar la primera placa en ángulo recto con respecto a las paredes adyacentes.

Уложите первую плитку перпендикулярно расположенным рядом стенам.

3-4

Continue installing, interlocking all elements on the right side, until the space is full.

Continuer la pose en encastrant les dalles toujours sur le côté droit jusqu'à remplir tout l'espace.

Die nächste Platte anlegen und festklicken. Bei der Verlegung von rechts nach links arbeiten, bis die Reihe vollständig ist.

Seguir con la colocación encajando las placas del lado derecho hasta llegar al final del espacio disponible.

Продолжите укладку, прикладывая и закрывая на замок плитки с правой стороны, до конца свободного места.

5

When the first row is complete, start again from the beginning, always ensuring that the elements are perpendicular.

Une fois terminée la première rangée, recommencer depuis le début en contrôlant toujours que les dalles sont parfaitement droites.

Nach Beendigung der ersten Reihe die zweite Reihe erneut von rechts beginnen und stets darauf achten, dass die Platten rechtwinklig verlegt sind.

Una vez colocada la primera fila seguir desde el principio asegurándose siempre de que las placas estén en ángulo recto.

Завершив первый ряд, начните укладку второго ряда от начала, всегда проверяя перпендикулярность сторон плит.

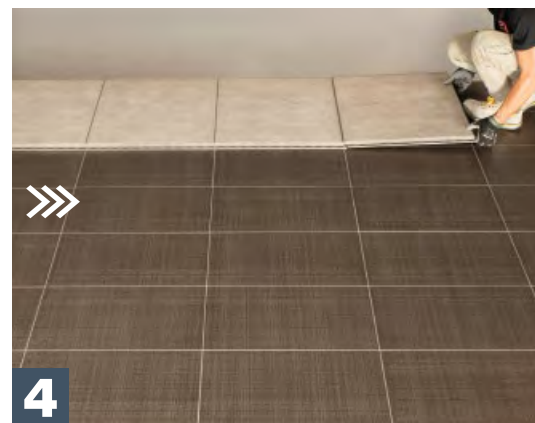
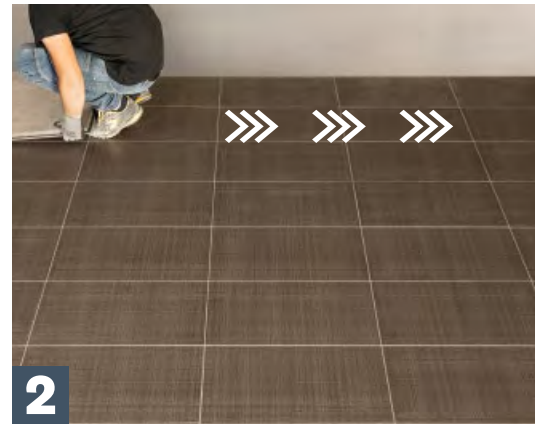
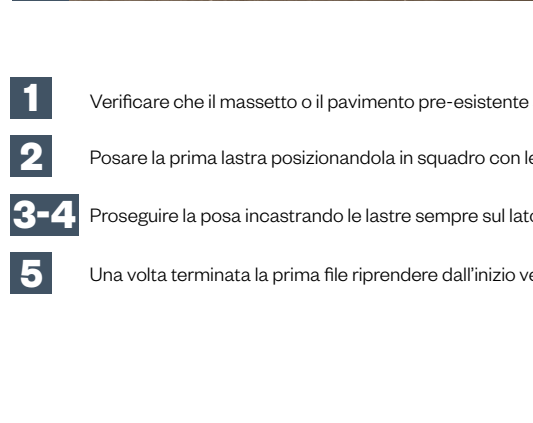
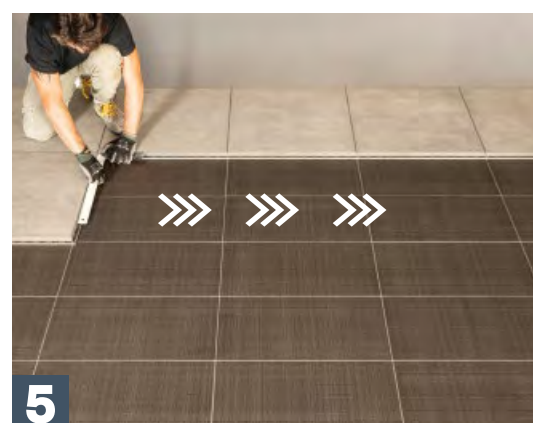
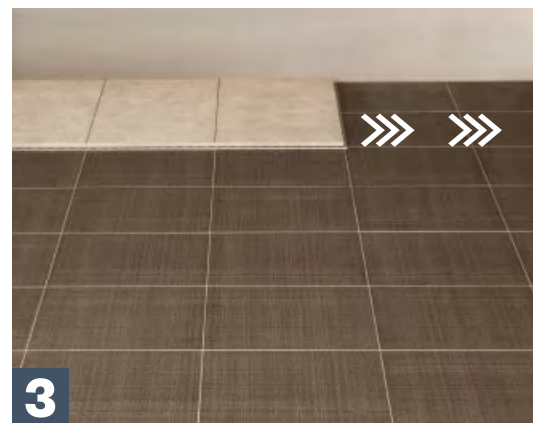
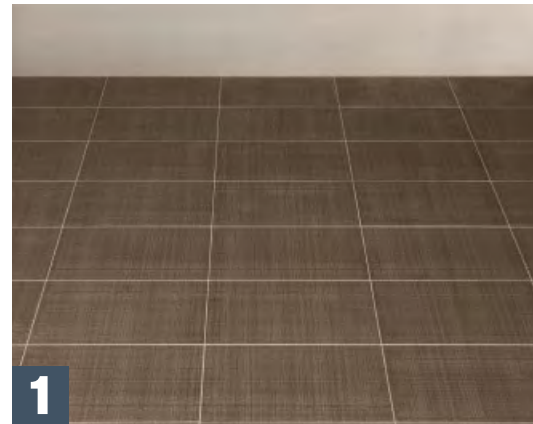

1 Verificare che il massetto o il pavimento pre-esistente su cui si eseguirà la posa sia pulito e planare.

2 Posare la prima lastra posizionandola in squadra con le pareti adiacenti.

3-4 Proseguire la posa incastrando le lastre sempre sul lato di destra fino alla fine dello spazio.

5 Una volta terminata la prima file riprendere dall'inizio verificando sempre lo squadra delle lastre.

7

When done, cut elements to size around the edges if necessary.

Le cas échéant, procéder à des découps périphériques.

Sofern erforderlich, nach Fertigstellung die Elemente für die Randbereiche schneiden.

Una vez terminado el trabajo efectuar los cortes perimetrales, si son necesarios.

После завершения работ выполните периметральную резку, если таковая необходима.

8

Elements can be cut with a tile cutter or angle-grinder.

Les dalles peuvent être découpées avec un coupe-carrelage ou une meuleuse d'angle.

Zum Schneiden der Platten eine Fliesenschneidmaschine oder einen Trennschneider verwenden.

Las placas se pueden cortar con un cortabalosas o una sierra circular de mano.

Плиты можно резать плиткорезом или же болгаркой.

9

Cutting of the PUR using a jigsaw with laminate blade.

Découper le matériel synthétique à base de polyuréthane avec une scie sauteuse munie d'une lame pour laminé et stratifié.

Schneiden des PUR-Kunststoffes mittels Stichsäge mit Laminat-Sägeblatt.

Cortar el material sintético a base de poliuretano con una sierra de calar con cuchilla para laminado.

Разрежьте синтетический материал на полиуретановой основе ножом.

10

Fill any gaps between the elements and the wall with silicone.

Au besoin, remplir de silicone l'espace entre les dalles et le mur.

Den Abstand zwischen Platte und Wand ggf. mit Silikon ausfüllen.

Si es necesario, rellenar con silicona el intersticio entre las placas y la pared.

В случае необходимости заполните силиконом шов между плитками и стеной.

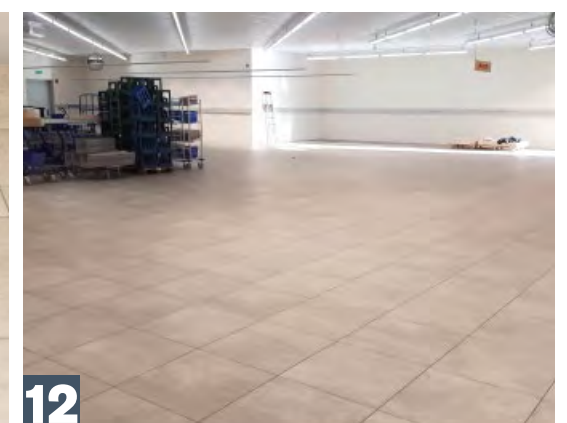
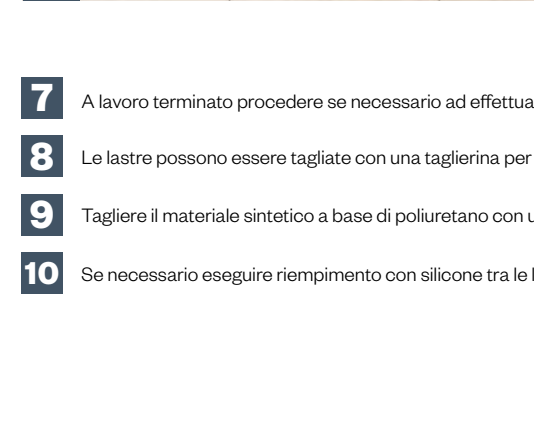
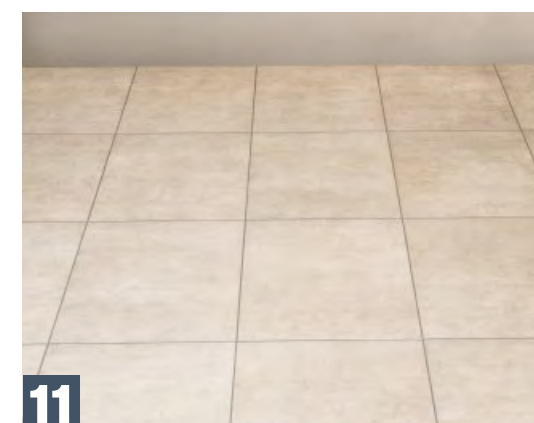

7 A lavoro terminato procedere se necessario ad effettuare i tagli perimetrali.

8 Le lastre possono essere tagliate con una taglierina per piastrelle o flessibile.

9 Tagliare il materiale sintetico a base di poliuretano con un cutter.

10 Se necessario eseguire riempimento con silicone tra le lastre ed il muro.

CARATTERISTICHE TECNICHE E GARANZIA



SISTEMA PAVE&GO 18MM

SIZE AND GENERAL INFORMATION	UNIT	SPECIFICATION
System size ¹	mm	600 x 600
Total System height ²	mm	18.0
Surface		ceramic tile
Tile size ³	mm	597 x 597 x 10.0
Backside of the flooring system		Polyurethane bars and locking system
Storage		Indoor storage is recommended
Laying temperature		-5 to + 35°C ⁴
UV resistance		Requirements fulfilled: no cracks, no blistering ⁵
Thermal Shock resistance According to EN 10545-9: 2000		PASS
INFORMATION FOR INSTALLATION		
Installation methods		cross-bond, half-offset or random structure
Possible staggered installation (multiples of)	mm	50
Usage		indoor areas
Floor heating		suitable ⁶
DATA FOR THE LAID ELEMENTS ⁷		
Weight approx.	kg / m ²	26
Average width of joint	mm	3
Fire behaviour according to DIN EN 13501(2010-01)		Bfl-s1
Resistance of the joints to liquids		Very good ⁸
Heat transfer resistance R	m ² K/W	0.124 ⁹
Anti-Slip-Class, abrasive-strength		According to the series - Technical Sheet
LOAD VALUES / TYPES OF USE ON A LEVELLED SURFACE		
Payload: Pallet truck with polyurethane or rubber wheels	kg	600
Point load at 2.5 x 2.5 cm	kg	275 ¹⁰
Possible applications: office space, shop-in-shop and pop-up systems, low loaded salesrooms.		
LOAD VALUES ON SUBFLOORS ¹¹		
Payload: Pallet truck with polyurethane or rubber wheels	kg	450
Point load at 2.5 x 2.5 cm	kg	200 ¹²
Possible applications: exhibition stands, private rooms, office space, low loaded salesrooms.		

¹ Tolerance element size: -0,0% / +0,07% of the nominal dimension.

² Thickness tolerance: ±5% of the nominal dimension.

³ See tile's tolerance from pag. 1, Ceramic Tile Technical Sheet.

⁴ For an easier installation, a previous storage of the elements in a closed room for 2 days is recommended; the more suitable room temperature for the storage must be kept above 15° C/59° F).

⁵ Color changes can still occur due to UV exposure or chemicals.

⁶ For floor heating, an object-related examination / calculation must be carried out by the specialist planner heating or heating engineer. Thermal resistance without heat transfer resistance R_{si}.

⁷ Observe the Information on laying floor system Pave & Go.

⁸ Polyurethane as material for the joints does not absorb any liquids. Stains can be removed. Organic liquids, especially solvents, can cause changes in colour when left too long on the joints.

Please refer to Pave & Go the cleaning instructions for flooring system.

⁹ For floor heating, an object-related examination / calculation must be carried out by the specialist planner heating or heating engineer. Thermal resistance without heat transfer resistance R_{si}.

¹⁰ Tested with tiles with a thickness of 10,0 mm and an average bending resistance of 50N/mm².

¹¹ In accordance with DIN 18202 increased requirements - Table 3 - line 4.

¹² Tested with tiles with a thickness of 10,0 mm and an average bending resistance of 50N/mm².

CARATTERISTICHE TECNICHE E GARANZIA



SISTEMA PAVE&GO 28MM

SIZE AND GENERAL INFORMATION	UNIT	SPECIFICATION
System size ¹	mm	599 x 599
Total System height ²	mm	28.0
Surface		ceramic tile
Tile size ³	mm	595 x 595 x 20.0
Backside of the flooring system		Polyurethane bars and locking system
Storage		Indoor storage is recommended
Laying temperature		-5 to + 35°C ⁴
Measurement of the walking noise in the test facility according to EN 16205		L _{n,walk,A} = 99 dB(A) - (98.7 dB(A) ± 0.2 dB(A).
Test of the improvement of impact sound insulation in the ceiling test facility According to EN ISO 10140		ΔL _w (C _i , Δ) = 15 (-10) dB
UV resistance		Requirements fulfilled: no cracks, no blistering ⁵
Thermal Shock resistance According to EN 10545-9: 2000		PASS
INFORMATION FOR INSTALLATION		
Installation methods		cross-bond, half-offset or random structure
Possible staggered installation (multiples of)	mm	50
Usage		indoor areas
Floor heating		suitable ⁶
DATA FOR THE LAID ELEMENTS ⁷		
Weight approx.	kg / m ²	46
Average width of joint	mm	4
Fire behaviour according to DIN EN 13501(2010-01)		Bfl-s1
Resistance of the joints to liquids		Very good ⁸
Heat transfer resistance R	m ² K/W	0.133 ⁹
Anti-Slip-Class, abrasive-strength		According to the series - Technical Sheet
LOAD VALUES ON SUBFLOORS ¹⁰		
Payload: Pallet truck with polyurethane or rubber wheels	kg	2000
Point load at 2.5 x 2.5 cm	kg	800 ¹¹
Possible applications: Showrooms commercial vehicles, retail space - shop fitting, public buildings. Forklift truck and electric lift truck up to max. 2800 kg. ³		

¹ Tolerance element size: -0,0% / +0,07% of the nominal dimension.

² Thickness tolerance: ±5% of the nominal dimension.

³ See tile's tolerance from pag. 1, Ceramic Tile Technical Sheet.

⁴ For an easier installation, a previous storage of the elements in a closed room for 2 days is recommended; the more suitable room temperature for the storage must be kept above 15° C/59° F).

⁵ Color changes can still occur due to UV exposure or chemicals.

⁶ For floor heating, an object-related examination / calculation must be carried out by the specialist planner heating or heating engineer. Thermal resistance without heat transfer resistance R_{si}.

⁷ Observe the Information on laying floor system Pave & Go.

⁸ Polyurethane as material for the joints does not absorb any liquids. Stains can be removed. Organic liquids, especially solvents, can cause changes in colour when left too long on the joints.

Please refer to Pave & Go the cleaning instructions for flooring system.

⁹ For floor heating, an object-related examination / calculation must be carried out by the specialist planner heating or heating engineer. Thermal resistance without heat transfer resistance R_{si}.

¹⁰ In accordance with DIN 18202 increased requirements - Table 3 - line 4.

¹¹ Ibidem.

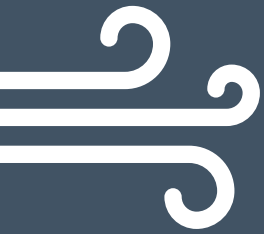

FACCIAE VENTILATE

La facciata ventilata (o parete ventilata) è un particolare tipo di rivestimento perimetrale delle pareti che prevede l'applicazione a secco, sulla superficie esterna dell'edificio, di pannelli di opportuno spessore, che non aderiscono alla parete di tamponamento ma ne risultano distanziati per formare un'intercapedine.

In questo modo, si ottiene la circolazione naturale dell'aria nello spazio dell'intercapedine, per effetto del moto convettivo prodotto dalla presenza di aperture disposte alla base e alla sommità della facciata. Tali facciate determinano il comfort (termo-acustico) degli ambienti interni e influenzano l'architettura del contesto esterno nel quale s'inseriscono.

Il team Engineering di Emilgroup è la struttura dedicata a supportare a 360° il cliente nella progettazione, installazione e certificazione dei sistemi di rivestimento superficiale per interni ed esterni.

Il team Engineering, con il suo approccio "taylor made" garantisce sicurezza e durabilità dell'intervento e assicura il massimo controllo dei fattori interni (disegno e morfologia dell'edificio) ed esterni (posizionamento dell'edificio rispetto ad aspetti di ventosità, sismicità, vicinanza al mare o altitudine particolare).

Emilgroup progetta e sviluppa i diversi sistemi di Parete Ventilata e Facciata Isolata Ventilata in grado di soddisfare le più svariate esigenze stilistiche e progettuali.



VENTILATED FAÇADE

A ventilated facade is a special type of surface for the outsides of walls in which panels of the appropriate thickness are dry-mounted on the building's outer surface in such a way that they do not adhere to the wall itself, meaning that a cavity is formed between the two layers. This allows air to circulate naturally through the cavity, due to the convection effect generated by openings at the top and bottom of the facade. Facades of this type increase the comfort level (temperature and noise) of the rooms inside the building and contribute to the architecture of their surrounding outdoor context.

The Emilgroup Engineering team has been specifically created to assist customers with all aspects of the design, installation and certification of indoor and outdoor surface covering systems. With its tailor-made approach, the Engineering team assures projects' safety and durability, as well as the maximum control of all factors, both internal (building design and layout) and external (positioning of the building in relation to wind direction, seismic risk, nearness to the sea or extreme altitudes).

Emilgroup designs and develops Ventilated Façade and Insulated Ventilated Façade systems capable of satisfying the most widely varying stylistic and architectural needs.

FAÇADE VENTILÉE

La façade ventilée (ou mur ventilé) est un revêtement particulier des murs par l'application à sec, sur la surface extérieure du bâtiment, de panneaux d'épaisseur adéquate qui, au lieu d'être posés directement sur le mur-écran, sont posés à une certaine distance pour former un vide technique. L'air peut ainsi circuler naturellement dans le vide technique par l'effet de convection généré par les ouvertures pratiquées à la base et au sommet de la façade. Ces façades assurent le confort (thermique et phonique) à l'intérieur et elles influencent l'architecture de l'environnement extérieur dans lequel elles s'inscrivent.

L'équipe Engineering d'Emilgroup assiste le client du début à la fin : étude de projet, installation et certification des systèmes de revêtement pour intérieur et extérieur. L'équipe Engineering adopte une approche « personnalisée » pour garantir la sécurité et la durabilité de l'intervention, ainsi que pour examiner et maîtriser les facteurs internes (géométrie et morphologie du bâtiment) et externes (exposition du bâtiment au vent, position dans une zone sismique, à proximité de la mer ou à une altitude particulière).

Emilgroup conçoit et réalise des systèmes de façade ventilée et de façade isolée ventilée qui répondent aux exigences stylistiques et conceptuelles les plus disparates.

VORGEHÄNGTE HINTERLÜFTETE FASSADE

Die vorgehängte hinterlüftete Fassade (VHF) ist eine Außenwandbekleidung im Trockenbausystem. Aufgrund der besonderen Konstruktionsweise werden die Fassadenplatten in geeigneter Stärke nicht direkt an der Gebäudewand angebracht, sondern es wird ein Zwischenraum belassen. In diesem Zwischenraum, auch Hinterlüftungsraum genannt, befindet sich ein natürlicher Luftstrom. Er wird hervorgerufen durch die thermische Konvektion, die aufgrund des Kamineffekts in der Fassade (oben und unten offene Ausführung) entsteht. Vorgehängte hinterlüftete Fassaden optimieren den Klima- und Geräuschkomfort in Innenräumen und werten das bauliche Umfeld auf.

Das Engineering-Team der Emilgroup unterstützt den Kunden rundum bei der Planung, Installation und Zertifizierung von Belagsystemen für Innen- und Außenbereiche. Das Engineering-Team bietet maßgeschneiderte Lösungen und bürgt so für ihre Sicherheit und Langzeitqualität. Gebäudeinterne (Gebäudeform und -aufbau) wie gebäudeexterne Einflussfaktoren (Gebäuelage in Bezug auf Windbelastung, Seismizität, Meeresnähe oder Höhenlage) werden genau unter die Lupe genommen.

Die Emilgroup plant und entwickelt vorgehängte hinterlüftete und gedämmte Fassadensysteme, die unterschiedlichsten Stil- und Projektanforderungen gerecht werden.

FACHADA VENTILADA

La fachada ventilada (o pared ventilada) es un tipo de revestimiento perimetrico especial de las paredes que prevé la aplicación en seco, sobre la superficie exterior del edificio, de paneles de un grosor adecuado que no están adheridos a la pared estructural del edificio sino que están ligeramente separados de la misma para formar una cámara aislante. De este modo se consigue que el aire circule de manera natural en el espacio de la cámara, por efecto del movimiento de convección generado por la presencia de aberturas dispuestas en la base y en la parte superior de la fachada. Estas fachadas determinan el confort (térmico y acústico) de los ámbitos interiores e influyen en la arquitectura del contexto exterior en el que se hallan.

El equipo de Ingeniería de Emilgroup es el departamento que le presta total apoyo y asesoramiento al cliente en la proyección, instalación y certificación de los sistemas de revestimiento superficial para interiores y exteriores. El equipo de Ingeniería, con su enfoque "a medida" garantiza la seguridad y la durabilidad de la intervención así como el máximo control de los factores interiores (dibujo y morfología del edificio) y exteriores (ubicación del edificio con respecto a aspectos como viento, sismos, cercanía al mar o altitud significativa).

Emilgroup diseña y desarrolla varios sistemas de Pared Ventilada y Fachada Aislada Ventilada capaces de satisfacer las más diversas exigencias estéticas y de proyecto.

ВЕНТИЛИРУЕМЫЙ ФАСАД

Вентилируемый фасад (или вентилируемая стена) - это особый тип наружной облицовки стен, предусматривающий сухую установку на наружные поверхности здания панелей необходимой толщины, которые не прилегают к стенам и отстоят от них на расстоянии, образуя тем самым воздушную камеру. Таким образом, под воздействием конвекции и при наличии проемов в нижней и в верхней части фасада обеспечивается естественная циркуляция воздуха в воздушной камере. Эти фасады создают термический и звуковой комфорт в помещениях и определяют архитектуру наружного окружения, в котором они находятся.

Инженерный отдел Emilgroup - это подразделение, обеспечивающее всеобъемлющую поддержку клиенту в проектировании, установке и сертификации систем облицовки внутренних и наружных поверхностей. Используя индивидуальный подход, инженерный отдел гарантирует безопасность и долговечность выполненных работ и наивысший контроль внутренних факторов (дизайн и морфология здания) и наружных (расположение здания по отношению к преобладающим ветрам, сейсмичность, близость к морю или большая высота над уровнем моря).

Emilgroup проектирует и разрабатывает различные системы вентилируемых фасадов и изолированных вентилируемых фасадов, которые способны удовлетворять самые разнообразные стилистические и проектные потребности.

PROGETTAZIONE E GESTIONE DEL CANTIERE

Tecnici qualificati e specializzati curano la progettazione esecutiva delle facciate, predisponendo:

- lay-out facciata
- sviluppo dei dettagli costruttivi (compresi raccordi angolo, serramenti, partenze e arrivi)
- redazione esecutivi di montaggio
- relazione di calcolo specifica per il cantiere in ottemperanza alle normative tecniche
- redazioni di as-built in corso d'opera per verifica corretto montaggio
- certificato di idoneità statica
- piano di manutenzione

Montatori qualificati e certificati realizzano la facciata garantendo qualità e durata.



A
Render
Rendu
Rendu
Rendering
Imagen digital
Рендер

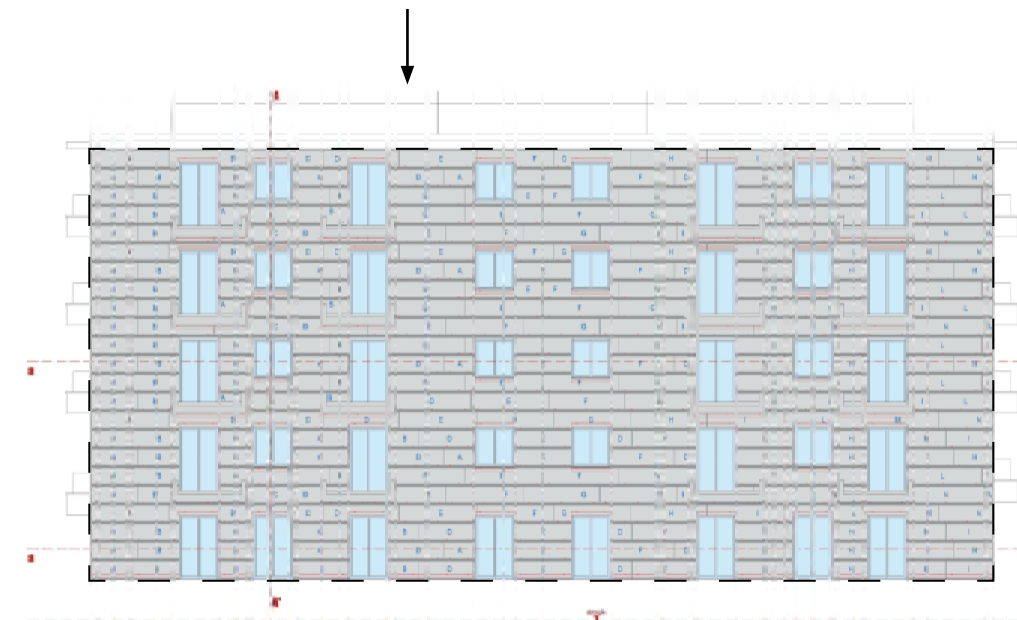

B
Progettazione strutturale
Structural design
Conception de la structure
Tragwerksplanung
Proyección estructural
Структурное проектирование



C
Progettazione architettonica
Architectural design
Projet architectural
Architekturplanung
Proyección arquitectónica
Архитектурное проектирование

DESIGN AND INSTALLATION MANAGEMENT

Skilled, specialised technical staff handle the executive design of facades, preparing:

- facade layout
- development of construction details (including corner connections, doors and windows and ends)
- working drawings for installation
- specific installation calculations to comply with technical regulations
- as-built reports while work is in progress to verify correct installation
- certificate of static suitability
- maintenance plan

Skilled, certified fitters construct the facade with quality and durability guaranteed.

ÉTUDE DE PROJET ET GESTION DU CHANTIER

Des techniciens qualifiés et spécialisés réalisent le projet d'exécution des façades:

- plan de la façade
- mise au point des détails de construction (y compris raccords d'angle, portes et fenêtres, départs et arrivées)
- rédaction des plans de montage
- note de calcul spécifique au chantier conformément aux réglementations techniques
- rédaction du plan de situation pendant le chantier pour contrôler le montage
- certificat de conformité de charge statique
- programme d'entretien

Des monteurs qualifiés et certifiés se chargent du montage de la façade pour garantir qualité et durabilité.

PLANUNG UND BAUSTELLENMANAGEMENT

Hochqualifizierte Spezialisten übernehmen die Ausführungsplanung der Fassaden, einschließlich:

- Fassadenlayout
- Bauteilkonstruktion (Eckverbindungen, Tür- und Fensteröffnungen, Fußpunkt und Dachrand)
- Montagepläne
- Berechnungsbericht für die Baustelle in Übereinstimmung mit den technischen Vorschriften
- As-Built-Dokumentation zur Prüfung der ordnungsgemäßen Montage
- Eignungsnachweis für statische Bauwerke
- Instandhaltungsplan

Die Installation der Fassade durch zertifizierte Fachmonteure gewährleistet hohe Qualität und eine lange Lebensdauer.

PROYECCIÓN Y GESTIÓN DE LAS OBRAS

Unos técnicos cualificados y especializados se encargan de la proyección ejecutiva de las fachadas, preparando:

- plano de la fachada
- desarrollo de los detalles constructivos (incluidos conductos angulares, cierres, puntos iniciales y terminales)
- redacción de detalles ejecutivos de montaje
- informe de cálculo específico para la obra en cumplimiento de las normas técnicas
- realización de planos de modificaciones constructivas durante la ejecución de la obra para el control de la correcta instalación
- certificado de idoneidad estática
- plan de mantenimiento

Montadores cualificados y dotados de certificación instalan la fachada garantizando calidad y durabilidad.

ПРОЕКТИРОВАНИЕ И УПРАВЛЕНИЕ СТРОИТЕЛЬСТВОМ

Квалифицированные и специализированные инженеры осуществляют исполнительное проектирование фасадов, готовя:

- планировку фасада
- разработку деталей конструкции (включая угловые соединения, дверные и оконные блоки, начало облицовки и ее завершение)
- составление исполнительных чертежей для монтажа
- специальные расчеты для строительства, выполняя требования технических норм
- составление отчета о ходе выполнения работ для проверки правильности монтажа
- сертификат статического соответствия
- план обслуживания

Квалифицированные и сертифицированные установщики изготавливают фасад, гарантируя качество и долговечность.

I SISTEMI: PARETE VENTILATA E FACCIATA ISOLATA VENTILATA

Emilgroup progetta e sviluppa i diversi sistemi in grado di soddisfare le più svariate esigenze stilistiche e progettuali:

- Parete ventilata
- Facciata isolata ventilata

Alla loro realizzazione collaborano aziende leader nei propri settori di riferimento fornendo un fondamentale contributo in termini di expertise e affidabilità. A seguito di accuratissime fasi di progettazione e test, le soluzioni si caratterizzano per una estrema semplicità di montaggio e si collocano al top della categoria dal punto di vista qualitativo e delle performance estetiche e funzionali.

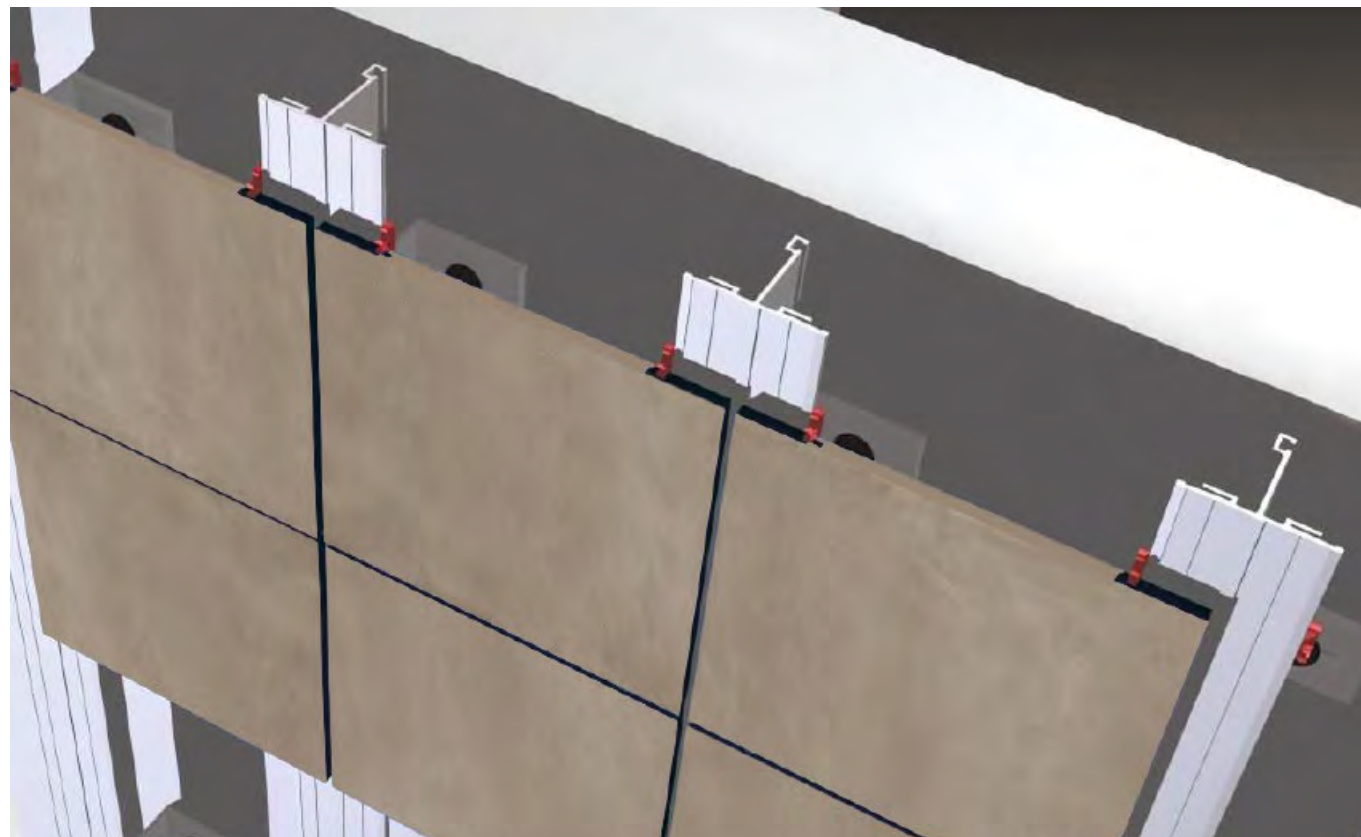

SYSTEMS: VENTILATED FAÇADE AND VENTILATED INSULATED FAÇADE

Emilgroup designs and develops various systems capable of satisfying the most widely varying stylistic and architectural needs: - Ventilated facade - Ventilated insulated facade These systems are constructed in association with companies which are leaders in their individual fields, with invaluable inputs in terms of expertise and reliability. Further to meticulous design and testing phases, solutions are extremely easy to install and are at the top of their class in terms of quality and aesthetic and functional performances.

LES SYSTÈMES : FAÇADE VENTILÉE ET FAÇADE ISOLÉE VENTILÉE

Emilgroup conçoit et réalise des systèmes qui répondent aux exigences stylistiques et conceptuelles les plus disparates : - Façade ventilée - Façade isolée ventilée Des entreprises leaders dans leur propre secteur de référence collaborent à leur réalisation, en apportant une assistance fondamentale en termes de compétence technique et de fiabilité. Après une étude de projet minutieuse et des essais approfondis, les solutions se distinguent par une extraordinaire simplicité de montage, et elles représentent ce qui se fait de mieux au niveau de la qualité, de l'esthétique et de la fonctionnalité.

SYSTEME: VORGEHÄNGTE HINTERLÜFTETE FASSADEN UND HINTERLÜFTETE GEDÄMMTE FASSADEN

Die Emilgroup plant und entwickelt Systeme, die verschiedensten Stil- und Projektanforderungen gerecht werden: - Vorgehängte hinterlüftete Fassaden (VHF) - Hinterlüftete gedämmte Fassaden An der Umsetzung sind marktführende Spezialisten der jeweiligen Branchen beteiligt, die einen grundlegenden Beitrag in puncto Knowhow und Qualität leisten. Alle Lösungen werden nach strengen Kriterien geplant und geprüft. Sie zeichnen sich durch eine einfache Installation aus und setzen in Hinsicht auf Qualität, Ästhetik und Funktionalität Spitzenstandards in ihrem Bereich.

SISTEMAS: FACHADA VENTILADA Y FACHADA AISLADA VENTILADA

Emilgroup proyecta y desarrolla varios sistemas capaces de satisfacer las más diversas exigencias estilísticas y proyectivas: - Fachada ventilada - Fachada aislada ventilada En su realización colaboran empresas punteras en sus sectores de referencia proporcionando una contribución fundamental en términos de pericia y fiabilidad. Fruto de una esmerada labor proyectiva avalada por rigurosas pruebas, las soluciones se caracterizan por una extraordinaria sencillez de montaje y se sitúan en lo más alto de la categoría desde el punto de vista cualitativo y de las prestaciones estéticas y funcionales.

СИСТЕМЫ: ВЕНТИЛИРУЕМЫЙ ФАСАД И ИЗОЛИРОВАННЫЙ ВЕНТИЛИРУЕМЫЙ ФАСАД

Emilgroup проектирует и разрабатывает различные системы, способные удовлетворять самые разнообразные стилистические и проектные потребности: - Вентилируемый фасад - Изолированный вентиляруемый фасад В их реализации сотрудничают компании-лидеры в своих отраслях, внося определяющий вклад в плане компетенции и надежности. После самых тщательных этапов проектирования и тестирования решения характеризуются чрезвычайной простотой монтажа и занимают топовые позиции в этой категории по качеству, эстетическим и функциональным характеристикам.

PARETE VENTILATA

Il sistema è costituito da profili in alluminio a T adeguatamente fissati alla parete esistente dell'edificio tramite staffe e tasselli. La tipologia e il dimensionamento dei profili può essere opportunamente personalizzato in base alle esigenze e alle caratteristiche dell'edificio da rivestire.

Un'ampia possibilità di regolazioni permette a questo sistema di adattarsi a qualsiasi conformazione di facciata, anche a quelle architettonicamente più complesse e di risolvere eventuali problematiche di fuori piombo della parete, anche su edifici molto alti.

Al fine di garantire l'isolamento termico si procede con la posa di materiali isolanti adeguati. Completano il sistema elementi di raccordo con serramenti e balconi. Il rivestimento costituito dalle lastre in gres Emilgroup viene successivamente ancorato ai profili tramite ganci in acciaio armonico studiati per permettere la massima garanzia di tenuta e al contempo la possibilità di resistere alle sollecitazioni quali carichi del vento e movimenti della struttura.

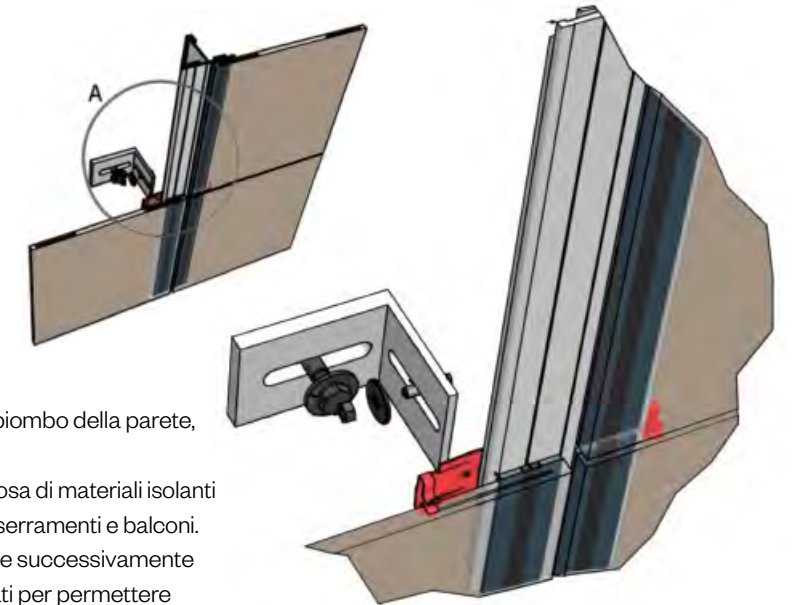

VENTILATED FAÇADE

The system consists of aluminium T-profiles, mounted on the building's existing wall using brackets and anchor bolts. The profile's type and size can be customised to requirements and the characteristics of the building for surface. A wide adjustment range enables this system to adapt to even the most architecturally complex facade and overcome any problems with non-perpendicular walls, even on very tall buildings. Thermal insulation is ensured by installing suitable insulation materials. The system is completed by elements which connect to doors, windows and balconies. The Emilgroup stoneware slab surface is then anchored to the profiles using harmonic steel hooks, developed to provide the firmest possible connection and also withstand stresses such as wind loads and structural shifting.

FAÇADE VENTILÉE

Le système se compose de profilés en T en aluminium solidarisés au gros-œuvre par des agrafes et par des chevilles. Le dimensionnement des profilés et leur nature peuvent être personnalisés selon les exigences et selon les caractéristiques du bâtiment. Très malléable, ce système s'adapte à n'importe quelle configuration de façade, y compris celles présentant une architecture plus complexe, et il permet de remédier aux éventuels écarts d'aplomb, y compris sur les bâtiments très hauts. Des matériaux isolants sont posés pour garantir le calorifugeage. Le système comprend aussi les éléments de raccord avec les portes, les fenêtres et les balcons. Les plaques en grès Emilgroup sont ensuite ancrées dans les profilés par des clips en acier à ressort, conçus non seulement pour sécuriser la fixation, mais aussi pour résister aux contraintes, comme la force du vent et les mouvements de la structure.

VORGEHÄNGTE HINTERLÜFTETE FASSADE

Das System besteht aus T-förmigen Aluminiumprofilen, die an der Außenwand des Gebäudes mit Konsolen und Dübeln befestigt werden. Form und Dimensionierung der Profile sind spezifisch auf die Anforderungen und Gegebenheiten des zu verkleidenden Gebäudes auslegbar. Aufgrund der zahlreichen Justiermöglichkeiten kann das System auf alle, auch komplexe Fassadenformen abgestimmt werden und etwaige Lotabweichungen der Wand, selbst bei hohen Gebäuden, ausgleichen. Geeignete Dämmstoffe gewährleisten die Wärmedämmung. Abgerundet wird das System durch Ergänzungsstücke für Türen, Fenster und Balkons. Die Fassadenbekleidung aus Feinsteinzeugplatten der Emilgroup wird an den Profilen der Unterkonstruktion mit Hilfe von Ankern aus Federstahl befestigt, die höchste Dichtigkeit und zugleich Widerstandsfähigkeit gegenüber Windlasten und Bewegungen der Unterkonstruktion gewährleisten.

FACHADA VENTILADA

El sistema está constituido por perfiles de aluminio en forma de T oportunamente anclados a la pared existente del edificio por medio de elementos de fijación y tacos. El tipo y el tamaño de los perfiles se puede personalizar oportunamente en función de las necesidades y características del edificio que se vaya a revestir. La posibilidad de aplicar un amplio abanico de regulaciones hace que este sistema se pueda adaptar a fachadas con conformaciones de lo más diversas, incluidas las arquitectónicamente más complejas, y resolver eventuales dificultades ante paredes fuera de plomo, aun en edificios muy altos. Con el fin de garantizar el aislamiento térmico se colocan materiales aislantes adecuados. Completan el sistema elementos de conexión con puertas, ventanas y balcones. A continuación el revestimiento constituido por las placas de gres de Emilgroup se ancla a los perfiles por medio de ganchos de acero armónico estudiados para asegurar la máxima sujeción y al mismo tiempo la máxima resistencia frente a cargas de viento y movimientos de la estructura.

ВЕНТИЛИРУЕМЫЙ ФАСАД

Система состоит из T-образных алюминиевых профилей, закрепленных на существующей стене здания при помощи кронштейнов и дюбелей. Тип и размеры профилей могут соответствовать индивидуальным требованиям, зависящим от потребностей и от характеристик облицовываемого здания. Широкие возможности регулировки позволяют этой системе адаптироваться к любой форме фасада, даже к самой сложной с архитектурной точки зрения, и решать проблемы неперпендикулярности стен, даже у очень высоких зданий. Для обеспечения теплоизоляции осуществляется укладка соответствующих изолирующих материалов. Дополняют систему элементы соединения с дверными и оконными блоками, а также с балконами. Облицовка, состоящая из керамогранитных плит Emilgroup, фиксируется на профилях креплениями из пружинной стали, разработанными таким образом, чтобы обеспечивать наивысшую надежность и вместе с тем возможность выдерживать такие нагрузки, как ветровые и подвижки всей конструкции.

FACCIATA ISOLATA VENTILATA

Isotec Parete® è un sistema termoisolante che consente di comporre a secco un cappotto isolante e strutturale, per la realizzazione di facciate ventilate. Tale pannello, in un'unica soluzione tecnica, crea un cappotto esterno termoisolante continuo e omogeneo e una struttura di supporto per la finitura esterna di rivestimento.

Il correntino portante, integrato al pannello, forma una camera d'aria ventilata tra pannello isolante e finitura di facciata, in grado di rimuovere l'umidità dall'intercapedine ed asportare il calore in eccesso. Il pannello ha un'anima in poliuretano, dall'altissima prestazione isolante (conduttività termica dichiarata λ_D 0,022 W/mK), è estremamente semplice e veloce da posare. Il pannello può essere fissato sia in orizzontale che in verticale, a seconda del formato della lastra gres Emilgroup, che verrà successivamente fissata al correntino mediante appositi morsetti in acciaio armonico. Il pannello è disponibile in diversi spessori, da 60 a 160 mm, per rispondere alle diverse esigenze termiche dell'edificio, in ottemperanza alle norme energetiche vigenti.



ISOTEC
PARETE



VENTILATED INSULATED FAÇADE

Isotec Parete® is a thermal insulation system allowing the dry construction of a structural insulating jacket for the creation of ventilated facades. The panel creates a continuous, uniform external thermal insulation jacket and simultaneously a supporting structure for the outer finishing cladding. The supporting rail integral with the panel creates a ventilated air gap between the insulating panel and the outer finishing cladding, to remove moisture from the cavity and disperse surplus heat. The panel has a polyurethane core with extremely high insulating performance (rated thermal conductivity λ_D 0,022 W/mK), and is extremely quick and easy to install. The panel can be mounted either horizontal or vertical, depending on the size of the Emilgroup stoneware slab, which will then be anchored to the rail with special harmonic steel clamps. The panel is available in various thicknesses, from 60 to 160 mm, to meet the building's different thermal requirements, in compliance with the relevant energy regulations.

FAÇADE ISOLÉE VENTILÉE

Isotec Parete® est un système d'isolation thermique qui permet de composer, à sec, un mur manteau isolant et structurel pour la réalisation des façades ventilées. En une seule solution technique, ce panneau forme à la fois une enveloppe extérieure thermo-isolante continue et uniforme, et une structure de support pour la finition extérieure du revêtement. Le liteau intégré au panneau forme une lame d'air ventilée entre le panneau isolant et la finition, en mesure de supprimer l'humidité dans le vide technique et d'évacuer l'excès de chaleur. Le panneau a une âme en polyuréthane à haute performance thermique (conductivité thermique déclarée λ_D 0,022 W/mK). Sa pose est extrêmement simple et rapide. Le panneau peut être fixé à l'horizontale ou à la verticale, selon le format de la plaque en grès Emilgroup qui sera ensuite attachée au linteau par des clips spéciaux en acier à ressort. Le panneau est disponible en plusieurs épaisseurs, de 60 à 160 mm, pour répondre aux différentes exigences thermiques du bâtiment, conformément aux normes en vigueur en matière d'efficacité énergétique.

HINTERLÜFTETE, GEDÄMMTE FASSADEN

Isotec Parete® ist ein Dämmsystem, das im Trockenbau als Wärmedämm- und Tragverbundsystem für hinterlüftete Fassaden ausgeführt wird. Die Dämmplatte bildet als einschalige Lösung ein durchgängiges und homogenes Wärmedämmverbundsystem an der Außenwand und eine Tragkonstruktion für die Fassadenbekleidung. Das in die Dämmplatte integrierte Tragprofil sorgt für einen Hinterlüftungsspalt zwischen Dämmplatte und Fassadenbekleidung, aus dem Feuchtigkeit und Wärme abgeführt werden. Die Dämmplatte mit einem Dämmkern aus PU-Schaum (Wärmeleitfähigkeit λ_D 0,022 W/mK) kann einfach und zügig installiert werden. Die Dämmplatte ist sowohl hochkant als auch quer montierbar, entsprechend dem Format der Emilgroup-Feinsteinzeugplatte. Zum Schluss wird die Feinsteinzeugplatte mit Hilfe von Ankern aus Federstahl am Tragprofil befestigt. Die Dämmplatte ist in unterschiedlichen Dicken von 60 bis 160 mm je nach Dämmungsbedarf des Gebäudes und gemäß den geltenden Vorschriften zur Energieeinsparung erhältlich.

FACHADA AISLADA VENTILADA

Isotec Parete® es un sistema termoaislante que permite instalar en seco capas aislantes y estructurales para la realización de fachadas ventiladas. Este panel, en una única solución técnica, crea una capa exterior termoaislante continua y homogénea y una estructura de sostén para el acabado exterior de revestimiento. La vigueta de sostén, integrada en el panel, forma una cámara ventilada entre el panel aislante y el acabado de la fachada, capaz de eliminar el calor excesivo y la humedad del intersticio. El panel, que tiene una ánima de poliuretano de muy elevado poder aislante (conductividad térmica declarada λ_D 0,022 W/mK), se coloca de manera muy sencilla y rápida. El panel se puede fijar tanto en horizontal como en vertical, según el formato de la placa de gres de Emilgroup, que a continuación se sujetará a la vigueta mediante mordazas de acero armónico. El panel se halla disponible en varios grosores, de 60 a 160 mm, para responder a las diversas exigencias térmicas de los edificios, en cumplimiento de las normas energéticas vigentes.

ИЗОЛИРОВАННЫЙ ВЕНТИЛИРУЕМЫЙ ФАСАД

Isotec Parete® - это теплоизолирующая система, позволяющая изготовлять сухим способом изолирующую и несущую облицовку для установки вентилируемого фасада. Эта панель единым техническим решением создает сплошную и однородную теплоизолирующую наружную облицовку и несущую конструкцию для наружной отделки. Встроенный в панель несущий профиль образует вентилируемую воздушную камеру между изолирующей панелью и отделкой фасада, способную отводить влагу из воздушной камеры и избыточное тепло. Панель имеет полиуретановую сердцевину с очень высокой изолирующей способностью (заявленная теплопроводность - λ_D 0,022 W/mK) и очень просто и быстро устанавливается. Панель можно крепить как горизонтально, так и вертикально, в зависимости от формата керамогранитной плиты Emilgroup, которая затем будет зафиксирована на профиле специальными креплениями из пружинящей стали. Панель может иметь разную толщину, от 60 до 160 мм, чтобы отвечать на различные теплоизоляционные потребности здания, выполняя действующие энергетические стандарты.

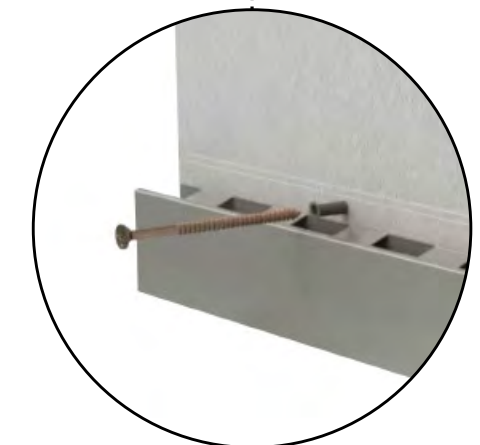
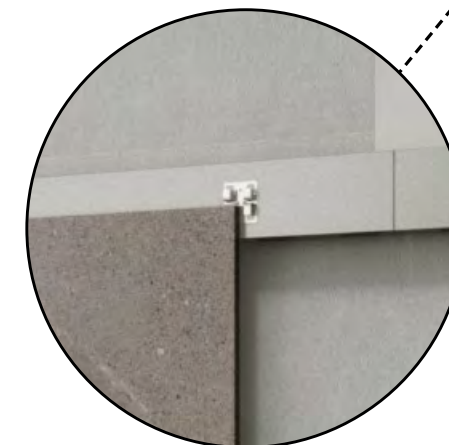
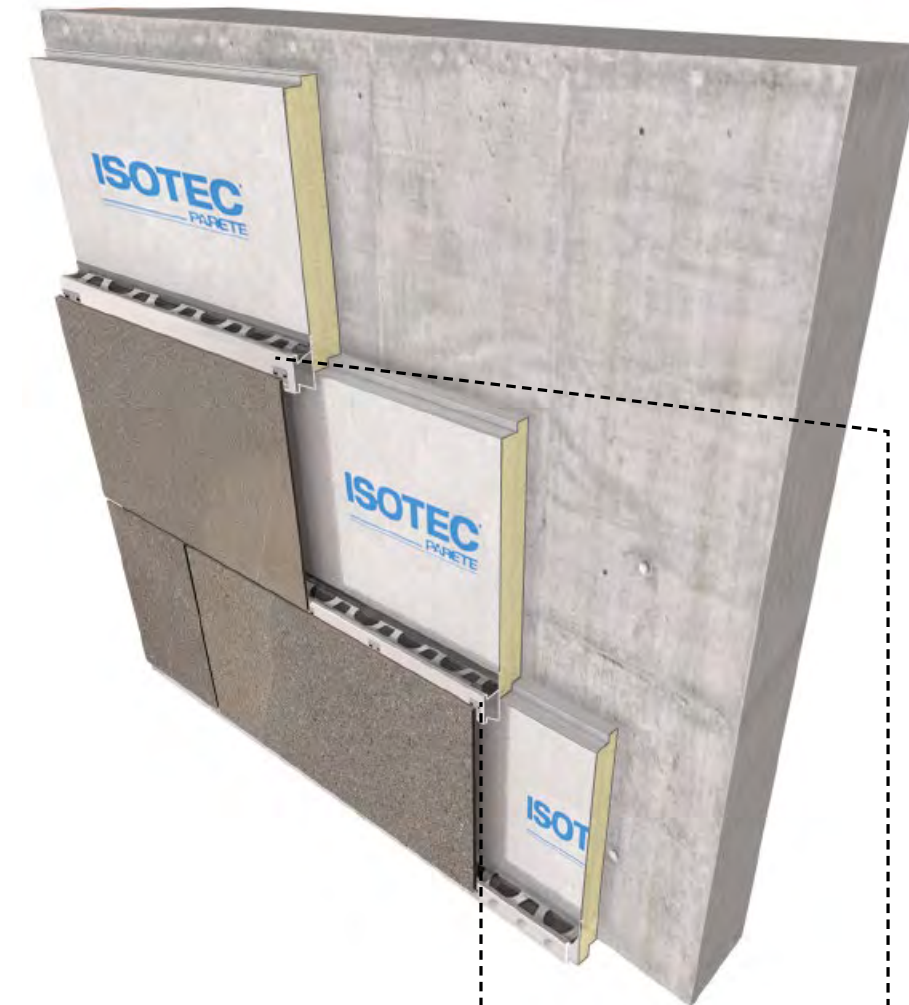

GLI AGGANCI

La facciate ventilate proposte da Emilgroup sono pensate per soddisfare le più svariate esigenze stilistiche, funzionali e strutturali espresse da progettisti, architetti e designer. Per riuscire in questo scopo, sono stati concepiti tre specifici sistemi di aggancio, adatti alla realizzazione di diversi tipi di soluzioni.

- SISTEMA A VISTA
- SISTEMA A SCOMPARSA
- SISTEMA INCOLLATO

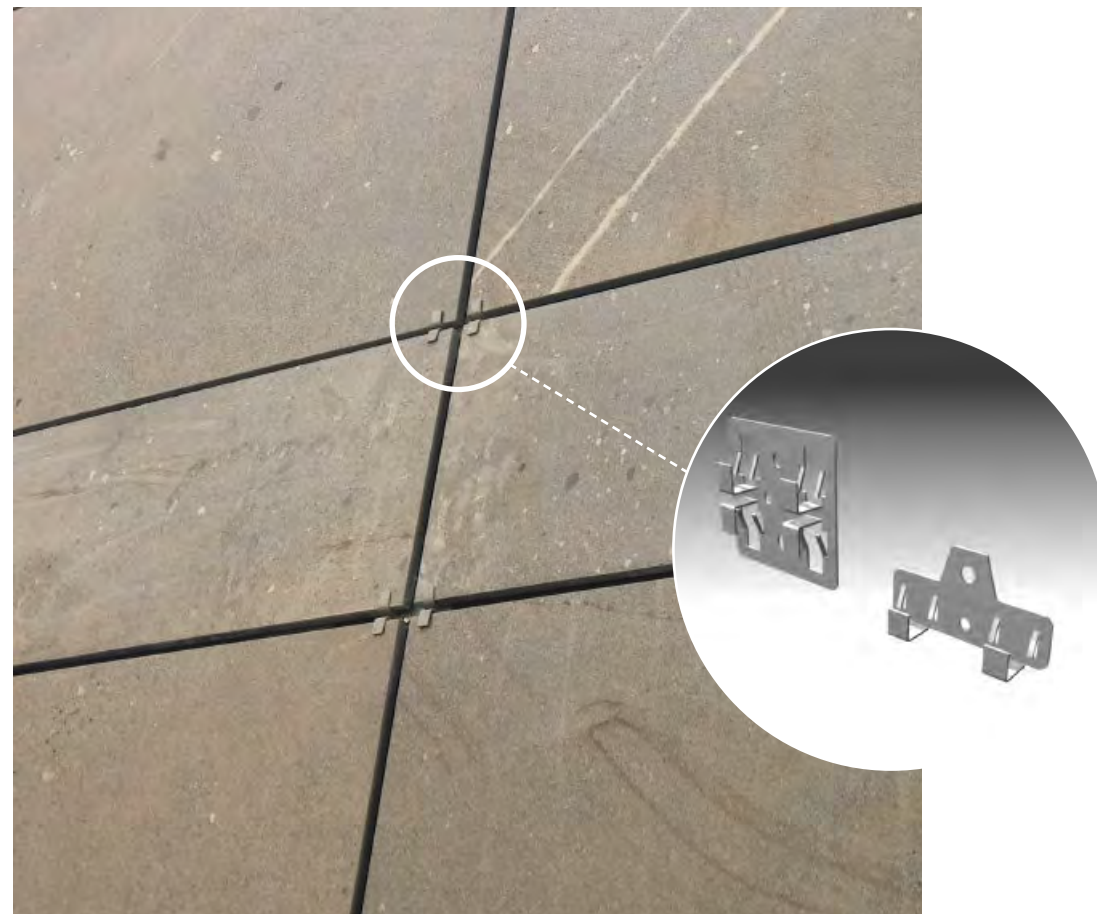

SISTEMA A VISTA
Visible anchor system
Système apparent
Sichtbare Befestigung
Sistema a la vista
Наружная система



SISTEMA A SCOMPARSA
Hidden anchor system
Système non apparent
Unsichtbare Befestigung
Sistema oculto
Скрытая система

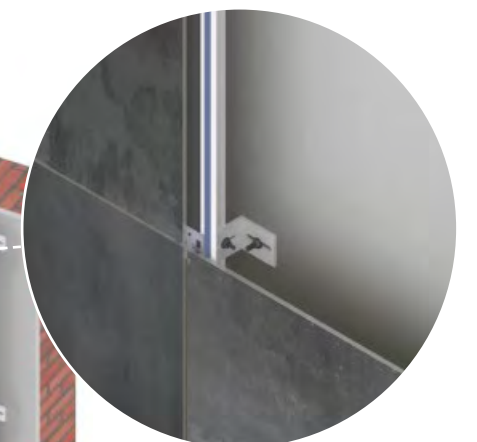
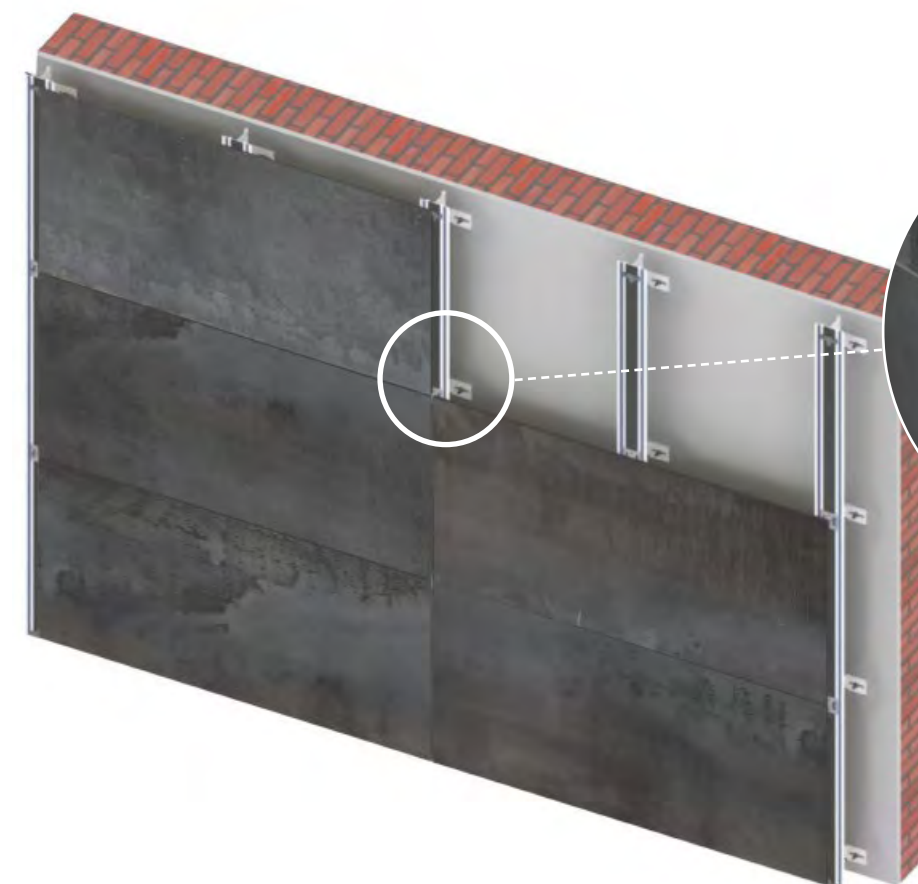
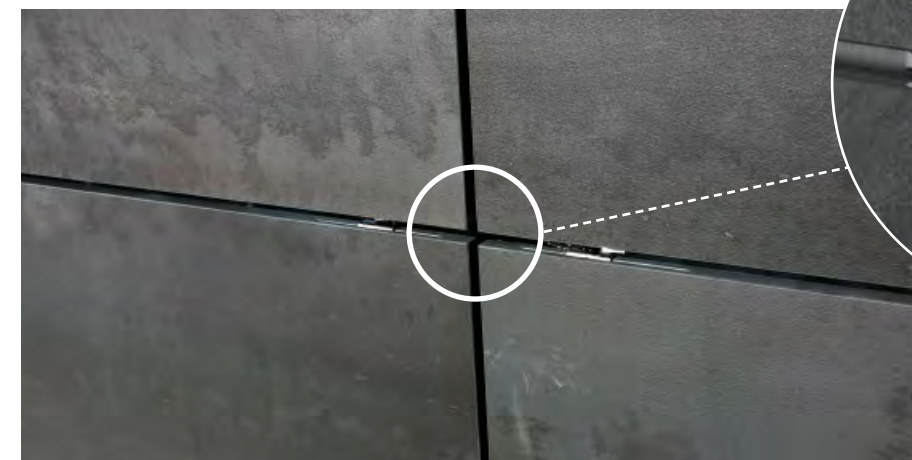

SISTEMA INCOLLATO
Glued anchor system
Système collé
Befestigung durch Klebung
Sistema encolado
Наклеиваемая система

MOUNTING FIXTURES

Emilgroup ventilated facades are designed to cover all the various demands of engineers, architects and designers in terms of appearance, function and structure. This is achieved with aid of three specific anchor systems, allowing the realisation of different types of solutions.

- Visible anchor system
- Hidden anchor system
- Glued anchor system

LES ANCRAGES

Les façades ventilées Emilgroup sont conçues pour répondre aux exigences les plus disparates des concepteurs, architectes et designers en matière d'esthétique, de fonctionnalité et de structure. Trois systèmes d'ancrage ont été mis au point pour pouvoir se plier à tous les critères du projet.

- Système apparent
- Système non apparent
- Système collé

BEFESTIGUNGEN

Die vorgehängten hinterlüfteten Fassaden der Emilgroup sind für die verschiedensten Stil-, Funktions- und Tragwerkanforderungen von Planern, Architekten und Designern konzipiert. Hierzu wurden drei Befestigungssysteme für unterschiedliche Lösungen entwickelt.

- Sichtbare Befestigung
- Unsichtbare Befestigung
- Befestigung durch Klebung

ANCLAJES

Las fachadas ventiladas propuestas por Emilgroup están pensadas para satisfacer las más diversas exigencias estilísticas, funcionales y estructurales expresadas por proyectistas, arquitectos y diseñadores. Para alcanzar este objetivo se han concebido tres sistemas de anclaje, adecuados para la realización de varios tipos de soluciones.

- Sistema a la vista
- Sistema oculto
- Sistema encolado

КРЕПЛЕНИЯ

Предлагаемые Emilgroup вентилируемые фасады разработаны для удовлетворения самых разнообразных стилистических, функциональных и структурных потребностей, выдвигаемых проектировщиками, архитекторами и дизайнерами. Для этого были разработаны три специальные системы крепления, пригодные для реализации решений разного типа.

- Наружная система
- Скрытая система
- Наклеиваемая система



PAVIMENTI SOPRAELEVATI



PAVIMENTI SOPRAELEVATI INTERNI

Il pavimento sopraelevato è nato per conciliare due caratteristiche degli edifici che, con le soluzioni fin qui utilizzate, sono in contraddizione fra di loro: quella dell'immutabilità delle strutture murarie e, di contro, la flessibilità ed intercambiabilità che dovrebbero avere i vari impianti, problema molto sentito soprattutto in uffici, banche, centri di calcolo etc. L'aggiunta imprevista o lo spostamento di un posto di lavoro, lo spostamento di un punto luce o di un telefono creava una serie di problemi che si risolvevano con una serie di disagi e costi abbastanza elevati. Il pavimento sopraelevato risolve definitivamente qualsiasi problema di spostamenti, manutenzioni e aggiunte senza creare problemi, riducendo drasticamente i tempi di intervento, diventando così in breve tempo più economico rispetto ad un pavimento tradizionale.

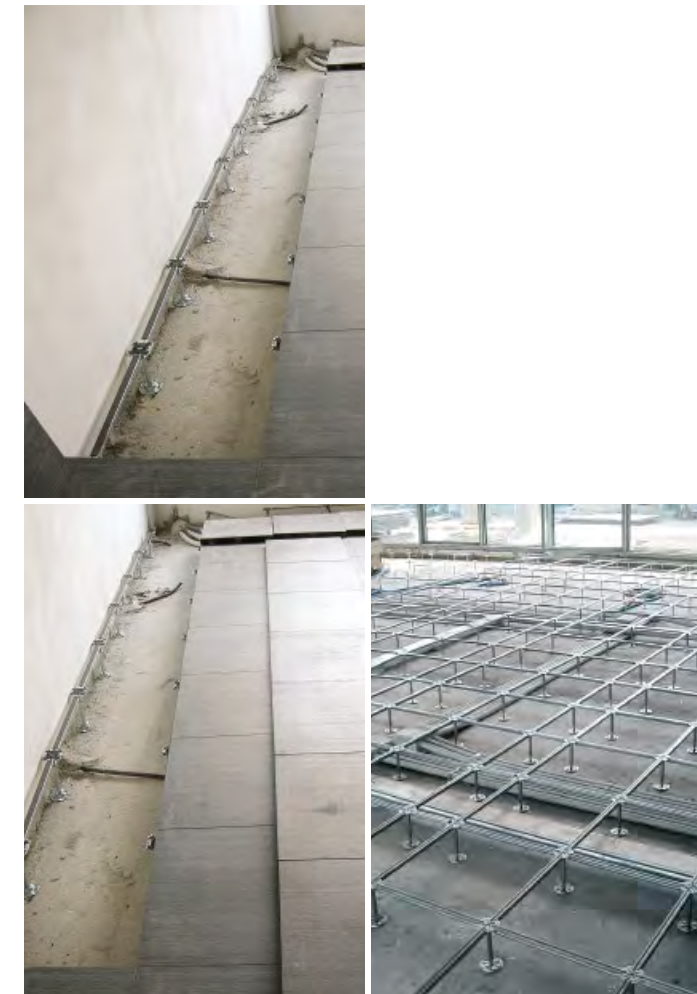

INDOOR CAVITY FLOORS

Cavity floors resolve two requirements of buildings which are otherwise mutually exclusive: unchangeable building structures and, on the other hand, flexibility and interchangeability of plant - an essential requirement particularly in offices, banks, data centres, etc. Unexpectedly adding or removing a work station, moving a power socket or phone connection can create problems which are troublesome and costly to solve. Cavity floors solve problems of maintenance, movement and adding/removing infrastructure once and for all, and are thus soon more cost effective than conventional flooring solutions.

PLANCHERS SURÉLEVÉS INTÉRIEURS

Le plancher surélevé sert à concilier deux caractéristiques du bâtiment que les solutions actuelles continuent à placer en antagonisme : d'une part l'immuabilité de la grosse maçonnerie, de l'autre la flexibilité et l'interchangeabilité que devraient avoir les différents équipements. Il s'agit là d'un problème très fréquent, notamment dans les bureaux, les banques, les centres de traitement de données etc. L'ajout soudain ou le déplacement d'un poste de travail, le déplacement d'un luminaire ou d'un téléphone posaient toute une série de problèmes qui entraînaient beaucoup d'inconvénients et des frais significatifs. Le plancher surélevé apporte une solution définitive à tous les problèmes de déplacement, de maintenance et d'ajout en abrégant énormément les délais d'intervention et en devenant ainsi, en peu de temps, plus économique qu'un plancher traditionnel.

DOPPELBÖDEN FÜR INNENRÄUME

Mit Doppelböden gelingt es, bestimmte Eigenschaften zu vereinen, die in technischer Hinsicht bisher gegensätzlich waren: einerseits die Unveränderlichkeit von Mauerwerk und andererseits die bei den verschiedenen technischen Anlagen erforderliche Flexibilität und Austauschbarkeit. Dieses Problem stellte sich vor allem in Büros, Banken, Rechenzentren usw., wo das Hinzufügen oder Verlegen eines Arbeitsplatzes, das Versetzen einer Lampe oder eines Telefons häufig mit großem Aufwand und relativ hohen Kosten verbunden war. Ein Doppelboden erlaubt problemloses Versetzen, Hinzufügen und Instandhalten und reduziert erheblich den dafür erforderlichen zeitlichen Aufwand. Deshalb erweist sich ein solches System im Vergleich zu einem herkömmlichen Bodenbelag innerhalb kurzer Zeit als wesentlich wirtschaftlicher.

PAVIMENTOS SOBREELEVADOS INTERIORES

El pavimento sobreelevado nació para compatibilizar dos características de los edificios que, con las soluciones aplicadas hasta ahora, estaban en contradicción: por una parte la inmutabilidad de las estructuras de las paredes y por la otra la flexibilidad y la versatilidad que deberían tener las varias instalaciones, problema muy frecuente en oficinas, bancos, centros de cálculo, etc. La añadidura imprevista o el desplazamiento de un lugar de trabajo, así como el desplazamiento de un punto de luz o de un teléfono creaban problemas que se resolvían con una serie de incomodidades considerables y con costes bastante altos. El pavimento sobreelevado soluciona definitivamente toda dificultad relacionada con desplazamientos, intervenciones de mantenimiento y añadidura de puestos de trabajo sin crear problemas y reduciendo drásticamente la duración de la intervención. Como consecuencia de todo ello, el pavimento sobreelevado en poco tiempo acaba por resultar más económico que el suelo tradicional.

ФАЛЬШПОЛЫ ДЛЯ ПОМЕЩЕНИЙ

Фальшпол появился на свет для удовлетворения двух характеристик зданий, которые при использовании традиционных решений противоречат друг другу: неизменность конструкций здания, с одной стороны, а с другой - гибкость и взаимозаменяемость, которыми должны обладать различные системы, что очень важно, в особенности в офисах, банках, вычислительных центрах и т.д. Непредусмотренное расширение и перенос рабочего места, перенос светильника или же телефона создавал ряд проблем, которые приводили к различным неудобствам и довольно высоким затратам. Фальшпол окончательно решает любую проблему, связанную с переносом, обслуживанием и расширением, не вызывая неудобств, резко снижая время на выполнение работ, в кратчайшие сроки становясь более экономичным, чем традиционный пол.

PANNELLI PER PAVIMENTI SOPRAELEVATI

Tecnicamente, il pavimento sopraelevato è formato da pannelli, di dimensione 60x60, bordati e fugati, che poggiano su una struttura di acciaio ad altezza variabile, la quale forma una sorta di "spazio tecnico nascosto", sempre disponibile, nel quale alloggiare impianti elettrici, tubature, cavi telefonici, aria condizionata, riscaldamento e qualsiasi altro servizio.

Ogni pannello è semplicemente appoggiato, per cui il pavimento è ispezionabile in qualsiasi punto sollevando semplicemente i pannelli. I collegamenti degli impianti con i locali sono realizzati mediante fori e relative torrette, griglie per il passaggio di aria. Si possono realizzare gradini singoli o multipli, rampe, battute di tamponamento. L'altezza minima del pavimento finito, rispetto al piano di appoggio, è di 7/8 centimetri circa, per cui la soluzione del pavimento sopraelevato è solitamente praticabile anche nel caso di sovrapposizione su pavimentazioni esistenti.

PANNELLI PER PAVIMENTI SOPRAELEVATI

Technically, cavity floors are formed of 60x60 grouted and bordered panels resting on a variable height steel frame, which forms a concealed technical space, always available for housing electrical systems, tubing, phone cables, air conditioning and heating equipment and any other type of service. Each panel is simply resting on the frame, and can be lifted up at any time to inspect the underlying cavity at any point. The connections of the plant with the rooms is via holes, terminals, and air grilles. Single and multiple steps can be built, as can ramps and stoppers. The minimum height of the finished floor over the supporting surface is around 7/8 centimetres, so that the cavity floor solution is perfectly practical even if installed over existing flooring.

PANNEAUX POUR PLANCHERS SURÉLEVÉS

Au point de vue technique, le plancher surélevé se compose de panneaux 60x60 cm avec bords et joints, posés sur une structure en acier de hauteur variable qui, à son tour, forme une sorte de « vide technique caché », toujours disponible, dans lequel dissimuler le matériel électrique, les canalisations, les câbles de téléphone, la climatisation, le chauffage et tout autre équipement. Déposé tout simplement sur la structure, chaque panneau se retire facilement pour que le plancher soit contrôlable à n'importe quel endroit. Les connexions entre l'équipement sous-jacent et les locaux se font par des boîtes de sol et passe-câbles, et par les grilles d'aération. Il est possible de réaliser des marches simples ou multiples, des rampes, des jouées d'arrêt. La hauteur du plancher fini, par rapport à la surface d'appui, est d'environ 7/8 centimètres. Le plancher surélevé est, par conséquent, également une solution parfaitement adaptée en cas de superposition sur planchers existants.

PLATTEN FÜR DOPPELBÖDEN

Technisch gesehen besteht ein Doppelboden aus Platten in der Größe 60x60 cm mit Rand und Fuge, die auf einer Stahltragstruktur in unterschiedlicher Höhe aufliegen. Dadurch entsteht ein jederzeit zugänglicher „Technikraum“, in dem elektrische Anlagen, Rohrleitungen, Telefonkabel, Klimaanlage- und Heizungselemente und jegliche sonstigen technischen Anlagen untergebracht werden können. Jede Platte ist nur aufgelegt. Der Bodenbelag ist daher leicht an jedem Punkt inspektionierbar, denn die Platten können einfach angehoben werden. Die Anlagenanschlüsse in den Räumen erfolgen mithilfe von Bohrlochern und entsprechenden Stützlagern und es werden Lüftungsgitter vorgesehen. Es besteht die Möglichkeit zur Herstellung einzelner oder mehrerer Treppenplatten, Rampen und Raumabschlüssen. Die Mindesthöhe für den fertigen Bodenbelag beträgt in Bezug auf die Auflagefläche ca. 7-8 cm. Deshalb kann ein Doppelboden in der Regel auch auf bereits vorhandenen Bodenbelägen montiert werden.

PANELES PARA PAVIMENTOS SOBREELEVADOS

Técnicamente, el pavimento sobreelevado está formado por paneles de 60 x 60 cm, dotados de bordes y juntas, que se apoyan sobre una estructura de acero de altura variable, para configurar una especie de "espacio técnico oculto", siempre disponible, en el que alojar instalaciones eléctricas, tuberías, cables telefónicos, conductos de aire acondicionado, calefacción y cualquier otro servicio. Los paneles se colocan dejándolos apoyados, por lo que el pavimento se puede inspeccionar en cualquier punto simplemente levantando la placa o las placas correspondientes. Los sistemas de agua, luz, gas, etc. se conectan con los locales mediante orificios y torretas, así como a través de rejillas para el paso del aire. Se pueden crear escalones sencillos o múltiples, rampas y paneles de cierre. La altura mínima del pavimento terminado, con respecto a la superficie de apoyo, es de unos siete u ocho centímetros, por lo que la solución del pavimento sobreelevado resulta factible casi siempre, incluso en los casos en los que se tenga que superponer a pavimentaciones ya existentes.

ПАНЕЛИ ДЛЯ ФАЛЬШПОЛОВ

С технической точки зрения фальшпол состоит из панелей размером 60x60 см с окантовкой и заделкой швов, которые держатся на стальной конструкции с изменяющейся высотой, образующей своего рода скрытое и всегда доступное технологическое пространство, в котором располагаются электрические системы, трубы, телефонные кабели, система кондиционирования, отопления и любые другие инженерные системы. Каждая панель просто уложена, поэтому, пол можно осматривать в любой точке, для чего нужно всего лишь поднять панели. Выводы систем в помещения осуществляются через отверстия и соответствующие возвышения или решетки для прохода воздуха. Можно изготовлять одиночные ступени или же лестницы, пандусы, закрывающие элементы. Минимальная высота готового пола по сравнению с опорной поверхностью составляет около 7-8 сантиметров, поэтому, настил фальшполов, как правило, может осуществляться также и при наличии старого пола.



MATERIALE CERAMICO

Ceramic material
Matériau céramique
Keramikbelag
Material cerámico
Керамический материал

STRATO LEGANTE

Binding layer
Couche liante
Bindeschicht
Capa adhesiva
Связующий слой

PANNELLO PORTANTE

Bearing panel
Panneau porteur
Trägerplatte
Panel de sostén
Несущая панель

BARRIERA ANTIVAPORE

(foglio di alluminio)
Vapour barrier (aluminium sheet)
Pare-vapeur (feuille d'aluminium)
Wasserdampfbarriere (aluminiumfolie)
Barrera antivapor (hoja de aluminio)
Парозащитный барьер (алюминиевый лист)

STRUTTURA DI SOSTEGNO IN ACCIAIO

Steel frame
Structure de support en acier
Stützkonstruktion aus stahl
Estructura de sostén de acero
Стальная опорная конструкция.



STRUTTURA PORTANTE

La struttura portante è costituita da piedini di altezza variabile da 3/4 cm ad oltre 1 metro. La parte superiore è formata da 4 oppure 8 razze alle quali incastrare e bloccare i traversi, sempre di acciaio, che servono per meglio appoggiare i pannelli, inoltre danno la misura precisa per il distanziamento dei piedini. Esistono varie sezioni dei traversi, inoltre è possibile, per aumentare la resistenza ai carichi del pavimento, inserire anche ulteriori traversi diagonali. La parte superiore dei piedini e dei traversi è bordata con gomma antistatica, avente la funzione di assorbire gli scricchiolii e le vibrazioni.



BEARING FRAME

The frame is composed of feet which can be adjusted from 3/4 cm to over 1 metre. The upper section is composed of 4 or 8 spokes which lock into the steel beams which in turn support the panels and precisely space the feet. There are a variety of beam sections, and diagonal beams can be added to increase the floor's load bearing capacity. The top of the feet and beams is bordered with anti-static rubber, which absorbs creaks and vibrations.

STRUCTURE PORTEUSE

La structure porteuse se compose de plots de hauteur variable, de 3/4 cm à plus de 1 mètre. La partie supérieure compte 4 ou 8 crans dans lesquels encastrent et bloquent les traverses, en acier également, qui servent à optimiser l'appui des panneaux, ainsi qu'à définir précisément l'espacement entre les plots. Il existe plusieurs types de traverses. Pour augmenter la résistance à la charge du plancher, des traverses diagonales peuvent aussi être ajoutées. La partie supérieure des plots et des traverses présente un bord en caoutchouc antistatique pour absorber les craquements et les vibrations.

TRAGKONSTRUKTION

Die Tragkonstruktion besteht aus Bodenstützen mit verstellbarer Höhe von 3/4 cm bis über 1 m. Der obere Bereich besteht aus 4 oder 8 Speichen, an denen die ebenfalls aus Stahl bestehenden Querträger fixiert werden. Auf die Querträger werden die Platten aufgelegt; sie geben zudem den Abstand für die Bodenstützen vor. Die Querträger sind mit unterschiedlichen Querschnitten erhältlich. Die Belastbarkeit des Bodenbelags kann durch Einsetzen weiterer, diagonaler Querträger zusätzlich erhöht werden. Der obere Bereich der Bodenstützen und Querträger hat einen Rand aus antistatischem Gummi, der zur Schall- und Vibrationsdämmung dient.

ESTRUCTURA DE SOSTÉN

La estructura de sostén está constituida por unos pies con una altura variable de tres o cuatro centímetros a más de un metro. La parte superior está formada por cuatro u ocho radios a los que encajar y fijar los travesaños, también de acero, que ayudan a formar una base sobre la que apoyar los paneles; además, brindan la medida exacta para el distanciamiento de los pies. Existen varias secciones de travesaños; además se puede aumentar la resistencia del pavimento a las cargas agregando más travesaños diagonales. La parte superior de los pies y de los travesaños está revestida a lo largo de los bordes con goma antiestática, que tiene la función de amortiguar y reducir rechinchamientos y vibraciones.

НЕСУЩАЯ КОНСТРУКЦИЯ

Несущая конструкция состоит из ножек высотой от 3-4 см до более 1 метра. Верхняя часть состоит из 4 или из 8 спиц, к которым крепятся и блокируются поперечины, также выполненные из стали, необходимые для лучшей укладки панелей. Кроме того, они задают точный размер для установки ножек. Поперечины могут иметь разное сечение, кроме того, для повышения выдерживаемой полом нагрузки можно установить дополнительные диагональные поперечины. Верхняя часть ножек и поперечин окантована антистатической резиной, задачей которой является устранение скрипа и вибрации.

PANNELLO PORTANTE

Il pannello portante è formato da una anima centrale di 3-4 cm che può essere di legno truciolare ad alta o altissima densità, oppure inerti e resine, che determina le caratteristiche di resistenza (ai carichi ed al fuoco) del pavimento. Tutti i tipi di pannello vengono bordati inferiormente con un foglio di alluminio che protegge dall'umidità e vengono bordati perimetralmente in gomma. Il materiale ceramico di finitura viene incollato, fugato e bordato intorno al pannello con resine poliuretaniche. Si possono utilizzare tutti i grandi formati (lo standard prevede la misura di 60 cm).

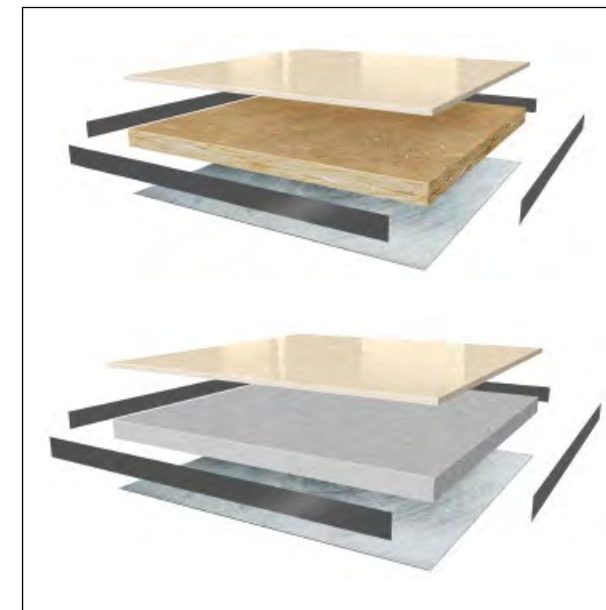

BEARING PANEL

The bearing panel is composed of core of 3-4 cm which can be made of high or very high density wood chipping, or aggregate and resin, and which determines the panel's mechanical strength and resistance to fire. All types of panels are bordered underneath with an aluminium sheet which protects against humidity and are bordered around their edges with rubber. The finishing ceramic layer is glued, grouted and bordered around the panel with polyurethane resin. All large formats are available (the standard one being 60 cm).

PANNEAU PORTEUR

Le panneau porteur se compose d'une âme centrale de 3-4 cm qui peut être en particules de bois à haute ou à très haute densité, ou en matériaux inertes et résines. Celle-ci détermine les caractéristiques de résistance (à la charge et au feu) du plancher. Quel qu'en soit le type, les panneaux comportent, dans le bas, un bord en feuille d'aluminium pour la protection contre l'humidité et, autour, un bord en caoutchouc. La matière céramique de finition est collée sur le panneau, jointoyée et entourée de résines polyuréthanes. Tous les grands formats peuvent être utilisés (mesure standard 60 cm).

TRÄGERPLATTE

Die Trägerplatte besteht aus einer 3-4 cm starken Spanplatte mit hoher oder sehr hoher Dichte oder aus Inertmaterial und Harz, welche die jeweiligen Festigkeitseigenschaften (Tragfähigkeit und Brandfestigkeit) des Bodenbelags bestimmt. Alle Trägerplattenarten werden an der Unterseite mit Aluminiumfolie versehen, die vor Feuchtigkeit schützt, und erhält eine Gummiumrandung an der Außenkante. Der Oberbelag aus Keramik wird an der Trägerplatte mit Polyurethanharzen verklebt, verfugt und mit einem Rand versehen. Sämtliche Großformate sind verwendbar (das Standardmaß sind 60 cm).

PANEL DE SOSTÉN

El panel de sostén está formado por un alma central de tres o cuatro centímetros, y es de conglomerado de alta o muy alta densidad o bien de materiales inertes y resinas, que determinan las características de resistencia (a las cargas y al fuego) del pavimento. Todos los tipos de panel presentan bordes revestidos con hoja de aluminio en su parte inferior, para protegerlos de la humedad, y con goma en su perímetro. El material cerámico de acabado es encolado, dotado de juntas y revestido a lo largo de su borde, alrededor de todo el panel, con resinas poliuretánicas. Se pueden utilizar todos los formatos grandes (el formato estándar mide 60 cm).

НЕСУЩАЯ ПАНЕЛЬ

Несущая панель состоит из сердечника толщиной 3-4 см, который может быть выполнен из ДСП высокой или очень высокой плотности, или же из наполнителей и смол, что определяет характеристики стойкости пола (к нагрузкам и огню). Панели всех типов покрываются снизу алюминиевой фольгой, которая защищает от влаги, а по периметру они окантовываются резиной. Отделочный керамический материал наклеивается, заделывается и герметизируется по периметру панели полиуретановой смолой. Можно использовать все большие форматы (стандартный размер - 60 см).

PAVIMENTI SOPRAELEVATI ESTERNI

Utilizzando lo spessore 20mm delle superfici Emilgroup, è possibile realizzare pavimentazioni sopraelevate in qualsiasi contesto di progettazione outdoor, operando in maniera semplice, veloce e sicura sulle strutture preesistenti, senza la necessità di effettuare interventi edilizi particolarmente onerosi. Essendo basate su sistemi modulari e regolabili, tali applicazioni permettono di realizzare pavimenti uniformi e stilisticamente ricercati che portano in dote numerosi vantaggi tecnici e logistici. Tra i principali:

- l'eliminazione dei problemi di umidità, infiltrazione di acqua e difficoltà di deflusso
- un migliore isolamento termico e acustico
- una elevata resistenza ai carichi e alle sollecitazioni
- una riduzione del peso della pavimentazione sulla struttura di appoggio
- un'ottima capacità di assorbimento delle dilatazioni e dei movimenti strutturali
- la creazione di un vano tecnico tra le superfici calpestabili e la struttura sottostante, per l'alloggiamento di cavi, tubi e altri tipi di impianti nascosti alla vista, ma al contempo facilmente ispezionabili ed eventualmente riparabili
- l'utilizzo di materiali completamente riusabili e riciclabili, nel massimo rispetto dei principi di circolarità e sostenibilità ambientale.



OUTDOOR CAVITY FLOORS

Emilgroup surfaces in the 20 mm thickness are the quick, easy, safe way of constructing raised pavings on top of existing surfaces in any outdoor location, with no need for particularly expensive building works. Since they are based on modular, adjustable systems, these applications can create uniform pavings of immaculate appearance, with a large number of technical and logistical benefits. Chief amongst them:

- elimination of damp, water infiltration and drainage problems
- improved heat insulation and soundproofing
- excellent resistance to loads and stresses
- reduction in paving weight to be borne by supporting structure
- excellent capability for absorbing expansion/contraction and structural settlement
- the creation of a technical cavity between the top surface and the underlying structure, to accommodate wiring, pipes and any other systems in a concealed position which is still easily accessible for inspection and any repairs
- the use of completely reusable, recyclable materials, in full compliance with principles of circularity and environmental sustainability.

PLANCHERS SURÉLEVÉS EXTÉRIEUR

Avec les surfaces Emilgroup de 20 mm d'épaisseur, il est possible de réaliser des planchers surélevés dans tous les contextes extérieurs en intervenant de manière simple, rapide et sûre, sur les structures existantes, sans travaux particulièrement onéreux. Basées sur des systèmes modulaires et réglables, ces applications forment des revêtements de sol uniformes et stylistiquement sophistiqués qui comportent d'innombrables avantages techniques et logistiques, dont entre autres :

- suppression des problèmes d'humidité, d'infiltration et d'écoulement des eaux ;
- optimisation du calorifugeage et de l'insonorisation ;
- très grande résistance aux charges et contraintes ;
- diminution du poids du revêtement de sol sur le support ;
- excellente capacité d'absorption des dilatations et des mouvements structurels ;
- création d'un vide technique entre les surfaces de piétement et la structure sous-jacente pour y dissimuler les câbles, tuyaux et autres équipements qui restent, néanmoins, facilement contrôlables et, le cas échéant, réparables ;
- utilisation de matériels totalement réutilisables et recyclables selon les principes de l'économie circulaire et du développement durable.

DOPPELBÖDEN FÜR AUSSENBEREICH

Bei Verwendung der 20 mm starken Oberflächen von Emilgroup können in jeder Umgebung Doppelböden für Projekte im Außenbereich hergestellt werden. Die Arbeiten dazu sind einfach, schnell und sicher und erfolgen auf den bereits bestehenden Strukturen, ohne dass besonders aufwendige Bauarbeiten erforderlich sind. Da es sich um modulare und verstellbare Systeme handelt, können damit einheitliche und stilistisch edle Fußböden hergestellt werden, die zahlreiche technische und logistische Vorteile zu bieten haben. Die wichtigsten Vorteile:

- keine Probleme mit Feuchtigkeit, eindringendem Wasser oder Staunässe
- verbesserte Wärme- und Schalldämmung
- hohe Widerstandsfähigkeit gegen Lasten und Belastungen eduziertes Gewicht des Fußbodens auf der Auflagefläche
- hervorragende Absorbierung von Ausdehnung und strukturellen Bewegungen
- Schaffung eines technischen Raums zwischen der Trittläche und der darunterliegenden Struktur, in dem Kabel, Schläuche und andere Anlagen untergebracht werden können, die nicht zu sehen, aber leicht zu kontrollieren und ggf. zu reparieren sein sollen
- Einsatz von vollständig wieder verwendbarem und recycelbarem Material in Einhaltung des Kreislauf- und Nachhaltigkeitsprinzips.

PAVIMENTOS SOBREELEVADOS PARA EXTERIORES

Gracias al grosor de 20 mm de las superficies de Emilgroup se pueden llevar a cabo pavimentaciones sobreelevadas en cualquier contexto proyectivo al aire libre, actuando de manera sencilla, rápida y segura sobre las estructuras ya existentes, sin tener que efectuar obras particularmente costosas. Al estar basadas en sistemas modulares y regulables, tales aplicaciones permiten disponer pavimentos uniformes y estéticamente sofisticados que conllevan numerosas ventajas técnicas y logísticas, entre las que cabe destacar:

- la eliminación de todo problema de humedad, filtraciones de agua y dificultades de desagüe;
- un mejor aislamiento térmico y acústico;
- una elevada resistencia a las cargas y sollicitaciones;
- una reducción del peso de la pavimentación sobre la estructura en la que se coloca;
- una excelente capacidad de absorción de las dilataciones y los movimientos estructurales;
- la creación de un hueco técnico entre las superficies transitables y la estructura subyacente para el alojamiento de cables, tubos y demás instalaciones ocultas a la vista, pero al mismo tiempo fácilmente inspeccionables y reparables, si resulta necesario;
- el empleo de materiales completamente reutilizables y reciclables, respetando al máximo los principios de circularidad y sostenibilidad medioambiental.

ФАЛЬШПОЛЫ ДЛЯ ЭКСТЕРЬЕРОВ

Благодаря материалам Emilgroup толщиной 20 мм можно изготавливать фальшполы в любых условиях проектирования наружных пространств, выполняя работы просто, быстро и безопасно на уже существующих конструкциях, без необходимости выполнения достаточно затратных строительных работ. Основываясь на модульных и регулируемых системах, эти применения позволяют настлать однородные полы в изысканном стиле, обладающие многочисленными техническими и логистическими преимуществами. Основными из них являются:

- устранение проблем, связанных с влажностью, просачиванием воды и сложностями ее отвода
- лучшая тепловая и звуковая изоляция
- высокая стойкость к нагрузкам и воздействию
- снижение веса пола, лежащего на опорной конструкции
- отличная способность поглощать расширения и структурные подвижки
- создание технологического пространства между поверхностью для хождения и находящейся под ней конструкцией для прокладки кабелей, труб и других типов скрытых систем, но при возможности их быстрого осмотра и ремонта в случае необходимости.
- применение материалов, подлежащих полному повторному использованию, максимально соблюдая принципы обращения и экологической рациональности.

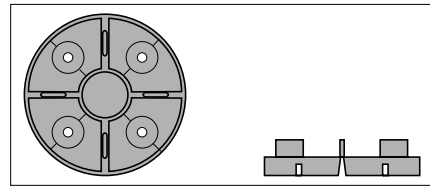

SUPPORTI FISSI

Fixed pedestals
Plots fixes
Feststehende Bodenstützen
Fijos
Фиксированные опоры

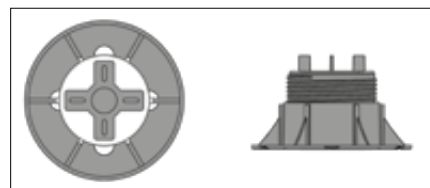

SUPPORTI REGOLABILI IN ALTEZZA

Adjustable-height pedestals
Plots réglables en hauteur
Höhenverstellbare Bodenstützen
De altura graduable
Опоры с регулировкой по высоте

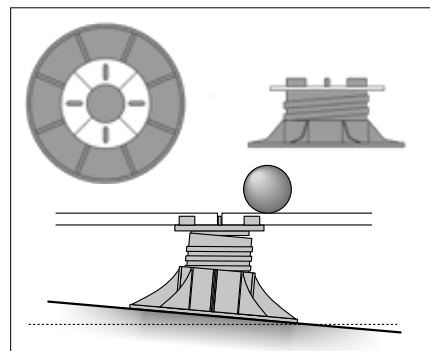

SUPPORTI REGOLABILI IN ALTEZZA AUTOLIVELLANTI

Self-levelling adjustable-height pedestals
Plots autonivelants réglables en hauteur
Höhenverstellbare Selbstnivellierende Bodenstützen
De altura graduable autonivelantes
Самовыравнивающиеся опоры с регулировкой по высоте

I SUPPORTI

I supporti hanno una funzione di sostegno e possiedono un'elevata resistenza meccanica.

Sono realizzati prevalentemente in materiale riciclabile e riciclato, resistono a soluzioni acide e basiche, agli agenti atmosferici ed a temperature da -30° a + 120°.

I supporti per esterno sono concepiti per essere regolabili in altezza e prevedono accessori che consentono la correzione di pendenza fino ad un massimo del 5%.

I supporti si distinguono nelle seguenti tipologie:

- SUPPORTI FISSI
- SUPPORTI REGOLABILI IN ALTEZZA
- SUPPORTI REGOLABILI IN ALTEZZA AUTOLIVELLANTI

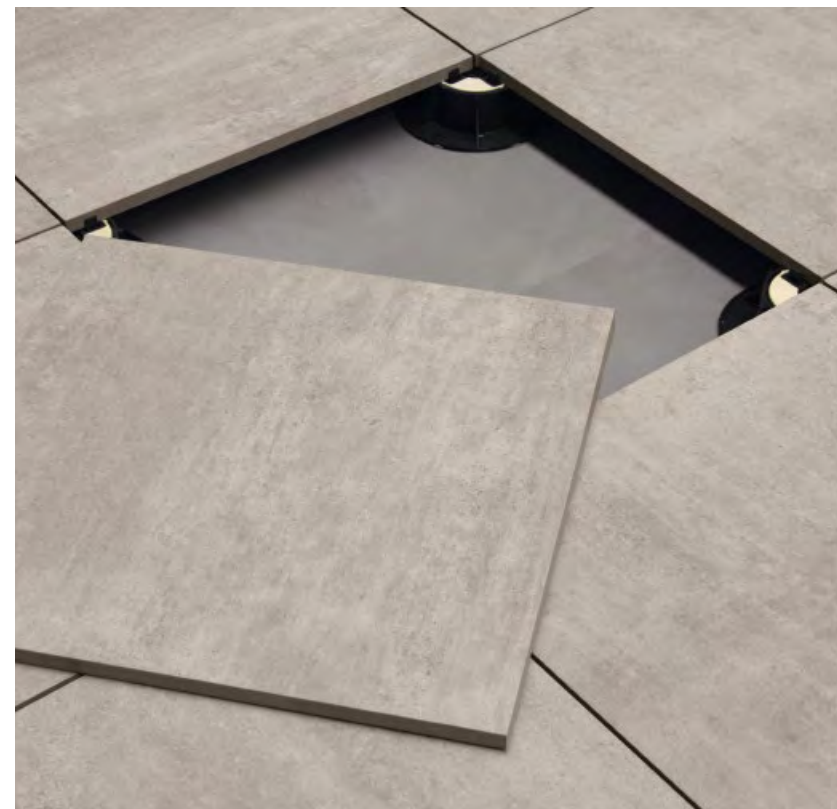

THE PEDESTALS

The pedestals support the paving and have excellent mechanical strength. They are mainly made from recyclable and recycled material and withstand acid and base solutions, weather and temperatures from -30° to +120°.

Outdoor pedestals are designed to be height-adjustable and have accessories which allow correction of the gradient up to a maximum of 5%.

The pedestals are divided into the following types:

- Fixed pedestals
- Adjustable-height pedestals
- Self-levelling adjustable-height pedestals

LES PLOTS

Les plots servent à soutenir et possèdent une très grande résistance mécanique.

Ils sont fabriqués principalement en matière recyclable et recyclée, résistent aux acides et bases, aux agents atmosphériques et à des températures de -30 ° à + 120 °C. Les plots pour extérieur sont réglables en hauteur et ils s'accompagnent d'accessoires permettant la correction d'inclinaison jusqu'à un maximum de 5 %.

Il existe les types de plots ci-après :

- Plots fixes
- Plots réglables en hauteur
- Plots autonivelants réglables en hauteur

BODENSTÜTZEN

Die Bodenstützen dienen als Träger und besitzen hohe mechanische Festigkeit.

Sie sind hauptsächlich aus recyclingfähigen Werkstoffen und Recyclingmaterialien hergestellt, säure- und laugenbeständig, witterungsbeständig und resistent gegenüber Temperaturen von -30° bis +120°.

Die Bodenstützen für Außenbereiche sind höhenverstellbar und sehen Zubehör vor, mit dem die Neigung bis zu maximal 5 % verstellt werden kann. Folgende Arten von Bodenstützen sind erhältlich:

- Feststehende Bodenstützen
- Höhenverstellbare Bodenstützen
- Höhenverstellbare Selbstnivellierende Bodenstützen

SOPORTES

Los soportes tienen una función de sostén y poseen una elevada resistencia mecánica.

Están constituidos sobre todo por material reciclable y reciclado, son resistentes a ácidos y bases, a los agentes atmosféricos y a temperaturas de -30 a +120 °C. Los soportes para exterior están concebidos para que se pueda graduar su altura y prevén accesorios que permiten corregir pendientes hasta un máximo del 5%.

Existen soportes de los tipos siguientes:

- Fijos
- De altura graduable
- De altura graduable autonivelantes

ОПОРЫ

Опоры выполняют несущую функцию и обладают высокой механической прочностью.

Они состоят главным образом из переработанного материала, подлежащего дальнейшей переработке. Они выдерживают воздействие кислотных и щелочных растворов, атмосферное воздействие и температуру от -30° до + 120°.

Опоры для наружных работ имеют возможность регулировки по высоте и предусматривают аксессуары, позволяющие корректировать высоту вплоть до 5% максимум.

- Опоры могут быть следующих типов:
- Фиксированные опоры
 - Опоры с регулировкой по высоте
 - Самовыравнивающиеся опоры с регулировкой по высоте

SVILUPPO DEI SUPPORTI

Tutti i prodotti Emilgroup con uno spessore di 20 mm sono adatti per essere installati su pavimenti sopraelevati per esterno.

L'installazione deve essere eseguita con il numero adeguato di piedistalli in base alle dimensioni della piastrella (vedi tabella seguente).

Formato Size Format Format Tamaño Формат	N° supporti per piastrella No. pedestals per tile Nbre de plots par dalle Anz. Bodenstützen pro Platte N° de soportes por placa Кол. опор на плитку		N° supporti per mq No. pedestals per SqM Nbre de plots par m² Anz. Bodenstützen pro qm N° de soportes por metro cuadrado Кол. опор на кв.м.
60x60 cm - 24"x24" (nominal)	4		2,78
45x90 cm - 18"x36" (nominal)	6		4,94
40x120 cm - 16"x48" (nominal)	6		4,17
60x120 cm - 24"x48" (nominal)	6		2,78
80x80 cm - 24"x48" (nominal)	5		6,25
50x100 cm - 24"x48" (nominal)	6		4

PEDESTAL LAYOUTS

All Emilgroup products 20 mm thick are suitable for installation on outdoor raised paving systems.

A number of pedestals appropriate to the size of the tiles must be used for installation (see table).

CONCEPTION DES PLOTS

Tous les produits Emilgroup de 20 mm d'épaisseur peuvent être posés en extérieur sur des planchers surélevés.

Le nombre de plots doit être calculé en fonction des dimensions du carreau (voir tableau).

AUSFÜHRUNG DER BODENSTÜTZEN

Alle Emilgroup-Produkte in der Stärke 20 mm eignen sich für die Doppelbodenmontage in Außenbereichen.

Die Installation muss mit einer für die gewählte Fliesengröße ausreichenden Anzahl von Bodenstützen ausgeführt werden (siehe Tabelle).

DESARROLLO DE LOS SOPORTES

Todos los productos de Emilgroup con un grosor de 20 mm son adecuados para su instalación sobre pavimentos sobre elevados para exterior.

La instalación debe llevarse a cabo empleando el número oportuno de pies según las medidas de la placa (ver tabla).

РАСЧЕТ ОПОР

Вся продукция Emilgroup толщиной 20 мм пригодна для настила наружных фальшполов.

Установка должна выполняться с использованием подходящего количества опор, в зависимости от размера плитки (см. таблицу ниже).

SEZIONE TECNICA

TECHNICAL INFORMATION

SECTION TECHNIQUE

TECHNISCHE ANGABEN

SECCION TÉCNICA

ТЕХНИЧЕСКИЙ РАЗДЕЛ

Proposte di posa Installation suggestions Croquis de pose Verlegungsvorschläge Sugerencias de composicion Предложения по укладке	236
---	-----

Caratteristiche tecniche generali secondo le norme General technical specifications in compliance with standards Caracteristiques techniques generales selon les normes Allgemeine technische eigenschaften nach den normen Caracteristicas tecnicas generales conformes con las normas Общие технические характеристики по нормам	241
---	-----

Certificazioni Certifications Certifications Zertifizierungen Certificaciones Сертификаты	244
--	-----

Consigli di Manutenzione Advice for Maintenance Conseil d'entretien Pflegehinweise Consejos de mantenimiento Инструкции по эксплуатации	246
--	-----

Posa Laying Pose Verlegung Composicion Укладка	253
---	-----

Destinazioni d'uso Intended uses Domaines d'application Zweckbestimmung Usos previstos Назначение	254
--	-----

Il taglio delle piastrelle in gres porcellanato Cutting porcelain stoneware tiles La decoupe des carreaux en gres cerame Schneiden von Feinsteinzeugfliesen Corte de los azulejos de gres porcelánico Резка керамогранитной плитки	255
---	-----

Condizioni generali di vendita e garanzie General conditions of sale for export and guarantees Conditions generales de vente a l'exportation et de garantie Allgemeine verkaufs - und garantiebedingungen Condiciones generales de venta y garantias Общие условия продажи и гарантии	258
--	-----

PROPOSTE DI POSA

Installation suggestions | Croquis de pose | Verlegungsvorschläge | Sugerencias de composicion | Предложения по укладке

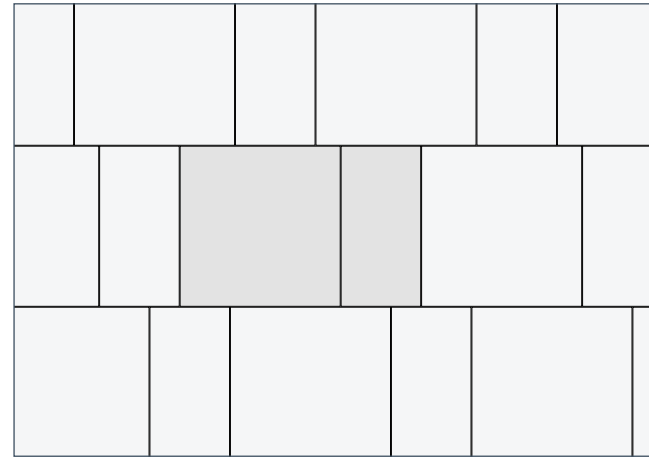

1A	60x60	66,7%	1B	80x80	66,7%
	30x60	33,3%		40x80	33,3%

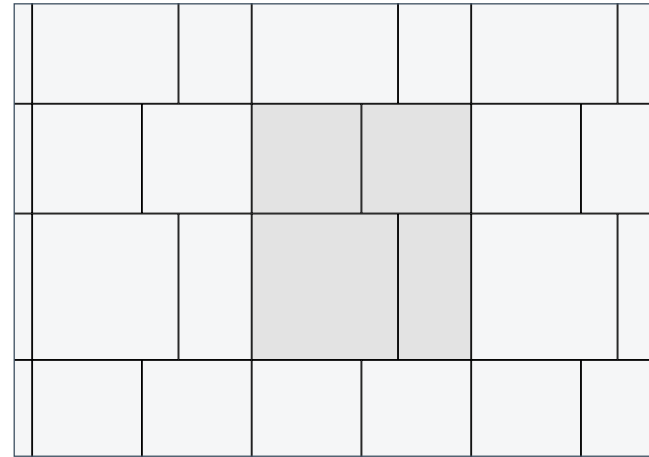

2	80x80	38,1%
	40x80	19,0%
	60x60	42,9%

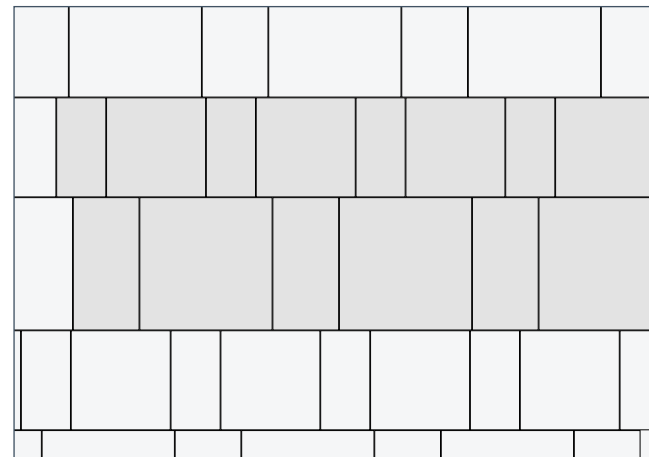

3	80x80	38,1%
	40x80	19,0%
	60x60	28,6%
	30x60	14,3%

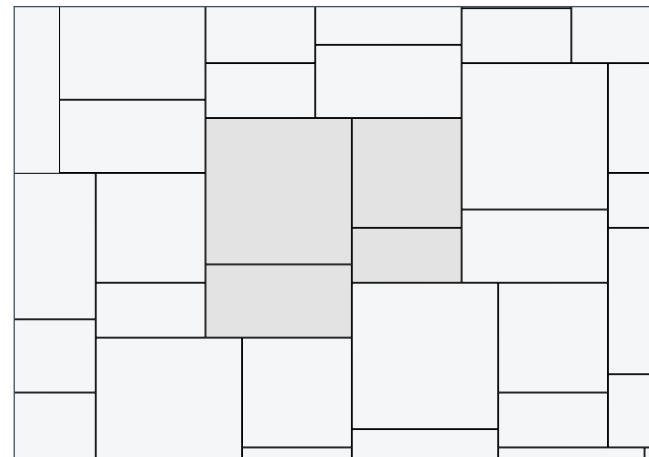

4	80x80	42,7%
	40x80	21,3%
	60x60	24,0%
	30x60	12,0%

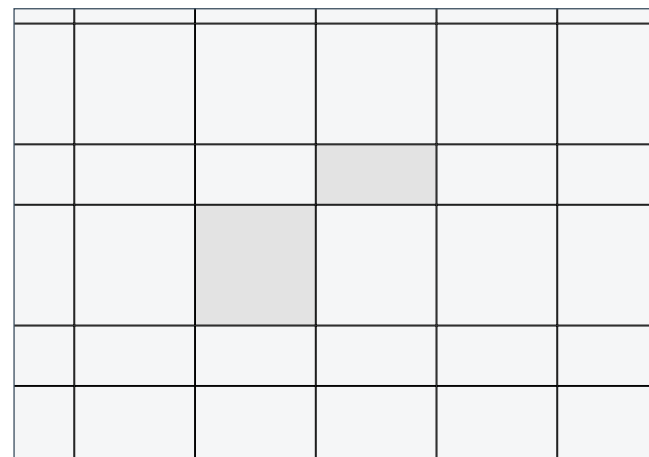

5A	60x60	66,7%	5B	80x80	66,7%
	30x60	33,3%		40x80	33,3%

PROPOSTE DI POSA

Installation suggestions | Croquis de pose | Verlegungsvorschläge | Sugerencias de composicion | Предложения по укладке

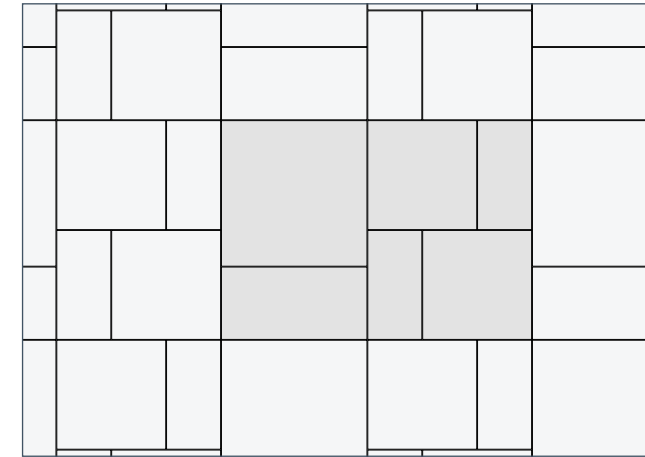

6	80x80	31,4%
	40x80	15,7%
	60x60	35,3%
	30x60	17,6%

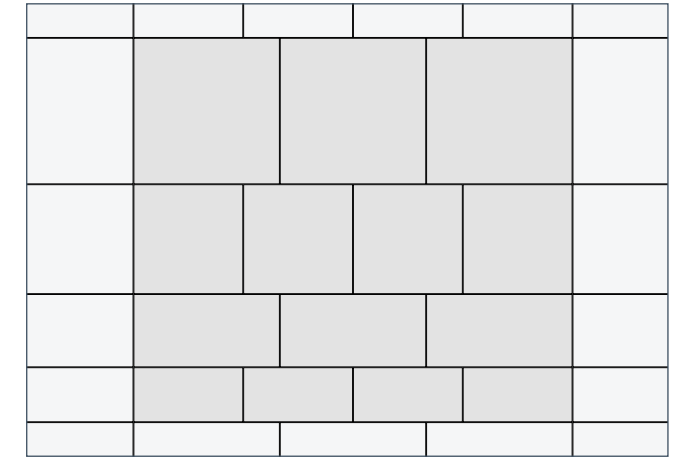

7	80x80	38,1%
	40x80	19,0%
	60x60	28,6%
	30x60	14,3%

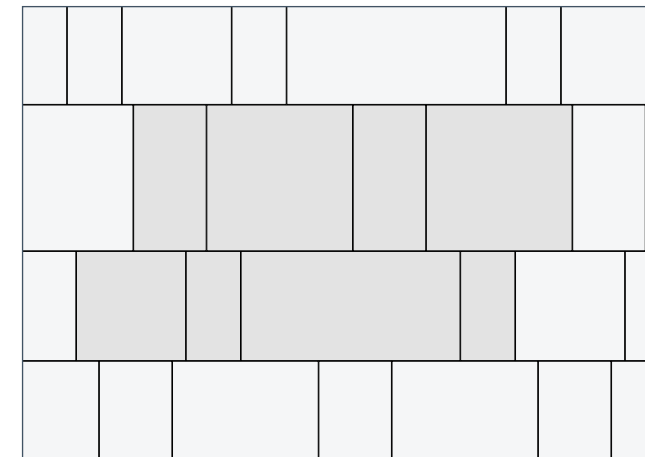

8	60x120	21,5%
	60x60	10,7%
	30x60	10,7%
	80x80	38,1%
	40x80	19,0%

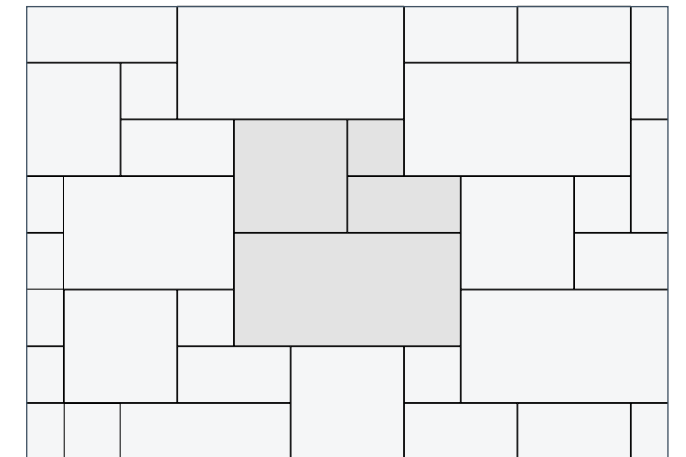

9	60x120	53,3%
	60x60	26,7%
	30x60	13,3%
	30x30	6,7%

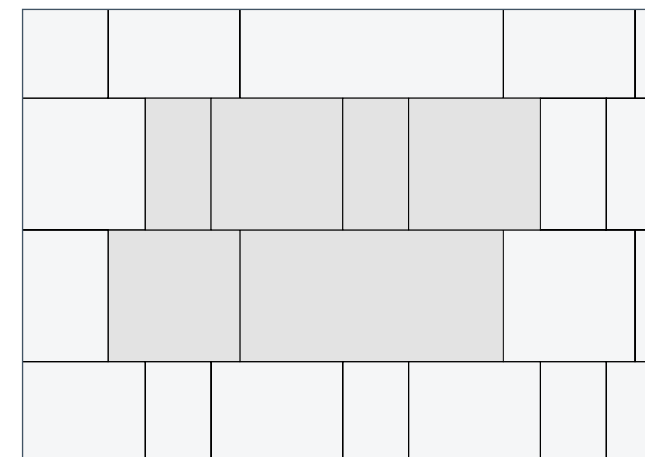

10	60x120	33,3%
	60x60	50%
	30x60	16,7%

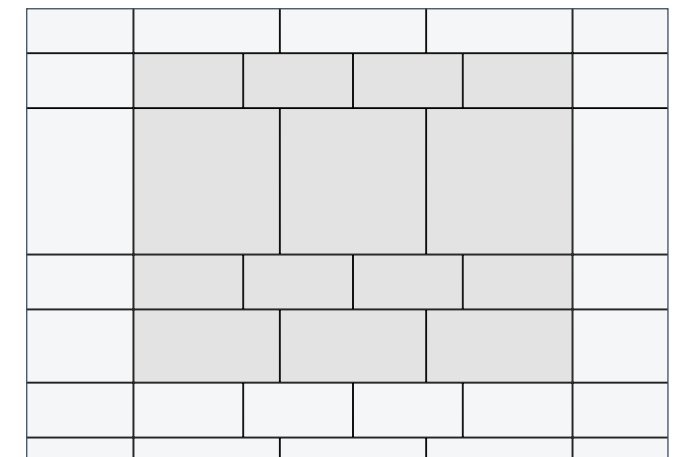

11	80x80	44,4%
	40x80	22,2%
	30x60	33,4%

PROPOSTE DI POSA

Installation suggestions | Croquis de pose | Verlegungsvorschläge | Sugerencias de composicion | Предложения по укладке

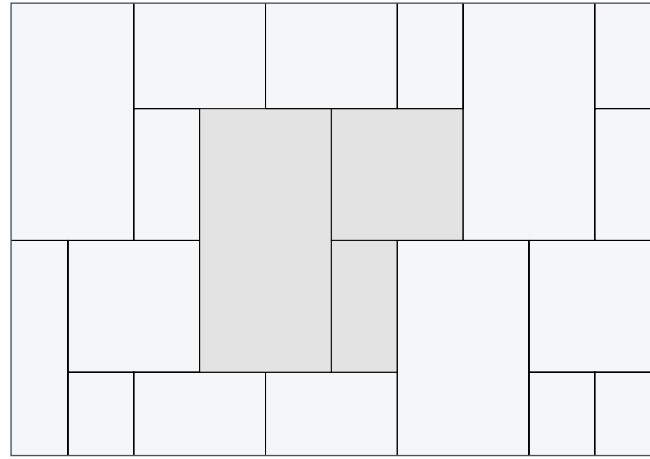

12 60x120 57,1%
60x60 28,6%
30x60 14,3%

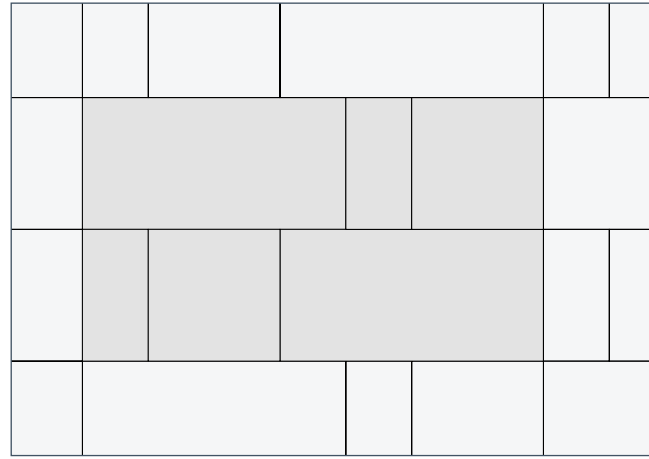

13 60x120 57,1%
60x60 28,6%
30x60 14,3%

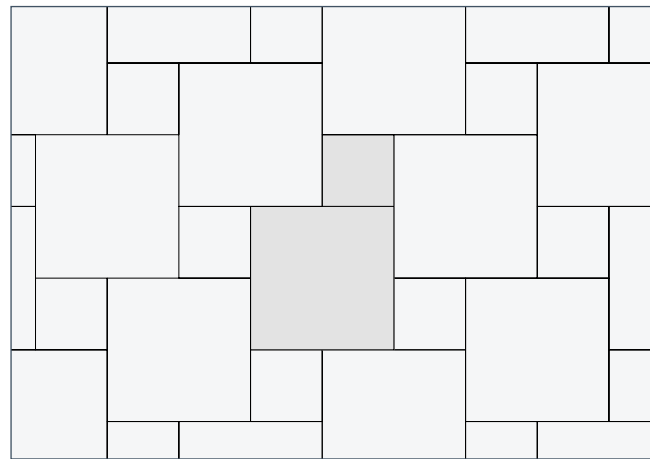

14 60x60 80,5%
30x30 19,5%

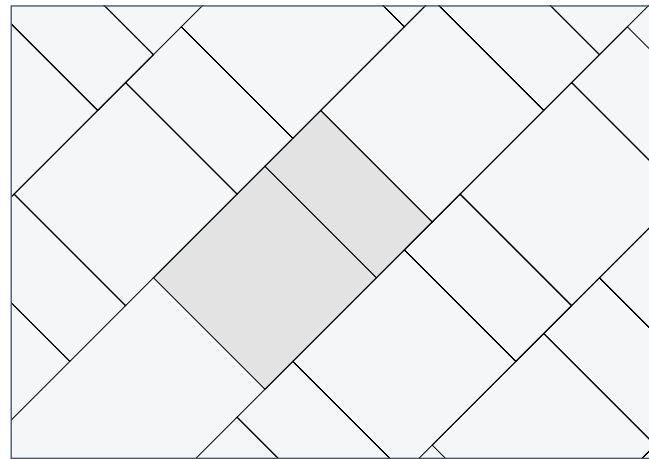

15 60x60 67%
30x60 33%

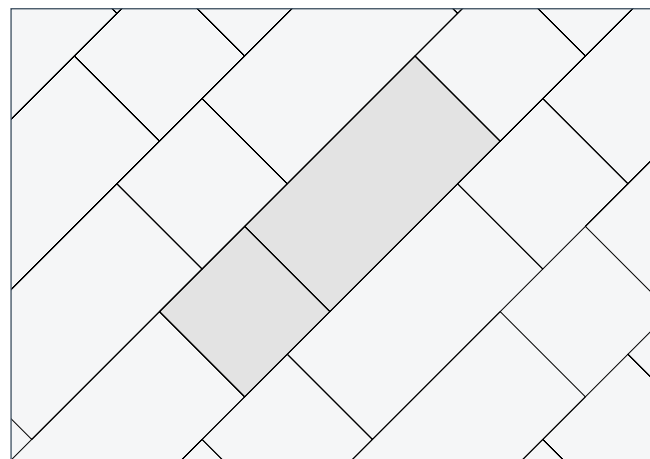

16A 60x120 66,7%
60x60 33,3%

16B 30x60 66,7%
30x30 33,3%

16C 20x40 66,7%
20x20 33,3%

PROPOSTE DI POSA

Installation suggestions | Croquis de pose | Verlegungsvorschläge | Sugerencias de composicion | Предложения по укладке

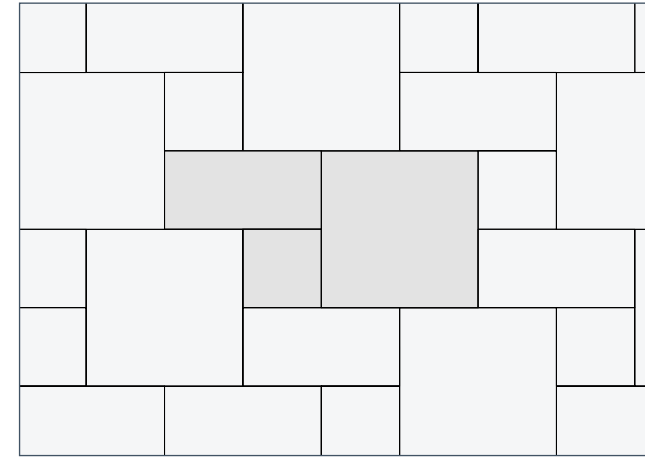

17 60x60 57,1%
30x60 28,6%
30x30 14,3%

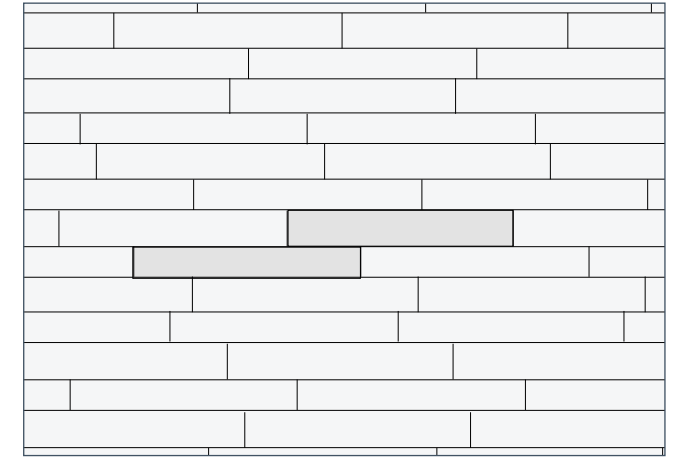

18 20x120 57,1%
15x120 42,9%

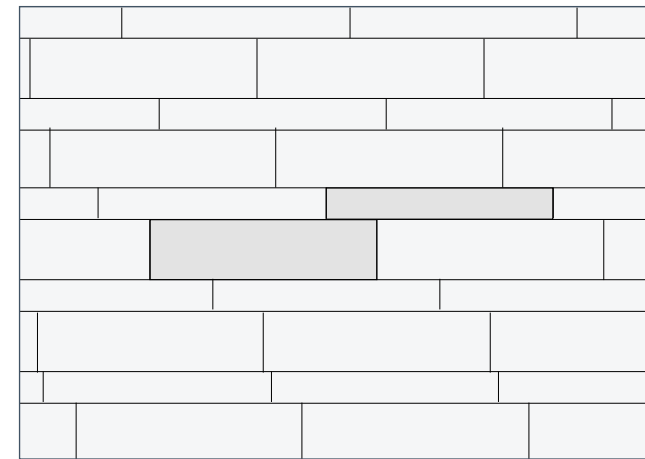

19 30x120 66,7%
15x120 33,3%

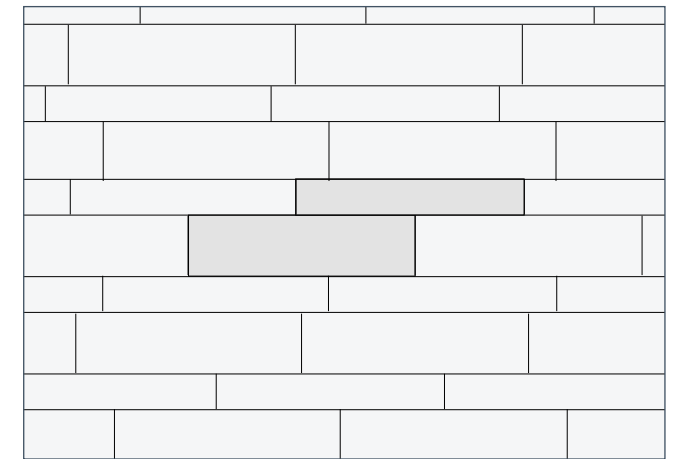

20 30x120 60,0%
20x120 40,0%



21 30x120 46,1%
20x120 30,8%
15x120 23,1%

PROPOSTE DI POSA

Installation suggestions | Croquis de pose | Verlegungsvorschläge | Sugerencias de composicion | Предложения по укладке

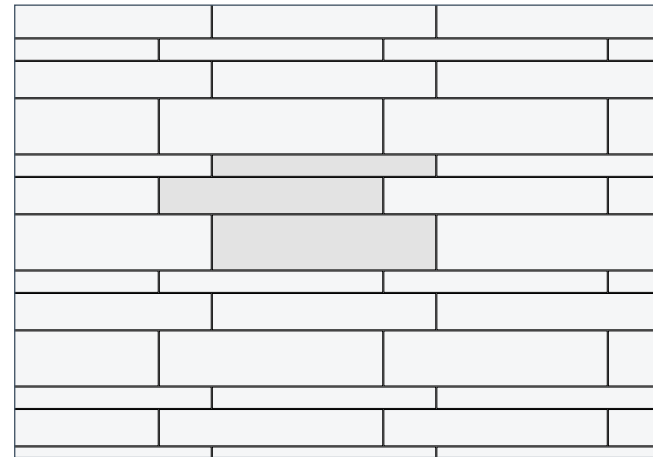

22	30x120	46,1%
	20x120	30,8%
	15x120	23,1%

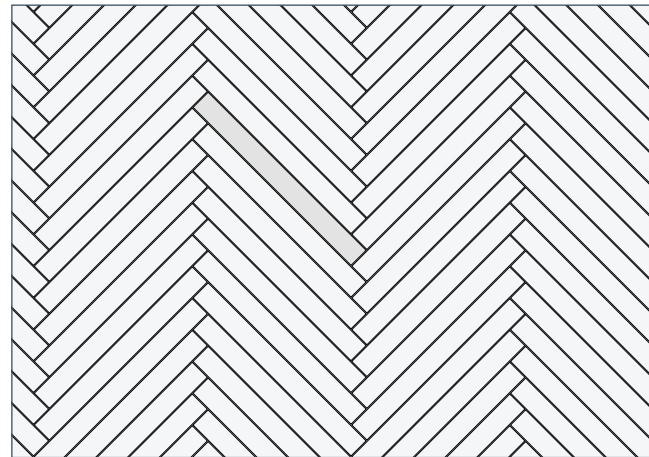

23	15x120	100,0%
-----------	---------------	--------

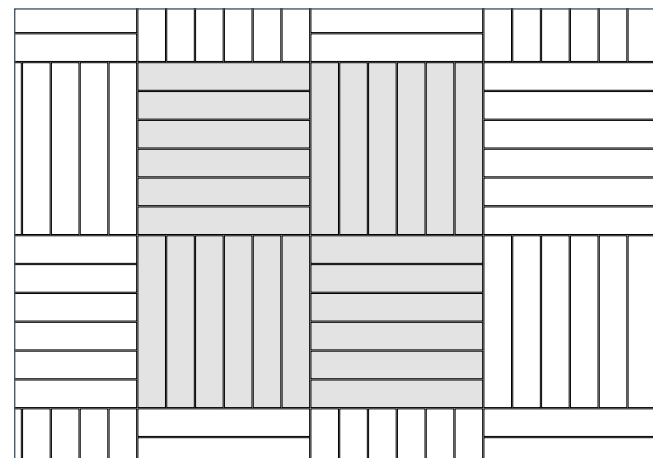

24A	15x90	100,0%	24B	20x120	100,0%
------------	--------------	--------	------------	---------------	--------

ISO 13006/UNI EN 14411 E UNI EN ISO 10545/1-16

CARATTERISTICHE TECNICHE GENERALI SECONDO LE NORME

General technical specifications in compliance with standards | Caracteristiques techniques generales selon les normes
Allgemeine technische eigenschaften nach den normen | Caracteristicas tecnicas generales conformes con las normas | Общие технические характеристики по нормам

Le norme ISO (International Organization for Standardization), sono adottate e pubblicate in tutti i paesi aderenti (oltre 150 Paesi nel mondo). La ISO 13006 classifica le piastrelle di ceramica in base al metodo di formatura e all'assorbimento d'acqua e per ciascun gruppo definisce le caratteristiche e i requisiti per le piastrelle di 1a SCELTA.

La norma EN 14411 è stata pubblicata dal CEN (Comitato Europeo di Normazione e riporta nell'appendice ZA la parte "armonizzata", che costituisce lo strumento per l'apposizione della marcatura CE, ai sensi del vigente Regolamento del Parlamento europeo per la commercializzazione dei prodotti da costruzione. La marcatura CE è obbligatoria per la circolazione delle piastrelle all'interno dell'UE, essa riguarda le piastrelle di tutte le scelte commerciali e prende in considerazione i requisiti essenziali di sicurezza in base alla destinazione d'uso dichiarata dal produttore.

Tutti i prodotti Emilceramica sono marcati CE e classificati per destinazione d'uso, in seguito al superamento delle prove iniziali e periodiche previste dalla norma UNI EN 14411 nella revisione corrente.

Le norme UNI EN ISO 10545/1-16 forniscono i metodi di prova e di campionamento, per la verifica delle caratteristiche stabilite dalla ISO 13006 e UNI EN 14411.

The ISO (International Organisation for Standardization) standards have been adopted and published in all the associated countries (over 150 countries in the world). The ISO 13006 classifies ceramic tiles according to the moulding methods and water absorption and for each group it defines the characteristics and requisites for FIRST GRADE tiles.

The EN 14411 standard was published by the CEN (European Committee for Standardization) and includes the "harmonised" part in appendix ZA, which constitutes the tool for affixing the EC mark according to the effective European Parliament regulation for the sale of construction products. The EC mark is obligatory for the circulation of tiles within the EU. This regards tiles of all grades on the market and taking into consideration the essential requirements for "safety" according to the intended use declared by the manufacturer.

All Emilceramica products are marked EC and are classified for destination of use after passing the initial and periodic tests set down in the current version of the UNI EN 14411 standard.

The UNI EN ISO 10545/1-16 standards set out the testing and sampling methods to check the characteristics prescribed by ISO 13006 and UNI EN 14411.

Les normes ISO (International Organization for Standardization) sont adoptées et publiées dans tous les pays qui y ont adhéré (plus de 150 pays dans le monde). La norme ISO 13006 classe les carreaux et dalles céramiques selon la méthode de fabrication et l'absorption d'eau, et pour chaque groupe, elle précise les caractéristiques et les qualités requises pour les carreaux de 1er CHOIX.

La norme EN 14411 a été publiée par le CEN (Comité Européen de Normalisation) et elle reprend dans l'annexe ZA la partie « harmonisée » qui est l'instrument pour l'apposition du marquage CE, aux termes du Règlement du Parlement européen pour la commercialisation des produits de construction. Le marquage CE est obligatoire pour la circulation des carreaux au sein de l'U.E. Il concerne les carreaux de tous choix commerciaux et il tient compte des exigences essentielles de sécurité en fonction de l'usage déclaré par le fabricant.

Tous les produits Emilceramica sont marqués CE et classés selon l'usage après avoir réussi les essais initiaux et les audits périodiques prévus par la version actuelle de la norme UNI EN 14411.

Les normes UNI EN ISO 10545/1-16 fournissent les méthodes d'essai et d'échantillonnage pour le contrôle des caractéristiques établies par les normes ISO 13006 et UNI EN 14411.

Die ISO-Normen (ISO - International Organization for Standardization) werden in allen Mitgliedsländern (mehr als 150 Länder) angewendet und veröffentlicht.

Die Norm ISO 13006 klassifiziert die Keramikfliesen auf der Grundlage des Formgebungsverfahrens und der Wasseraufnahme und legt für jede Gruppe die Eigenschaften und Anforderungen für Fliesen der 1. WAHL fest.

Die Norm EN 14411 wurde vom CEN (Europäische Komitee für Normung) veröffentlicht und enthält im Anhang ZA den harmonisierten Teil, der die Vorschriften für die Anbringung des CE-Zeichens gemäß der Verordnung des Europäischen Parlaments für die Vermarktung von Bauprodukten festlegt. Die CE-Kennzeichnung ist innerhalb der EU für die Inverkehrbringung der Fliesen zwingend erforderlich. Sie betrifft Fliesen aller Handelssortierungen und berücksichtigt die grundlegenden Sicherheitsanforderungen gemäß dem vom Hersteller deklarierten Anwendungsbereich.

Sämtliche Produkte von Emilceramica haben die anfänglichen und regelmäßigen Prüfungen gemäß der Norm UNI EN 14411 in der aktuell gültigen Fassung bestanden. Auf dieser Grundlage sind sie mit dem CE-Zeichen versehen und nach Anwendungsbereich klassifiziert.

Die Normen UNI EN ISO 10545/1-16 legen die Prüf- und Probeentnahmeverfahren für die Überprüfung der nach ISO 13006 und UNI EN 14411 vorgeschriebenen Eigenschaften fest.

Las normas ISO (International Organization for Standardization) se adoptan y están publicadas en todos los países adheridos (más de 150 estados del mundo entero). La ISO 13006 clasifica los azulejos de cerámica según el método de moldeo y la absorción de agua, y con respecto a cada grupo establece las características y los requisitos que definen a los azulejos de 1ª CALIDAD.

La norma EN 14411 ha sido publicada por el CEN (Comité Europeo de Normalización) y recoge en el apéndice ZA la parte «armonizada», que constituye el instrumento para la aplicación del marcado CE de conformidad con lo establecido en el vigente Reglamento del Parlamento europeo sobre la comercialización de los productos del ramo de la construcción. El marcado CE es obligatorio para la circulación de los azulejos dentro de la UE; se refiere a los azulejos de todas las clases comerciales y tiene en cuenta únicamente los requisitos fundamentales de "seguridad" con arreglo al uso al que estén destinados según lo declarado por el fabricante".

Todos los productos de Emilceramica cuentan con el marcado CE y son clasificados según el uso al que estén destinados tras superar las pruebas iniciales y periódicas establecidas por la norma UNI EN 14411 en su vigente versión.

Las normas UNI EN ISO 10545/1-16 proporcionan los métodos de prueba y de muestreo destinados a verificar las características establecidas por las normas ISO 13006 y UNI EN 14411.

Нормы ISO (Международная организация по стандартизации) приняты и опубликованы во всех странах-участницах (более 150 стран во всем мире). ISO 13006 классифицирует керамическую плитку на основании метода формовки и поглощения воды, и для каждой группы определяет характеристики и требования к плитке 1-ого СОРТА.

Стандарт EN 14411 был издан CEN (Европейским комитетом по нормализации) в октябре 2012 года и в приложении ZA приводит «гармонизированную» часть, в соответствии с которой на стройматериалы наносится маркировка CE, согласно действующему Регламенту Европарламента по торговле строительными материалами. Маркировка CE является обязательной для обращения плитки в пределах границ ЕС, распространяется на все продаваемые сорта и охватывает лишь только основные требования безопасности в соответствии со сферой назначения, заявленной производителем.

Вся продукция Emilceramica имеет маркировку CE и классифицируется по ее назначению, после прохождения начальных и периодических испытаний, предусмотренных нормой UNI EN 14411 в текущем ее варианте.

Нормы UNI EN ISO 10545/1-16 предоставляют методы испытания и отбора образцов для проверки характеристик, установленных нормой ISO 13006 и UNI EN 14411.

ISO 13006/UNI EN 14411 E UNI EN ISO 10545/1-16 CARATTERISTICHE TECNICHE GENERALI SECONDO LE NORME

General technical specifications in compliance with standards | Caracteristiques techniques generales selon les normes
Allgemeine technische eigenschaften nach den normen | Caracteristicas tecnicas generales conformes con las normas | Общие технические характеристики по нормам

Le piastrelle in ceramica, sono classificate in gruppi dalle norme citate in precedenza, in base al metodo di formatura ed al loro assorbimento d'acqua:
Ceramic tiles are classified in groups by the abovementioned standards according to the forming method and their water absorption:
Les normes susvisées classent en groupes les carreaux et dalles céramiques selon la méthode de fabrication et l'absorption d'eau :
Keramische Fliesen werden gemäß den oben genannten Normen auf der Grundlage des Formgebungsverfahrens und der Wasseraufnahme in Gruppen eingeteilt:
Los azulejos de cerámica están clasificados en grupos con arreglo a las citadas normas según el método de moldeo y la absorción de agua:
Керамическая плитка классифицируется указанными выше нормами по группам на основе метода формовки и поглощения воды:

GRUPPO A - GROUP A - GROUPE A- GRUPPE A - GRUPO A - ГРУППА "А"

- Piastrelle estruse, ossia foggiate allo stato plastico in un estrusore, quindi tagliate in dimensioni prefissate.
- Extruded tiles; i.e., plastic making in an extruder and then cut into set lengths.
- Carreaux étirés ou extrudés, c'est-à-dire dont la masse est façonnée à l'état plastique dans une étireuse, puis découpés en des carreaux de dimensions prédéterminées.
- Stranggepresste Fliesen. Herstellung durch Formung eines Stranges aus einer plastischen Masse mit Hilfe einer Strangpresse und anschließendes Abschneiden von Teilen in der vorgegebenen Größe.
- Azulejos extruidos —es decir, azulejos cuya masa es moldeada en estado plástico en un extrusor— y a continuación cortados en medidas establecidas previamente.
- Экструдированная плитка, то есть, сформованная в пластичном состоянии в экструдере, затем разрезанная на необходимые размеры.







GRUPPO B - GROUPE B - GRUPPE B - GRUPO B - ГРУППА "В"

- Piastrelle pressate a secco, ottenute partendo dalle materie prime in polvere o piccoli grani e foggiate in stampi a pressione elevata.
- Dry-pressed tiles, obtained from raw materials in the form of a powder or small grains and within high pressure moulds.
- Carreaux pressés à sec, dont la masse, à l'état de poudre ou de fins grains, est façonnée dans des moules sous pression élevée.
- Trockengepresste Fliesen. Herstellung aus Rohstoffen in Pulver- oder Granulatform, die unter hohem Druck in Formen gepresst werden.
- Azulejos prensados en seco que se fabrican a partir de materias primas en polvo o en gránulos y que son conformados en moldes a alta presión.
- Плитка сухого прессования, полученная исходя из порошкового сырья или мелких гранул и сформованная в пресс-формах при высоком давлении

Assorbimento d'acqua Water absorption Absorption d'eau Wasseraufnahme Поглощение воды	E ≤ 0,5%		0,5% < E ≤ 3%		3% < E ≤ 6%		6% < E ≤ 10%		E > 10%		
	Gruppo Group Groupe Gruppe Группа	A1a	Gruppo Group Groupe Gruppe Группа	A1b	Gruppo Group Groupe Gruppe Группа	A1a	Gruppo Group Groupe Gruppe Группа	A1b	Gruppo Group Groupe Gruppe Группа	A1a	A1b
A	Gruppo Group Groupe Gruppe Группа	A1a	Gruppo Group Groupe Gruppe Группа	A1b	Gruppo Group Groupe Gruppe Группа	A1a	Gruppo Group Groupe Gruppe Группа	A1b	Gruppo Group Groupe Gruppe Группа	A1a	A1b
B	Gruppo Group Groupe Gruppe Группа	B1a	Gruppo Group Groupe Gruppe Группа	B1b	Gruppo Group Groupe Gruppe Группа	B1a	Gruppo Group Groupe Gruppe Группа	B1b	Gruppo Group Groupe Gruppe Группа	B1a	B1b

NORME ISO E ASTM

ISO STANDARDS - NORMES ISO - ISO NORMEN - NORMAS ISO - НОРМЫ ISO
Dry-Pressed Ceramic Tiles - ISO 13006 Annex G - UNI EN 14411 Annex G - Bla GL
Dry-Pressed Ceramic Tiles - ISO 13006 Annex G - UNI EN 14411 Annex G - Bla UGL (**Be-Square**)

CARATTERISTICHE TECNICHE Technical Features - Caracteristiques Techniques - Technische Eigenschaften Technische Eigenschaften - Caracteristicas Tecnicas - Технические Характеристики	NORMA Standard - Norme Norm - Norma - Норма	VALORI Value - Valeur Vorgabe - Valor - Средние		
 ASSORBIMENTO D'ACQUA (VALORE MEDIO IN %) Water absorption (Average value expressed in %) Absorption d'eau (Valeur moyenne en %) Wasseraufnahme (Durchschnittswert in %) Absorción de agua (Valor medio en %) Поглощение воды	UNI EN ISO 10545/3	Conforme		
	ASTM C373	Compliant		
 RESISTENZA ALLA FLESSIONE Modulus of rupture - Resistance a la flexion - Biegefestigkeit Resistencia a la flexion - Прочность на изгиб	SPESSORE Thickness - Épaisseur Dicke - Espesor - Толщина	6,5 mm	10 mm	20 mm
	UNI EN ISO 10545/4	≥ 35 N/mm ²	≥ 45 N/mm ²	≥ 45 N/mm ²
FORZA DI ROTTURA Breaking strength - Résistance à la rupture - Bruchlast Resistencia a la rotura - Разрывное усилие	UNI EN ISO 10545/4	≥ 700 N	≥ 2000 N	≥ 12000 N
	ASTM C648	250 Lbs	400 Lbs	2500 Lbs
 RESISTENZA AL GELO Frost resistance - Résistance au gel - Frostbeständigkeit Resistencia a las heladas - Морозостойкость	UNI EN ISO 10545/12	Conforme		
	ASTM C1026	Unaffected		
 RESISTENZA CHIMICA AD ALTE E BASSE CONCENTRAZIONI DI ACIDI E BASI Chemical resistance to high and low acid and basic concentrations Résistance chimique aux hautes et basses concentrations d'acides et de bases Chemikalienfestigkeit bei hohen und niedrigen Konzentrationen von Säuren und Basen Resistencia química con concentraciones altas y bajas de ácidos y bases Химическая стойкость к высоким и низким концентрациям кислот и щелочей	UNI EN ISO 10545/13	A - LA - HA		
	ASTM C-650	Unaffected		
 RESISTENZA ALLE MACCHIE Stain resistance - Résistance aux taches - Fleckenbeständigkeit Resistencia a las manchas - Стойкость к образованию пятен	UNI EN ISO 10545/14	5		
 COEFFICIENTE DI ATTRITO Slip resistance Coefficient de glissement Rutschfestigkeit Barfußbereich Coeficiente de atrito medio Коэффициент трения	DIN 51130 DIN 51097 ANSI A 137.1 - 2012 DCOF (Section 9.6) B.C.R.A. AS 4586: 2013 Slip resistance classification of new pedestrian surface materials BS 7976-2: 2002 Pendulum testers ENV 12633-2006 Method of determination of unpolished and polished slip/skid resistance value	Vedi pagine collezione all'interno del catalogo See collection pages in catalogue Voir les pages relatives à la collection dans le catalogue Siehe Kollektion im Katalog Consulte las páginas de la colección en el catálogo Смотри коллекцию на отдельных страницах каталога		

SHADE VARIATION

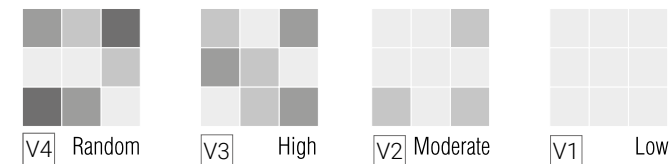

EMILCERAMICA

CERTIFICAZIONI

Certifications | Certifications | Zertifizierungen | Certificaciones | Сертификаты



Ceramics of Italy

Il marchio "Ceramics of Italy" è il marchio dell'industria ceramica italiana che identifica i prodotti di ceramica MADE IN ITALY ed il sistema di valori sociali, ecologici ed estetici che la contraddistingue.

L'Italia è un paese di antiche tradizioni ceramiche, che hanno saputo rivivere e rinnovarsi nella moderna produzione industriale. Il marchio "Ceramics of Italy" intende valorizzare questo importante patrimonio storico, culturale e produttivo.

The "Ceramics of Italy" mark is the mark of the Italian ceramics industry which identifies products that are MADE IN ITALY, with all the system of social, environmental and stylistic values this implies.

Italy is a country with a historic tradition in the manufacture of ceramics, which has been renewed and given new life in modern industrial production. The "Ceramics of Italy" mark is intended to promote and emphasise the value of this impressive historic, cultural and manufacturing heritage.

La marque "Ceramics of Italy" est la marque de l'industrie céramique italienne qui identifie les produits céramiques MADE IN ITALY, et le système de valeurs sociales, écologiques et esthétiques qui la distingue.

L'Italie est un pays de très anciennes traditions céramiques, qui ont su revivre et se renouveler dans la production industrielle moderne. La marque "Ceramics of Italy" entend valoriser cet important patrimoine historique, culturel et productif.

"Ceramics of Italy" ist das Markenzeichen der italienischen Keramikindustrie. Es identifiziert keramische Erzeugnisse MADE IN ITALY und ist ein Gütesiegel, das auf sozialen, ökologischen und ästhetischen Werten basiert. Italien ist ein Land mit einer alten Keramiktradition, die sich perfekt den Möglichkeiten der modernen Industrieproduktion und dem Trend der Zeit angepasst hat. Die Marke "Ceramics of Italy" soll dieses geschichtliche und kulturelle Erbe sowie die ausgesprochen hohe Produktionsqualität verkörpern.

"Ceramics of Italy" es la marca de la industria cerámica italiana que identifica los productos MADE IN ITALY, pero también es el sistema de valores sociales, ecológicos y estéticos que la caracteriza.

Italia es un país de antiguas tradiciones cerámicas, que han sabido revivir y renovarse en la moderna producción industrial. La marca "Ceramics of Italy" busca valorizar este importante patrimonio histórico, cultural y productivo.

Марка "Ceramics of Italy" - это марка итальянской керамической промышленности, идентифицирующая керамическую продукцию "MADE IN ITALY" и систему отличающих ее социальных, экологических и эстетических ценностей.

Италия - это страна с древними традициями в керамике, которые смогли пережить и возродиться в современном керамическом производстве. Марка "Ceramics of Italy" стремится к валоризации этого важного исторического, культурного и производственного наследия.



放射性水平A类

La certificazione CCC (China Compulsory Certificate), introdotta nel 2005, è obbligatoria per l'esportazione delle piastrelle in gres porcellanato in Cina ed è rilasciata esclusivamente da Enti di Certificazione accreditati dalle Autorità cinesi. Le caratteristiche oggetto della certificazione CCC riguardano in generale la sicurezza e la salute dell'utilizzatore finale.

CCC (China Compulsory Certificate) certification, introduced in 2005, is compulsory for the exportation of porcelain tiles to China and is only issued by Certification Bodies accredited by the Chinese authorities. In general, the characteristics covered by CCC certification relate to the health and safety of the end user.

La certification CCC (China Compulsory Certificate), introduite en 2005, est obligatoire pour l'exportation des carreaux de grès cérame en Chine et est délivrée exclusivement par des Organismes de certification accrédités par les autorités chinoises. Les caractéristiques, objet de la certification CCC, concernent en général la sécurité et la santé de l'utilisateur final.

Die 2005 eingeführte Zertifizierung CCC (China Compulsory Certificate) ist für den Export von Feinsteinzeugfliesen nach China erforderlich und wird ausschließlich von Zertifizierungsstellen ausgestellt, die von chinesischen Behörden akkreditiert sind. Die der CCC-Zertifizierung zugrunde liegenden Güteanforderungen beziehen sich im Allgemeinen auf die Sicherheit und Gesundheit des Verbrauchers.

La certificación CCC (China Compulsory Certificate), introducida en 2005, es obligatoria para la exportación de los azulejos de gres porcelánico a China y es otorgada exclusivamente por entidades de certificación acreditadas por las autoridades chinas. Las características objeto de la certificación CCC se refieren en general a la seguridad y la salud del usuario final.

Сертификация CCC (China Compulsory Certificate), введенная в 2005 году, необходима и обязательна для экспорта плитки из керамогранита в Китай и выдается лишь только сертифицирующими организациями, аккредитованными китайскими органами власти. Характеристики, являющиеся предметом сертификации CCC, касаются в основном безопасности и здоровья конечного пользователя.

EMILCERAMICA

CERTIFICAZIONI

Certifications | Certifications | Zertifizierungen | Certificaciones | Сертификаты



Per semplificare l'attuale scenario della certificazione nel settore delle costruzioni, massimizzare la leggibilità dei benchmark per la qualità, le prestazioni e l'affidabilità di prodotti, servizi e parti interessate, il Centro Scientifique et Technique du Bâtiment - CSTB - ha lanciato il nuovo marchio QB - Qualité du bâtiment (qualità delle costruzioni).

Questo nuovo marchio di certificazione sostituirà gradualmente i marchi CSTBat, CSTBat Service, Certifié CSTB e UPEC CSTB. Unificante e guidato da una potente comunicazione, QB contribuirà a rafforzare la reputazione del know-how, degli strumenti e delle soluzioni sviluppati dai players nel settore delle costruzioni, in Francia dal 2015 e a livello internazionale dal 2016. La certificazione dei prodotti "Piastrelle per pavimenti" si evolve dal marchio NF-UPEC verso il marchio QB-UPEC.

Da Maggio 2017 tutti i prodotti Emilceramica-Ergon-Viva, certificati UPEC sono stati contrassegnati con il nuovo marchio QB-UPEC, la cui classificazione attesta la conformità delle pavimentazioni ai requisiti tecnici stabiliti nei documenti di riferimento della certificazione. Il "classement QB-UPEC" indica che la durabilità di un prodotto è appropriata alla destinazione d'uso identificata per specifici locali.

To simplify the current situation concerning construction industry certification and maximise the legibility of benchmarks relating to the quality, performance and reliability of products, services and interested parties, the Centre Scientifique et Technique du Bâtiment - CSTB - has launched the new QB - Qualité pour le Bâtiment (building quality) mark.

This new certification mark will gradually replace the CSTBat, CSTBat Service, Certifié CSTB Certified and UPEC CSTB marks. A unifying force and supported by powerful communications, the QB mark will help to reinforce the standing of the know-how, tools and solutions developed by construction industry players, in France from 2015 and internationally from 2016. "Floor tile" product certification will evolve from the NF-UPEC mark to the QB-UPEC mark.

With effect from May 2017, all UPEC-certified Emilceramica-Ergon-Viva products carry the new QB-UPEC mark, certifying floor tiles' compliance with the technical requirements established in the certification standard documents. The "classement QB-UPEC" indicates that a product's durability is appropriate to its intended use, identified by specific rooms.

Afin de simplifier le paysage actuel de la certification dans le domaine de la construction, d'optimiser la lisibilité des repères de qualité, de performance et de fiabilité des produits, des services et des acteurs, le Centre Scientifique et Technique du Bâtiment - CSTB - a lancé la nouvelle marque QB - Qualité pour le Bâtiment.

Cette nouvelle marque de certification se substituera progressivement aux marques CSTBat, CSTBat Service, Certifié CSTB Certified et UPEC CSTB. Fédératrice, portée par une communication puissante, QB contribuera à renforcer le rayonnement du savoir-faire, des outils et des solutions développés par les acteurs de la construction, en France dès 2015, et à partir de 2016 à l'international. La certification des produits « Carreaux céramiques pour revêtements de sol » évolue de la marque NF associée à la marque UPEC, vers la marque QB associée au classement UPEC.

Depuis mai 2017, tous les produits Emilceramica-Ergon-Viva, certifiés UPEC, portent la nouvelle marque QB-UPEC, dont le classement atteste de la conformité des revêtements de sol à des spécifications techniques définies dans les référentiels de certification. Le « classement QB-UPEC » indique pour chaque produit que celui-ci est approprié à l'usage dans un local considéré, avec une durabilité suffisante et raisonnable.

Das Centre Scientifique et Technique du Bâtiment (CSTB, Wissenschaftliches und technisches Zentrum für Bauwesen) hat das neue Zertifizierungslabel QB - Qualité pour le Bâtiment (Bauqualität) geschaffen. Es dient der Vereinfachung des aktuellen Zertifizierungswesens in der Baubranche und soll die Benchmarks für Qualität, Performance und Zuverlässigkeit von Produkten, Dienstleistungen und Beteiligten deutlicher herausstellen.

Das neue Label wird schrittweise die Labels CSTBat, CSTBat Service, Certifié CSTB Certified und UPEC CSTB ablösen. Das vereinheitlichende QB-Logo gilt in Frankreich seit 2015 und weltweit seit 2016. Aufbauend auf eine starke Kommunikation soll es das Image von Knowhow, Tools und Lösungen der Baubranche stärken. An die Stelle des Zertifizierungslabels NF-UPEC für die Produkte „Bodenfliesen" wird daher das Logo QB-UPEC treten. Seit Mai 2017 sind alle UPEC-klassifizierten Produkte von Emilceramica-Ergon-Viva mit dem neuen Logo QB-UPEC gekennzeichnet, das ihre Übereinstimmung mit den technischen Zertifizierungsanforderungen bescheinigt. Die QB-UPEC-Klassifizierung gibt an, dass die Eigenschaften eines Produkts für die Zweckbestimmung der jeweiligen Räumlichkeit geeignet sind.

Para simplificar el escenario actual de la certificación en el sector de la construcción, maximizar la legibilidad de los puntos de referencia con respecto a la calidad, las prestaciones y la fiabilidad de los productos, servicios y partes involucradas, el Centre Scientifique et Technique du Bâtiment –CSTB– ha lanzado la nueva marca QB - Qualité pour le Bâtiment (calidad de los edificios).

Esta nueva marca de certificación substituirá gradualmente las marcas CSTBat, CSTBat Service, Certifié CSTB Certified y UPEC CSTB. Unificadora y guiada por una profusa comunicación, la marca QB contribuirá a reforzar la reputación del know-how, de las herramientas y de las soluciones desarrolladas por los actores en el sector de la construcción, en Francia desde 2015 y en el ámbito internacional desde 2016. La certificación de los productos "azulejos para pavimentos" evoluciona pasando de la marca NF-UPEC a la marca QB-UPEC.

Desde mayo de 2017 todos los productos Emilceramica-Ergon-Viva, certificados UPEC, se han señalado con la nueva marca QB-UPEC, cuya clasificación certifica la conformidad de las pavimentaciones con los requisitos técnicos establecidos en los documentos de referencia de la certificación. La clase QB-UPEC indica que la durabilidad de un producto resulta apropiada al uso que se le va a dar en locales específicos.

Для упрощения ситуации с сертификацией в сфере строительства, максимального понимания показателей качества, характеристик и надежности продукции, услуг и задействованных сторон, центр Centre Scientifique et Technique du Bâtiment - CSTB создал новый знак QB - Qualité pour le Bâtiment (качество строений).

Этот новый сертификационный знак постепенно заменит собой знаки CSTBat, CSTBat Service, Certifié CSTB Certified и UPEC CSTB. Объединяющий и поддерживаемый мощной коммуникационной кампанией, QB внесет свой вклад в укрепление репутации ноу-хау, инструментов и решений, разработанных операторами в сфере строительства: во Франции - с 2015 года, а на международном уровне - с 2016 года. Сертификация NF-UPEC продукции «Напольная плитка» будет заменена знаком QB-UPEC.

С мая 2017 года вся сертифицированная по UPEC продукция Emilceramica-Ergon-Viva была маркирована новым знаком QB-UPEC, классификация которого подтверждает соответствие полов изложенным в справочных документах техническим требованиям. Классификация QB-UPEC означает, что долговечность изделия соответствует назначению, указанному для определенных помещений.

EMILCERAMICA

CONSIGLI DI MANUTENZIONE

ISTRUZIONI PER LA PRIMA PULIZIA DOPO LA POSA

L'accuratezza e la tempestività della pulizia iniziale è di basilare importanza; è necessaria su tutte le tipologie di pavimentazione ceramica al fine di garantire un'agevole pulizia quotidiana. Nel caso in cui venisse trascurata e non effettuata potrebbero insorgere alonature che impedirebbero di mantenere pulito il pavimento nonostante una buona manutenzione quotidiana. È necessario lavare accuratamente il pavimento per rimuovere i residui cementizi e di stuccatura.

Per stucchi di tipo cementizio occorre attendere non più di 48 ore prima di effettuare la pulizia, per stucchi additivi con lattice o epossidici occorre effettuare molto rapidamente la pulizia in quanto l'indurimento dei componenti ne renderebbe molto difficoltosa la rimozione.

I prodotti indicati per questo tipo di pulizia devono essere di natura acida (vedi tabella esemplificativa).

Per realizzare la pulizia seguire i passaggi elencati sotto:

- Stesura del prodotto acido (Emilceramica consiglia DETERDEK® Fila) diluito in soluzione variabile da 10 a 20% sulla superficie.

- Attendere 7/10 minuti

- Effettuare la pulizia esercitando una decisa azione meccanica; utilizzare strumenti di pulizia manuale o adeguate macchine lavapavimenti (si consiglia l'utilizzo di macchine lava-pavimenti dotate di spazzole bianche in feltro; evitare l'utilizzo di spazzole nere a residuo carbonioso). L'operazione di lavaggio deve essere il più possibile omogenea.

- Neutralizzare la soluzione acida con abbondante risciacquo, possibilmente con acqua calda. Il risciacquo deve essere effettuato più volte fino alla completa rimozione di tutto il residuo acido.

Per agevolare l'esecuzione della pulizia acida iniziale si consiglia di utilizzare un apposito dispositivo aspira-liquidi allo scopo di evitare l'essiccazione della soluzione acqua-acido, la patina essiccata della soluzione renderebbe vana l'operazione di pulizia.

Per prodotti strutturati, con rilievi pronunciati o finiture antiscivolo il lavaggio acido deve essere effettuato con la massima rapidità dopo la posa. Prima del lavaggio acido, durante la posa, si consiglia di rimuovere gli eccessi di stuccatura con spugna e acqua.

Si consiglia di provare preventivamente il lavaggio su una piastrella non posata, in particolar modo in caso di prodotti lappati o levigati.

PROTEZIONE DEL PAVIMENTO FINO A TERMINE DEI LAVORI

Dopo la posa e la successiva pulizia, raccomandiamo di prestare particolare attenzione alla protezione del pavimento, per evitare di danneggiarlo durante i lavori di finitura del cantiere. Si consiglia di ricoprire l'intera superficie con cartoni di spessore adeguato.

ISTRUZIONI PER LA PULIZIA ORDINARIA

I prodotti Emilceramica sono di facile manutenzione, a conferma del nostro impegno verso l'ambiente. Le modalità e la frequenza di pulizia devono comunque essere adeguate alla destinazione d'uso.

Per una efficace manutenzione si consiglia:

1. Di non lasciare lo sporco troppo a lungo sul pavimento

2. Di lavare regolarmente il pavimento utilizzando detergenti neutri o sgrassatori diluiti in acqua calda seguendo le indicazioni delle confezioni (Emilceramica consiglia FILA CLEANER® Fila)

3. Risciacquare con acqua pulita

ISTRUZIONI PER LA PULIZIA STRAORDINARIA

La manutenzione straordinaria si rende necessaria nel caso in cui eventi accidentali causino macchie e/o sporco dovuto a particolari sostanze. In questi casi occorre intervenire con detergenti professionali a base alcalina specifici per il tipo di sporco da rimuovere (vedi tabella esemplificativa)

Per una efficace pulizia straordinaria si consiglia di:

1. Lavaggio con acqua per rimozione dello sporco superficiale

2. Stesura del prodotto alcalino (Emilceramica consiglia PS87 Fila) diluito in soluzione media del 3% sulla superficie. Per situazioni di difficile rimozione delle patine o di particolari agenti macchianti è possibile aumentare progressivamente la concentrazione del detergente.

3. Attesa di 7/10 minuti. Per agenti macchianti di difficile rimozione è possibile aumentare l'effetto abrasivo utilizzando un sapone secco in polvere da spargere sul detergente al termine del periodo di attesa.

MANUTENZIONE ED UTILIZZO DI SUPERFICI LAPPATE

Sabbia, pietrisco ed altri elementi di elevata durezza possono produrre graffiature su ogni tipo di pavimentazione, quali pietre naturale, legno, vinile e gres porcellanato.

Si consiglia pertanto di:

- rimuovere l'imballo contestualmente all'inizio della posa

- non impilare e/o movimentare il materiale privo di imballo

- non calpestare le superfici durante l'installazione

- pulire perfettamente il pavimento da residui di cantiere

- effettuare accurata copertura della superficie fino a fine lavori

EMILCERAMICA

ADVICE FOR MAINTENANCE

INSTRUCTIONS FOR INITIAL CLEANING AFTER INSTALLATION

Quick, thorough initial cleaning is of fundamental importance and is necessary on all types of ceramic tile to allow easy subsequent daily cleaning. In the event of the failure to carry out this procedure properly, smears may be left which make it impossible to keep the floor clean in spite of thorough routine cleaning.

The floor must be washed thoroughly to remove cement and grout residues.

For cement-based grouts, clean within no more than 48 hours. For grouts containing latex or epoxy resins, cleaning must be carried out very quickly, since the components are very difficult to remove once set.

The recommended products for this type of cleaning are acid-based (see table of examples).

To clean, proceed as follows:

- Apply the acid product (Emilceramica recommends Fila DETERDEK®) diluted in a 10-20% solution to the surface.

- Wait 7/10 minutes.

- Clean with a vigorous scrubbing action, with suitable equipment by hand, or appropriate floor cleaning appliances (floor cleaners fitted with white felt brushes are recommended; do not use black brushes which leave a carbon residue). Take care to clean the whole floor as evenly as possible.

- Neutralise the acid solution by washing with plenty of water, hot if possible. Keep rinsing until all acid residue has been removed.

To aid in the initial acid cleaning operation, use of a special vacuum drier is recommended to prevent the water-acid solution from drying; if the solution dries to form a coating over the surface, the cleaning procedure will have failed.

For structured products, with noticeable relief patterns or anti-slip surfaces, acid washing must be carried out as soon as possible after installation. Before washing with acid, excess grout should be removed with a sponge and water during the installation procedure itself.

The effect of the washing operation should be tested on a spare tile before proceeding, especially in the case of honed or polished products.

PROTECTING THE FLOOR DURING THE REMAINDER OF THE CONSTRUCTION WORK

After laying and cleaning, it is essential to take special care to protect the floor to prevent damage during finishing works on the site. The entire surface should be covered with cardboard of suitably thickness.

ROUTINE CLEANING INSTRUCTIONS

Emilceramica products are easy to care for, confirming our commitment to the environment. However, cleaning procedures and frequency will always depend on the context in which the tiles are used.

For effective care, we recommend the following:

1. Do not leave dirt on the floor for too long

2. Wash the floor regularly with neutral or degreasing detergents diluted in hot water, following the instructions on the pack (Emilceramica recommends Fila FILA CLEANER®)

3. Rinse with clean water.

EXTRAORDINARY CLEANING INSTRUCTIONS

Extraordinary cleaning procedures are needed if the floor becomes stained or dirty with specific substances due to accidents. In this case, professional, alkaline detergents, specifically developed for the type of dirt to be removed (see table of examples), are required.

For effective extraordinary cleaning, we recommend the following:

1. Wash with water to remove superficial dirt

2. Apply the alkaline product (Emilceramica recommends Fila PS87) diluted in a solution of about 3% to the surface. The detergent concentration can be gradually increased to deal with difficult cases where coatings have to be removed, or unusually tough stains.

3. Wait 7/10 minutes. For stubborn stains, the abrasive effect can be increased by using a dry powder soap, sprinkling it over the detergent at the end of the waiting time.

CARE AND USE OF SEMI-POLISHED SURFACES

Sand, gravel and other very hard substances may scratch any type of flooring, including natural stones, parquet, vinyl and porcelain stoneware.

You are therefore advised:

- to remove packaging only just before installation

- not to stack and/or handle material without its packaging

- not to tread on surfaces during installation

- to remove all worksite residues from the floor with great care

- to cover surfaces carefully until all work on site is complete

EMILCERAMICA

CONSEIL D’ ENTRETIEN

INSTRUCTIONS POUR LE PREMIER NETTOYAGE APRÈS LA POSE

Il est très important que le nettoyage initial soit effectué avec le plus grand soin et tout de suite après la pose, sur tous les types de carrelage céramique, afin de garantir un nettoyage quotidien facile. Si le nettoyage n’est pas bien fait, des auréoles pourraient se former et empêcher que le carrelage soit propre malgré un bon entretien quotidien. Laver soigneusement le carrelage pour enlever tous les résidus de ciment et de produit de jointoiment. Pour les ciments-joints, attendre moins de 48 heures avant de nettoyer, pour les adjuvants avec latex ou les joints époxy, effectuer le nettoyage très rapidement car si les composants durcissent leur enlèvement devient extrêmement difficile.

Les produits indiqués pour ce type de nettoyage doivent être de nature acide (voir tableau avec exemples).

Pour le nettoyage, procéder comme suit:

- Étaler sur la surface le produit acide (Emilceramica conseille DETERDEK® Fila) dilué dans une solution variable de 10 à 20%.

- Attendre 7/10 minutes

- Effectuer le nettoyage en exerçant une action mécanique ferme ; utiliser des instruments de nettoyage manuel ou des nettoyeurs appropriés (il est conseillé d’utiliser des nettoyeurs équipés de brosses blanches en feutre; éviter les brosses noires à résidu carboné). L’opération de lavage doit être le plus possible homogène.

- Neutraliser la solution acide avec un rinçage abondant, si possible à l’eau chaude. Le rinçage doit être fait plusieurs fois jusqu’à ce qu’il n’y ait plus du tout de résidu acide.

Pour faciliter le nettoyage acide initial, utiliser un dispositif approprié d’aspiration des liquides afin d’éviter le séchage de la solution eau-acide; la patine séchée de la solution rendrait inutile l’opération de nettoyage. Pour des produits structurés, avec des reliefs prononcés ou des finitions anti-dérapantes, le lavage acide doit être effectué le plus tôt possible après la pose. Avant le lavage acide, pendant la pose, enlever les surplus de produit de jointoiment avec une éponge et de l’eau. Il est conseillé de faire un essai avant le lavage sur un carreau non posé surtout dans le cas de produits rodés ou polis.

PROTECTION DU CARRELAGE JUSQU’À LA FIN DES TRAVAUX

Après la pose et le nettoyage, faire très attention à la protection du carrelage pour éviter de l’endommager pendant les travaux de finition du chantier. Il est conseillé de couvrir toute la surface avec des cartons d’une épaisseur appropriée.

INSTRUCTIONS POUR LE NETTOYAGE COURANT

Les produits Emilceramica sont d’un entretien facile ce qui confirme notre engagement pour la protection de l’environnement. Les modalités et la fréquence de nettoyage doivent être adaptées à la destination d’usage.

Pour un entretien efficace, il est conseillé:

1. De ne pas laisser le carrelage sale trop longtemps
2. De laver régulièrement le sol en utilisant des détergents neutres ou des produits de dégraissage dilués dans de l’eau chaude en suivant les indications des conditionnements (Emilceramica conseille FILA CLEANER® Fila)
3. De rincer à l’eau propre

INSTRUCTIONS POUR LE NETTOYAGE EXTRAORDINAIRE

L’entretien extraordinaire s’avère nécessaire si des actions accidentelles causent des taches et/ou de la saleté due à des substances particulières. Dans ces cas, intervenir avec des détergents professionnels à base alcaline, spécifiques pour le type de saleté à nettoyer (voir tableau avec exemples).

Pour un entretien extraordinaire efficace, il est conseillé:

1. De laver avec de l’eau pour enlever la saleté superficielle
2. D’étendre le produit alcalin sur la surface (Emilceramica conseille PS87 Fila) dilué en solution moyenne de 3%. Si la patine ou les agents tachants particuliers sont difficiles à nettoyer, augmenter progressivement la concentration du détergent.
3. Attendre 7/10 minutes. Pour des agents tachants difficiles à enlever, augmenter l’effet abrasif en utilisant un savon sec en poudre à répandre sur le détergent à la fin de la période d’attente.

ENTRETIEN ET UTILISATION DES SURFACES RODÉES

Le sable, la pierraille et les autres éléments présentant une dureté élevée risquent de rayer tous les revêtements de sol, comme les pierres naturelles, le bois, le vinyle et le grès cérame.

Il est recommandé de :

- retirer le matériel de son emballage uniquement au moment de la pose

- ne pas empiler ni manutentionner le matériel sans emballage

- ne pas marcher sur les surfaces pendant l’installation

- nettoyer parfaitement le revêtement de sol pour éliminer tous les résidus de chantier

- bien couvrir la surface jusqu’à la fin des travaux

EMILCERAMICA

PFLEGEHINWEISE

ANWEISUNGEN FÜR DIE ERSTREINIGUNG NACH DER VERLEGUNG

Eine gründliche und unverzügliche Erstreinigung ist von grundlegender Bedeutung. Sie ist für alle keramischen Bodenbeläge erforderlich, um eine einfache Unterhaltsreinigung zu gewährleisten.

Wird die Erstreinigung fahrlässig ausgeführt oder unterlassen, könnten Zementschleier entstehen, die trotz gründlicher Unterhaltsreinigung ein unsauberes Erscheinungsbild verursachen.

Die Bodenfläche ist gründlich mit Wasser zu reinigen, um Zement- und Mörtelrückstände zu entfernen.

Bei zementären Fugenmörteln dürfen bis zur Erstreinigung nicht mehr als 48 Stunden verstreichen, bei Fugenmörteln mit Latex- oder Epoxydharzvergütung ist die Reinigung sehr zügig auszuführen, weil die Komponenten andernfalls aushärten und die Entfernung ernsthaft erschweren.

Für die Erstreinigung sind saure Reiniger zu verwenden (siehe Übersichtstabelle).

Vorgehensweise für die Reinigung:

- Saures Reinigungsmittel (Emilceramica empfiehlt DETERDEK® Fila) in einer 10- bis 20-prozentigen Reinigungslösung auf die Oberfläche aufbringen.

- 7/10 Minuten abwarten.

- Mit energischen Wischbewegungen reinigen. Manuelle Reinigungsgeräte oder geeignete Reinigungsmaschinen verwenden (es werden Reinigungsmaschinen mit weißen Filzbürsten empfohlen, schwarze Bürsten mit Kohlerückständen sind nicht geeignet). Die Nassreinigung soll möglichst gleichmäßig erfolgen.

- Die saure Reinigungslösung durch eine reichliche Nachspülung mit Wasser, das möglichst warm sein sollte, neutralisieren. Es ist mehrmals mit Wasser nachzuspülen, bis alle Säurerückstände vollständig entfernt sind.

Für eine einfache Erstreinigung mit saurem Reiniger wird die Verwendung eines Flüssigkeitssaugers empfohlen, um die Antrocknung der Reinigungslösung zu vermeiden. Der angetrocknete Lösungsbelag würde die Reinigungswirkung aufheben.

Bei Erzeugnissen mit rutschhemmender, Struktur- oder Reliefoberfläche ist die Säurereinigung nach der Verlegung mit größter Zügigkeit auszuführen. Vor der Säurereinigung wird während der Verlegung empfohlen, überschüssigen Fugenmörtel mit Wasser und Schwamm zu entfernen.

Die Reinigung sollte zuvor probeweise auf einer unverlegten Fliese ausgeführt werden, das gilt insbesondere für geläppte und polierte Fliesen.

SCHUTZ DES BODENBELAGS BIS ZUR BEENDIGUNG DER ARBEITEN

Nach der Verlegung und der anschließenden Reinigung empfehlen wir, sorgfältig auf den Schutz des Bodens vor Beschädigungen während der Abschlussarbeiten zu achten. Es wird empfohlen, die gesamte Fläche mit Karton geeigneter Stärke abzudecken.

ANWEISUNGEN FÜR DIE UNTERHALTSREINIGUNG

Emilceramica achtet auf den Umweltschutz. Daher sind die Erzeugnisse des Keramikherstellers reinigungsfreundlich. Die Reinigungsverfahren und –häufigkeit müssen jedoch auf die Zweckbestimmung abgestimmt sein.

Empfehlungen für eine wirksame Unterhaltsreinigung:

1. Schmutz nicht zu lange auf dem Boden lassen.

2. Den Boden regelmäßig mit neutralen oder fettlösenden Reinigern in einer Reinigungslösung mit warmem Wasser gemäß den Verpackungsanweisungen reinigen (Emilceramica empfiehlt FILA CLEANER® Fila).

3. Mit sauberem Wasser nachspülen.

ANWEISUNGEN FÜR DIE SONDERREINIGUNG

Die Sonderreinigung ist erforderlich, wenn unerwünschte Ereignisse Flecken- und/oder Verunreinigungen infolge bestimmter Substanzen verursachen. In diesen Fällen sind professionelle alkalische Spezialreiniger in Abhängigkeit von dem zu entfernenden Schmutz zu verwenden (siehe Beispieltabelle).

Empfehlungen für eine wirksame Sonderreinigung:

1. Den Oberflächenschmutz durch Wischen mit Wasser entfernen.

2. Alkalisches Reinigungsmittel (Emilceramica empfiehlt PS87 Fila) in einer durchschnittlich 3-prozentigen Reinigungslösung auf die Oberfläche aufbringen. Bei hartnäckigen Streifen oder besonderen Fleckenbildnern kann die Konzentration des Reinigers schrittweise erhöht werden.

3. 7/10 Minuten abwarten. Bei hartnäckigen Fleckenbildnern kann die Abriebwirkung durch die Verwendung einer pulverförmigen Trockenseife erhöht werden, die nach der Wartezeit auf den Reiniger aufgestreut wird.

REINIGUNG, PFLEGE UND NUTZUNG GELÄPPTER OBERFLÄCHEN

Sand, Splitt und sonstige Elemente oder Teile mit erheblicher Härte können zu Kratzern auf jedem Bodenbelagstyp, z.B. aus Naturstein, Holz, Vinyl, Feinsteinzeug usw., führen.

Es empfiehlt sich deshalb, zum Schutz der Bodenbeläge folgende Maßnahmen zu ergreifen:

- die Verpackungen unmittelbar nach Beginn der Verlegearbeiten entfernen

- unverpacktes Material nicht stapeln und/oder handhaben bzw. bewegen

- während der Installation nicht auf die Oberflächen treten

- die Bodenbeläge einwandfrei reinigen und dabei sämtliche Baustellenreste vollständig entfernen

- die Oberfläche bis zum Abschluss der Arbeiten mit passenden Abdeckungen entsprechend schützen

EMILCERAMICA

CONSEJOS DE MANTENIMIENTO

INSTRUCCIONES PARA EFECTUAR LA PRIMERA LIMPIEZA TRAS LA COLOCACIÓN

La precisión y la rapidez de la limpieza inicial es de fundamental importancia; dicha limpieza es necesaria en todos los tipos de pavimentos cerámicos a fin de garantizar la facilidad de la limpieza diaria.Si, por no dársele la importancia necesaria, no se realiza esta limpieza, podrían crearse halos que impedirán mantener limpio el pavimento aunque se realice un mantenimiento diario correcto. Es necesario lavar a fondo el pavimento para retirar todos los restos de cemento y rejuntado. Para morteros cementosos, no se debe esperar más de 48 horas para realizar la limpieza; para morteros aditivados con látex o epoxídicos,

la limpieza se debe realizar muy rápidamente ya que, de lo contrario, el endurecimiento de sus componentes hará que sea muy difícil eliminar los restos. Los productos indicados para este tipo de limpieza deben ser de tipo ácido (consultar la tabla).

Para realizar la limpieza, seguir los pasos que aparecen a continuación.

- Aplicar el producto ácido (Emilceramica recomienda DETERDEK® Fila) diluido en solución variable entre 10 y 20 % sobre la superficie.

- Esperar entre 7 y 10 minutos.

- Realizar la limpieza ejerciendo una acción mecánica resuelta, utilizando instrumentos de limpieza manual o máquinas lava-pavimentos adecuadas (se aconseja usar máquinas lava-pavimentos provistas de escobillas blancas de fieltro; evítese el uso de escobillas negras que dejan residuos carbonosos). La operación de lavado debe ser lo más homogénea posible.

- Neutralizar la solución ácida enjuagando a fondo, posiblemente con agua caliente. El enjuague se debe efectuar varias veces, hasta que se elimine completamente los residuos ácidos. Para facilitar la limpieza ácida inicial, es aconsejable utilizar un dispositivo aspirador de líquidos a fin de evitar que se seque la solución de agua y ácido, ya que la pátina seca de la solución haría inútil la operación de limpieza. Para los productos estructurados, con relieves pronunciados o acabados antideslizantes, el lavado ácido se debe realizar lo más pronto posible tras su colocación. Antes del lavado ácido, durante la colocación, es aconsejable eliminar los restos de producto de rejuntado con una esponja mojada en agua. Es aconsejable hacer una prueba de lavado en una baldosa sobrante no colocada, especialmente cuando se trata de productos lapeados o pulidos.

PROTECCIÓN DEL PAVIMENTO HASTA LA CONCLUSIÓN DE LA OBRA

Tras la colocación y la limpieza, recomendamos tener especial cuidado para proteger el pavimento de forma que no se dañe durante los trabajos de finalización de la obra. Es recomendable cubrir toda la superficie con cartones que tengan un grosor adecuado.

INSTRUCCIONES PARA EFECTUAR LA LIMPIEZA ORDINARIA

Los productos de Emilceramica se caracterizan por su facilidad de mantenimiento, lo que confirma nuestro compromiso con el medio ambiente. No obstante, la modalidad y la frecuencia de limpieza se deben adaptar al uso previsto.

Para realizar un mantenimiento eficaz, es aconsejable:

1. No dejar el pavimento sucio durante demasiado tiempo.

2. Lavar con regularidad el pavimento utilizando detergentes neutros o desengrasantes diluidos en agua caliente, siguiendo las instrucciones del fabricante (Emilceramica recomienda FILA CLEANER® Fila).

3. Enjuagar con agua limpia.

INSTRUCCIONES PARA EFECTUAR LA LIMPIEZA EXTRAORDINARIA

Se debe realizar el mantenimiento extraordinario cuando por accidente se produzcan manchas y/o suciedad causadas por sustancias especiales. En estos casos, es necesario utilizar detergentes profesionales de base alcalina específicos para el tipo de suciedad que se debe eliminar (consultar la tabla). Para realizar una limpieza extraordinaria eficaz, es aconsejable:

1. Lavar el pavimento con agua para eliminar la suciedad superficial.

2. Aplicar el producto alcalino (Emilceramica recomienda PS87 Fila) diluido en solución media del 3% sobre la superficie. Para los casos en que sea difícil eliminar las pátinas o si las manchas han sido causadas por algún producto especial, se puede aumentar progresivamente la concentración del detergente.

3. Esperar entre 7 y 10 minutos. Para las manchas difíciles de eliminar, se puede aumentar el efecto abrasivo utilizando jabón en polvo seco que se esparce sobre el detergente tras finalizar el periodo de espera.

MANTENIMIENTO Y UTILIZACIÓN DE SUPERFICIES ESMERILADAS

La arena, la grava y demás elementos de elevada dureza pueden ocasionar arañazos en toda clase de pavimento, de piedra natural, de madera, vinilo o gres porcelánico.

Por ello se aconseja:

- no quitar el embalaje hasta que se vaya a proceder a la colocación

- no apilar ni desplazar el material si no está embalado

- no pisar las superficies durante la instalación

- limpiar perfectamente el pavimento de modo que no queden residuos de las obras

- mantener bien cubierta la superficie hasta la conclusión de los trabajos

EMILCERAMICA

ИНСТРУКЦИИ ПО ЭКСПЛУАТАЦИИ

ИНСТРУКЦИИ ПО ПЕРВОЙ ЧИСТКЕ ПОСЛЕ УКЛАДКИ

Тщательность и своевременность начальной чистки имеет чрезвычайную важность. Она необходима для всех типов керамического пола для облегчения ежедневной чистки.

В случае, если чисткой пренебрегают или ее не выполняют, могут образоваться разводы, которые не позволят содержать пол в чистоте, несмотря на хороший ежедневный уход.

Необходимо тщательно промыть пол, чтобы удалить остатки цемента и затирки.

Для затирок цементного типа следует подождать не более 48 часов перед выполнением чистки, для затирок с добавками латекса или эпоксидными чистку следует выполнять очень быстро, так как отвердевание компонентов может существенно затруднить удаление затирки. Продукты, рекомендованные для чистки данного типа, должны быть кислотными (см. пояснительную таблицу).

Для выполнения чистки выполняйте приведенные ниже действия:

- Нанесение кислотного продукта (Emilceramica рекомендует DETERDEK® Fila) в растворе от 10 до 20% на поверхности.

- Подождите 7/10 минут.

- Выполняйте чистку, оказывая решительное механическое воздействие. Используйте средства ручной чистки или же пригодные полотеры (рекомендуется использовать полотеры с белыми фетровыми щетками, не допускайте использование черных щеток, содержащих углерод). Чистка должна выполняться как можно более равномерно.

- Нейтрализуйте кислотный раствор обильной промывкой, желательнo горячей водой. Промывку следует выполнять несколько раз, вплоть до полного удаления остатков кислоты.

Для облегчения выполнения начальной кислотной чистки рекомендуется использовать специальное устройство для сбора жидкостей, чтобы не допустить высыхания водного раствора кислоты: высохшая патина раствора сделает операцию чистки бессмысленной.

Для структурированной продукции с выраженным рельефом или же несколькозой отделкой промывка кислотой должна выполняться как можно скорее после укладки. Перед промывкой кислотой, во время укладки, рекомендуется удалить излишки затирки губкой и водой.

Рекомендуется предварительно попробовать промывку на неужоженной плитке, в особенности, если это плитка с притертой или шлифованной поверхностью.

ЗАЩИТА ПОЛА ДО КОНЦА РАБОТ

После укладки и последующей очистки рекомендуем обратить особенное внимание на защиту пола, чтобы не допустить его повреждение во время отделочных работ при строительстве. Рекомендуется накрыть всю поверхность картоном необходимой толщины.

ИНСТРУКЦИИ ПО ОБЫЧНОЙ ЧИСТКЕ

Продукция Emilceramica проста в обслуживании, что подтверждает нашу заботу об окружающей среде. Способы и периодичность очистки должны в любом случае соответствовать назначению.

Для эффективного ухода рекомендуем:

1. Не оставлять грязь слишком надолго на полу.

2. Регулярно промывать пол, используя нейтральные или обезжиривающие средства, разбавленные в теплой воде, выполняя указания, приведенные на упаковках (Emilceramica рекомендует FILA CLEANER® Fila).

3. Промывать чистой водой.

ИНСТРУКЦИИ ПО ЭКСТРЕННОЙ ЧИСТКЕ

Экстренная чистка становится необходимой в тех случаях, когда случайные события приводят к образованию пятен и/или грязи, вызванных особенными веществами. В этих случаях следует использовать профессиональные моющие средства на щелочной основе, специально предназначенные для типа удаляемого загрязнения (см. пояснительную таблицу).

Для эффективной экстренной чистки рекомендуется:

1. Промывка водой для удаления грязи с поверхности.

2. Нанесение 3% раствора щелочного продукта (Emilceramica рекомендует PS87 Fila) на поверхность. В ситуациях с затрудненным удалением патин или особенных пятнообразующих агентов можно постепенно увеличивать концентрацию моющего средства.

3. Выдержка 7-10 минут. Для трудновыводимых пятнообразующих веществ можно повысить абразивный эффект, используя сухое порошковое моющее средство, наносимое на жидкое моющее средство по истечении времени выдержки.

УХОД И ИСПОЛЬЗОВАНИЕ ШЛИФОВАННЫХ ПОВЕРХНОСТЕЙ

Песок, мелкие камешки и другие материалы повышенной твердости могут образовывать царапины на полах любого типа, изготовленных из таких материалов, как природный камень, дерево, винил или керамогранит.

Поэтому, мы рекомендуем:

- распаковывать изделия, когда начинается их укладка

- не класть друг на друга и/или не перемещать упакованные материалы

- не ходить по поверхностям во время укладки

- тщательно очищать пол от строительных отходов

- тщательно накрыть поверхность до окончания работ

EMILCERAMICA

CONSIGLI DI MANUTENZIONE

Advice for Maintenance | Conseil d’ entretien | Pflegehinweise | Consejos de mantenimiento | Инструкции по эксплуатации

Tipo di sporco - Type of mark Type de salissure - Schmutzart Tipo de suciedad - Тип загрязнения	Detergente consigliato - Detergent recommended Detergent conseille - Empfohlenes Reinigungsmittel Detergente aconsejado - Рекомендуемое моющее средство		
	Solvente (acetone o acquaragia o trielina) Solvent Solvant Lösemittel Solvente Растворитель (ацетон или скипидар или разбавитель)	Detergente a base acida Acid based detergent Detergent a base acide Reinigungsmittel auf säurebasis Detergente de base ácida Моющее средство на кислотной основе	Detergente a base alcalina Alkaline based detergent Detergent a base alcaline Reinigungsmittel auf alkalibasis Detergente de base alcalina Моющее средство на щелочной основе
Birra, vino - Beer, wine - Bier,wein - Biere, vin - Cerveza,vino - Пиво, вино			PS-87 PRO
Caffè - Coffee - Cafe - Kaffee - Cafe - Кофе			PS-87 PRO
Catrame - Tar - Goudron - Teer - Alquitran - Гудрон	SOLV		
Caucciù - Rubber - Caoutchouc - Kautschuk - Caucho - Каучук	SOLV		
Cemento - Cement - Ciment - Zement - Cemento - Цемент		DETERDEK PRO	
Cera di candela - candle wax - Cire de bougie - Kerzenwachs - Cera de vela - Свечной воск	SOLV		
Coca cola - Coke - Coca-cola - Cоса-cola - Cоса-cola - Кока-кола			PS-87 PRO
Efflorescenze calcaree - Calcareous efflorescences - Efflorescenses calcaires Kalk ausbluehungen - Eflorescencias calcareas - Известковые проявления		DETERDEK PRO	
Gesso - Chalk - Platre - Gips - Yeso - Гипс		DETERDEK PRO	
Grassi animali - Animal fats - Graisses animales - Tierische fette Grasas animales - Животный жир			PS-87 PRO
Grassi vegetali - Vegetable fats - Grasas vegetales Pflanzliche fette graisses vegetales - Растительный жир			PS-87 PRO
Gelato - icecream - Glace - Eis - Helado - Мороженое			PS-87 PRO
Inchiestri - Inks - Encres - Tinte - Tintas - Чернила			PS-87 PRO - SR 95
Lampostil - Felt pens - Feutre - Filzstift - Rotuladores - Фломастер			PS-87 PRO
Ketchup - Кетчуп			PS-87 PRO
Maionese - Mayonnaise - Mayonnaise - Majonase - Майonesa - Майонез			PS-87 PRO
Marmellata - Jam - Confiture - Marmelade - Mermelada - Варенье			PS-87 PRO
Olii meccanici / siliconati - Mechanical / Silicone oils - Huiles mecaniques / siliconees Maschinen- Silikonöl - Aceites mecanicos/ con silicona - Механические/ Силиконовые масла	SOLV		PS-87 PRO
Olio di lino - Linseed oil - Huile de lin - Leinoel - Aceite de lino - Льняное масло	SOLV		
Pneumatico - Tyres - Pneumatique - Reifen - Neumatico - Следы шин			PS-87 PRO
Residui metallici - Metal residues - Residus de metaux Metallrueckstaende - Residuos metalicos - Следы металлов		DETERDEK PRO	
Resine o smalti - Resins or enamels - Resines ou emaux Harze oder lacke - Resinas o esmaltes - Смолы или эмали		NO PAINT STAR	
Rossetto - Lipstick - Rouge a levres - Lippenstift - Pintalabios - Помада			PS-87 PRO
Ruggine - Rust - Rouille - Rost - Herrumbre - Ржавчина		DETERDEK PRO	
Stucco - Plaster - Mastic - Fugenmasse - Estuco - Затирка		DETERDEK PRO	
Tempere murarie - Water based wall paint - Temperas murales Maueranstriche detrempes - Краски для стен		DETERDEK PRO	
Silicone - Silicone - Silicone - Silikon - Silicona - Силикон	SOLV		
Chewing-gum - Chewing-gum - Chewing-gum Kaugummi - Goma de mascar - Жевательная резинка			PS-87 PRO

ATTENZIONE! Usare molta prudenza utilizzando acidi o altri prodotti chimici, attenersi scrupolosamente alle istruzioni indicate dai produttori sulle confezioni. Si consiglia di cominciare sempre ad utilizzare i prodotti diluiti in acqua 1:5 e di aumentare gradualmente la concentrazione se non si ottiene l'eliminazione della macchia.

NOTE! Be very careful when using acids or other chemical products and strictly follow the manufacturer’s instructions on the product. It is always advisable to begin using the products diluted 1:5 in water and gradually increase the concentration if the mark or stain is not eliminated.

ATTENTION! Soyez très prudents lorsque vous employez des acides ou autres produits chimiques; suivez scrupuleusement les modes d'emploi des fabricants sur les emballages. Il est conseillé de commencer toujours à utiliser les produits dilués dans de l'eau (dilution 1:5) en augmentant graduellement la concentration si l'on n'obtient pas l'élimination de la tache.

ACHTUNG! Bei der Verwendung von Säuren oder anderen chemischen Produkten sollte man sich strikt an die Anweisungen des Herstellers auf den Verpackungen halten. Es wird empfohlen, die Produkte immer erst verdünnt (im Verhältnis 1:5 mit Wasser) zu verwenden und dann schrittweise die Konzentration zu erhöhen, wenn der Fleck sich nicht entfernen lässt.

ATENCION! Proceder con mucha prudencia al utilizar ácidos u otros productos químicos y respetar rigurosamente las instrucciones indicadas por los productores en los envases. Se aconseja comenzar siempre utilizando los productos diluidos en agua 1:5 y aumentar gradualmente la concentración si no se obtiene la eliminación de la mancha.

ВНИМАНИЕ! Будьте чрезвычайно осторожными, используя кислоты или другие химические продукты, тщательно придерживайтесь инструкций, указанных производителями на упаковках. Рекомендуется всегда использовать продукты, разбавленные в воде в пропорции 1:5, и постепенно повышать концентрацию, если пятно не выводится.

252 - EMILCERAMICA

EMILCERAMICA

POSA

Laying | Pose | Verlegung | Composicion | Укладка

GRADONE

I prodotti assemblati sono realizzati con collante tixotropico bi-componente ad alta reattività allo scopo di fornire al posatore un oggetto agevolmente installabile. Si ricorda ai signori posatori che la tenuta in opera nel tempo deve essere assicurata da un corretto riempimento del retro dello scalino o del bordo a elle.

La funzione di sgocciolatoio degli elementi a elle può essere realizzata con un riempimento parziale del retro che si limiti ai circa i 3/4 della lunghezza del frontalino.

STEP TILE

Pieces produced by combining more than one element are fixed together with a highly reactive dual compound thixotropic adhesive to provide the installer with an object which is easily laid. Installers are reminded that to ensure that tiles remain firmly in place over time, the back of the step or L-shaped edging tile must be filled in correctly.

To allow L-shaped edging tiles to provide drainage, only part of the back can be filled in, up to about 3/4 of the length of the front.

MARCHE

Les produits sont assemblés avec une colle bi-composant thixotrope très réactive pour simplifier la pose. Nous rappelons aux carreleurs de bien remplir la face arrière de la marche ou le bord en L pour garantir l’adhérence à long terme.

Pour réaliser le larmier des éléments en L, remplir en partie la face arrière, maximum 3/4 environ de la longueur du nez de marche.

STUFENABSCHLUSSFLIESE

Die mehrteiligen Produkte sind mit einem thixotropen Zweikomponenten-Kleber mit hoher Reaktionsfähigkeit für eine einfache Verlegung ausgeführt. Für eine hohe Langzeitqualität des Gewerkes ist eine ordnungsgemäße Ausfüllung der Rückseite des Treppenauftritts oder der L-Kante erforderlich.

Die Abflussfunktion der L-Elemente kann mit einer teilweisen Ausfüllung der Rückseite auf ungefähr 3/4 der Frontteillänge erzielt werden.

ESCALÓN

Los productos ensamblados se fabrican con adhesivo tixotrópico bicomponente de alta reactividad con el fin de proporcionarle al solador un objeto de fácil instalación. Se recuerda a los soladores que la durabilidad de la obra se asegura rellenando correctamente la parte de atrás del escalón o del borde en forma de "L".

La función de vierteaguas de los elementos en forma de "L" se puede conseguir rellenando el reverso sólo hasta aproximadamente tres cuartos de la longitud de la contrahuella para de este modo formar un goterón.

СТУПЕНЬ

Сборные изделия склеиваются с применением очень реактивного тиксотропного двухкомпонентного состава, что позволяет предоставлять плиточнику легко монтируемое изделие. Напоминаем плиточникам, что для обеспечения долговечности монтажа необходимо правильно заполнять тыльную сторону ступени или Г-образного края.

Чтобы обеспечить стекание воды с Г-образных элементов, можно предусмотреть частичное заполнение длины загиба с тыльной стороны, приблизительно на 3/4.

EMILCERAMICA

DESTINAZIONI D’ USO

Intended uses | Domaines d’application | Zweckbestimmung | Usos previstos | Назначение

Destinatões de uso

I prodotti Emilceramica sono realizzati con le più moderne tecnologie disponibili nel settore ceramico allo scopo di ottenere elevate prestazioni qualitative. Con una pressione applicata di oltre 400 kg/cm², il grés porcellanato di Emilceramica ottiene elevate caratteristiche tecniche che permettono l'utilizzo sia in ambito commerciale, ad alto traffico e carrabilità, sia in ambito residenziale, date le particolari doti estetiche. Il rigido controllo del ciclo di cottura e l'accurata selezione delle materie prime utilizzate a protezione della superficie, determinano una altissima resistenza all'usura e di conseguenza una totale versatilità di utilizzo. Il rispetto delle prescrizioni suggerite consentirà di preservare inalterate nel tempo le caratteristiche tecniche ed estetiche del grés porcellanato acquistato.

Destinaciones de uso

Emilceramica products are manufactured using technologies at the ceramics industry state of the art, in order to deliver impressive quality performance. Subjected to a pressure of more than 400 kg/cm², Emilceramica porcelain stoneware has excellent technical characteristics that make it suitable for use both in commercial locations, with heavy use or vehicle traffic, and in the home, thanks to its exquisite appearance. The strict control of the firing cycle and careful selection of the raw materials used to protect the surface provide outstanding resistance to wear and thus total versatility in use. Compliance with the manufacturer’s recommendations will ensure that the porcelain stoneware purchased maintains all its technical and appearance features over time.

Destinações de uso

Les produits Emilceramica sont réalisés en faisant appel aux technologies les plus modernes disponibles dans le secteur céramique afin d'obtenir les meilleures prestations en matière de qualité. Avec une pression appliquée de plus de 400 kg/cm², le grès cérame d’Emilceramica possède d’excellentes caractéristiques techniques qui permettent de l'utiliser dans les commerces fortement fréquentés et soumis à de nombreux passages de clientèle, ainsi que dans le secteur résidentiel étant donné ses extraordinaires qualités esthétiques. Le contrôle rigoureux du cycle de cuisson et la sélection soignée des matières premières utilisées pour la protection des surfaces entraînent une très forte résistance à l'usure et, par conséquent, une totale polyvalence d'utilisation des produits Emilceramica. Le respect des instructions données permettra de conserver durablement les caractéristiques techniques et esthétiques des produits en grés cérame achetés.

Destinações de uso





Die Emilceramica Produkte werden mit den modernsten in der Keramikbranche verfügbaren Technologien hergestellt, um qualitativ hochwertige Performances zu gewährleisten. Der hierbei angewandte Druck von über 400 kg/cm² verleiht dem Emilceramica Feinsteinzeug ausgezeichnete technische Eigenschaften, die eine Verlegung in Gewebereichen mit intensiver Beanspruchung und hohem Fahrzeug- und Personenaufkommen erlauben. Dank der besonderen ästhetischen Vorzüge bietet sich auch die Verlegung in Wohnbereichen an. Die strenge Kontrolle des Brennzklus und die sorgfältige Auswahl der zum Schutz der Oberfläche verwendeten Rohstoffe garantieren eine sehr hohe Verschleißfestigkeit, wodurch das Produkt praktisch überall eingesetzt werden kann. Die Einhaltung der empfohlenen Vorschriften gewährleistet, dass die technischen und ästhetischen Eigenschaften des erworbenen Feinsteinzeugs langfristig unverändert bleiben.

Destinações de uso

Los productos de Emilceramica se realizan con las tecnologías más modernas que ofrece la industria cerámica, a fin de obtener un alto rendimiento desde el punto de vista de la calidad. Con las excelentes características técnicas que le confiere la presión de prensado de más de 400 kg/cm², el gres porcelánico de Emilceramica puede utilizarse en ámbito comercial (zonas con tránsito peatonal y tráfico rodado intensos), así como en usos residenciales gracias a sus especiales cualidades estéticas. El severo control del ciclo de cocción y la selección atenta de las materias primas utilizadas para proteger la superficie se traducen en una altísima resistencia al desgaste y, por consiguiente, una versatilidad de uso total. El cumplimiento de las recomendaciones indicadas permitirá mantener inalteradas las características técnicas y estéticas del gres porcelánico comprado.

Destinações de uso

Продукция Emilceramica производится с использованием самых современных технологий, существующих в керамической промышленности, для получения высоких характеристик качества. При прикладываемом давлении свыше 400 кг/см² керамогранит Emilceramica приобретает высокие технические характеристики, позволяющие использовать его как в коммерческой среде с интенсивным трафиком и движением транспортных средств, так и в жилом секторе, ввиду его высоких эстетических свойств. Жесткий контроль цикла обжига и тщательный отбор использованного сырья, защищающего поверхности, обеспечивает высочайшую износостойкость, следовательно, полную универсальность использования. Соблюдение рекомендаций позволит сохранить неизменными во времени технические и эстетические характеристики приобретенного вами керамогранита.

	Alto traffico urbano ed industriale (es. magazzini, depositi, fabbriche).	Heavy urban and industrial traffic (e.g. warehouses, stores, factories).	Passage intense urbain et industriel (ex. entrepôts, dépôts, usines).	Starker städtischer und gewerblicher Verkehr (z.B. Lager, Depots, Fabriken).	Alto tráfico urbano e industrial (por ej. almacenes, depósitos, fábricas).	Интенсивное движение городских и промышленных транспортных средств (напр., склады, хранилища, предприятия).
	Alto traffico pedonale (es. stazioni ferroviarie, aereoporti, centri commerciali).	Heavy pedestrian traffic (e.g. railway stations, airports, retail malls).	Piétinement intense (ex. gares, aéroports, centres commerciaux).	Starker Fußgängerverkehr (z.B. Bahnhöfe, Flughäfen, Einkaufszentren).	Alto tráfico peatonal (por ej. estaciones de tren, aeropuertos, centros comerciales).	Интенсивное пешеходное движение (напр., железнодорожные вокзалы, аэропорты).
	Medio traffico per ambienti pubblici (es. ristoranti, uffici, negozi).	Medium traffic levels for public premises (e.g. restaurants, offices, shops).	Passage modéré pour lieux publics (ex. restaurants, bureaux, magasins).	Mittelstarker Verkehr in öffentlichen Bereichen (z.B. Gaststätten, Büros, Geschäfte).	Tráfico medio en espacios públicos (por ej. restaurantes, oficinas, tiendas).	Среднее движение в общественных местах (напр., рестораны
	Ambienti residenziali (es. zona giorno, zona notte, camere di alberghi, bagni).	Residential rooms (e.g. living-rooms, bedrooms, hotel rooms, bathrooms).	Espaces résidentiels (ex. cuisine, salle à manger, chambres à coucher, salles de bains).	Privatbereiche (z.B. Wohnbereich, Schlafbereich, Hotelzimmer, Badbereich)	Ámbitos residenciales (por ej. zona de día, zona de noche, habitaciones de hotel, baños)	Жилые объекты (напр., гостиные, спальни, гостиничные номера, ванные)

Destinatões de uso

EMILCERAMICA

IL TAGLIO DELLE PIASTRELLE IN GRES PORCELLANATO

Cutting porcelain stoneware tiles | La découpe des carreaux en gres cerame | Schneiden von Feinsteinzeugfliesen

Corte de los azulejos de gres porcelánico | Резка керамогранитной плитки

Destinatões de uso

La gamma Emilceramica in gres porcellanato viene realizzata con le più moderne tecnologie disponibili sul mercato al fine di ottenere valori assai ridotti di assorbimento d’acqua; secondo gli standard UNI EN ISO 10545-3/ ASTM C373 per essere definito “gres porcellanato” il prodotto ceramico deve riportare valori di assorbimento ≤ 0.5% (Gruppo “Bla” secondo la norma ISO 13006, Classe “P1” secondo la ANSI A 137.1), sebbene i prodotti Emilceramica siano normalmen- te realizzati a valori inferiori. Tale caratteristica consente di ottenere pavimenti dalle elevate prestazioni di tenacità e resistenza alla flessione e quindi idonei ad un utilizzo sottoposto ad elevata sollecitazione meccanica e traffico sostenuto. Il basso assorbimento è altresì garanzia di resistenza al gelo, così come definito dallo standard UNI EN ISO 10545-12 o dalla normativa americana ASTM C1026. La tenacità superficiale comporta in taluni casi una certa resistenza della superficie ceramica in fase di taglio. L’osservanza di alcune prescrizioni basilari consente di ridurre gli scarti durante la posa e accelerare le operazioni di installazione delle piastrelle.

Destinatões de uso

The porcelain stoneware Emilceramica range is manufactured using the very latest technologies available on the market, to achieve very low water absorpion values; under the UNI EN ISO 10545-3/ ASTM C373 standards, to be defined as “porcelain stoneware” ceramic tiles must have absorption ≤ 0.5% (Group “Bla” under the ISO 13006 standard, Class “P1” under ANSI A 137.1), although Emilceramica products are generally manufactured to deliver values below this. These characteristics give the floor tiles exceptional toughness and bending strength values, making them suitable for uses subjected to high mechanical stresses and heavy traffic. The low absorption also ensures resistance to frost, as defined by the UNI EN ISO 10545-12 and ASTM C1026 standards. In some cases, the toughness of the surface may render the ceramic surface rather hard to cut. Compliance with a few simple rules will help to reduce waste during laying and speed up tile installation operations.

Destinatões de uso

La gamme Emilceramica en grès cérame a été réalisée en faisant appel aux technologies les plus modernes disponibles sur le marché afin d'obtenir des valeurs d'absorption d'eau très faibles conformément aux normes UNI EN ISO 10545-3 et ASTM C373. Pour obtenir l'appellation de grès cérame, les produits en céram- ique doivent posséder des valeurs d'absorption d'eau ≤ 0.5% (Groupe “Bla” selon la norme ISO 13006, Classe “P1” selon la norme ANSI A 137.1). Les produits Emilceramica sont normalement fabriqués avec des taux inférieurs. Cette caractéristique permet d'obtenir des sols offrant d'excellentes prestations, en termes de solidité et de résistance à la flexion, en mesure d’être utilisés pour des applications prévoyant de fortes contraintes mécaniques et des passages élevés de personnes. Le faible taux d’absorption de l’eau constitue également un gage de résistance au gel définie par les normes UNI EN ISO 10545-12 et ASTM C1026. La solidité de la surface des carreaux entraîne parfois une certaine résistance de la surface céramique lors de la phase de coupe. Le respect des instructions de base reportées ci-dessous permet de réduire les rebuts durant la pose et d’accélérer les opérations d’installation des carreaux.

Destinatões de uso

Die Feinsteinzeugserie Emilceramica wird unter Anwendung der modernsten am Markt verfügbaren Technologien hergestellt, um sehr niedrige Wasseraufnah- mewerte zu gewährleisten. Nach den Vorgaben der Normen UNI EN ISO 10545-3 und ASTM C373 muss ein Keramikprodukt Wasseraufnahmewerte ≤ 0,5% (Gruppe „Bla“ gemäß Norm ISO 13006, Klasse „P1“ gemäß Norm ANSI A 137.1) aufweisen, um als „Feinsteinzeug“ definiert werden zu können. Dies trifft in jeder Hinsicht für die Emilceramica Produkte zu, die sich in der Regel durch noch niedrigere Werte auszeichnen. Dadurch erhält man Bodenbeläge mit sehr hohen Bru- ch- und Biegefestigkeitswerten, die sich hervorragend für Bereiche mit intensiver mechanischer Beanspruchung und hohem Fahrzeug- und Personenaufkom- men eignen. Der niedrige Wasseraufnah mewert ist ferner die Garantie für eine entsprechende Frostbeständigkeit, wie sie in der Norm UNI EN ISO 10545-12 oder ASTM C1026 festgelegt ist. Die Festigkeit der Keramikoberfläche leistet in bestimmten Fällen einen gewissen Widerstand, muss die Fliese geschnitten werden. Durch die Einhaltung einiger grundlegender Vorschriften vermeidet man unnötigen Abfall während der Arbeit und beschleunigt somit die Verlegung der Fliesen.

Destinatões de uso

La gama Emilceramica de gres porcelánico se realiza sirviéndose de las tecnologías más modernas que ofrece el mercado, a fin de obtener unos valores muy reducidos de absorción de agua. Según las normas UNI EN ISO 10545-3 y ASTM C373, para poder llamarlo «gres porcelánico», el producto cerámico debe tener un valor de absorción ≤ 0,5% (Grupo Bla según la norma ISO 13006, clase P1 según la norma ANSI A 137.1). Por lo general, los productos Emilceramica se realizan con valores inferiores, lo que permite obtener pavimentos con un alto valor de tenacidad y resistencia a la flexión, perfectos para los usos sujetos a grandes tensiones mecánicas y tráfico intenso. Además, su bajo valor de absorción garantiza la resistencia a las heladas, tal como establece la norma UNI EN ISO 10545-12 o la ASTM C1026. En algunos casos, la tenacidad superficial implica que la superficie cerámica oponga una cierta resistencia durante la fase de corte. El cumplimiento de algunas recomendaciones básicas permitirá reducir los desechos durante la colocación y agilizar las operaciones de instalación de los azulejos.

Destinatões de uso

Гамма Emilceramica из керамогранита производится с использованием самых современных технологий из имеющихся на рынке с целью получения очень низких значений впитывания воды. В соответствии со стандартом UNI EN ISO 10545-3/ ASTM C373 керамогранитом называется керамическая продукция со значениями впитывания ≤ 0.5% (Группа “Bla” по норме ISO 13006, Класс “P1” в соответствии с ANSI A 137.1), несмотря на то, что продукция Emilceramica, как правило, выпускается с более низкими значениями. Эта характеристика позволяет получать полы с высокими характеристиками стойкости и прочности на изгиб, следовательно, пригодными к использования с высокими механическими нагрузками и интенсивным трафиком. Кроме того, низкое впитывание воды - это гарантия морозостойкости, как определяется стандартом UNI EN ISO 10545-12 или ASTM C1026. Прочность поверхности приводит в некоторых случаях к определенному сопротивлению керамической поверхности во время резки. Соблюдение некоторых основных рекомендаций позволяет снизить количество отходов во время укладки и ускорить работы по укладке плитки.

IL TAGLIO DELLE PIASTRELLE IN GRES PORCELLANATO - PRESCRIZIONI BASILARI

Cutting porcelain stoneware tiles - Fundamental rules | La découpe des carreaux en gres cerame - Instructions de base | Schneiden von Feinsteinzeugfliesen - Grundlegende Vorschriften | Corte de los azulejos de gres porcelánico - Recomendaciones básicas | Резка керамогранитной плитки - Основные рекомендации



Stato della taglia-piastrelle Verificare che la meccanica sia in buono stato. Accertarsi che la lama di incisione non sia eccessivamente consumata e abbia perso la sua taglienza. Controllare che non vi siano vibrazioni anomale tra le componenti meccaniche, gli scorrimenti e i perni di fissaggio. È consigliabile lubrificare costantemente la lama.

State of the tile-cutter Check that the tool to be used is in good working order. Make sure that the blade is not too worn or blunt. Check the mechanical components, moving parts and fixing pins for excessive vibration. The blade should be constantly lubricated.

Etat du decoupeur de carreaux Vérifier que l'appareil soit en parfait état. Vérifier que la lame de coupe ne soit pas excessivement usée et n'ait pas perdu son pouvoir de coupe. Vérifier qu'il n'y ait aucune vibration anormale entre les composants mécaniques, les guides et les goupilles de fixation de l'appareil. Il est conseillé de lubrifier constamment la lame.

Zustand des Fliesenschneidgeräts Prüfen, ob keine mechanische Mängel vorliegen. Sicherstellen, dass das Schneidrad nicht zu sehr abgenutzt ist und seine Schneidleistung nicht eingebüßt hat. Prüfen, ob keine ungewöhnlichen Vibrationen zwischen den mechanischen Komponenten, den Gleitteilen und den Befestigungsbolzen zu verzeichnen sind. Es empfiehlt sich, das Schneidrad regelmäßig zu schmieren.

Estado del cortador Comprobar que los componentes mecánicos estén en buen estado. Asegurarse de que la rulina no esté demasiado consumida y que no haya perdido su capacidad de rayado. Comprobar que no se produzcan vibraciones anómalas en los componentes mecánicos, las guías de deslizamiento y los pernos de fijación. Es aconsejable lubricar continuamente la rulina.

Состояние плиткореза Проверьте хорошее состояние механической части плиткореза. Убедитесь, что режущий ролик не износился и не затупился. Проверьте отсутствие аномальной вибрации в механических компонентах, в узлах скольжения и крепежных пальцах. Рекомендуется постоянно смазывать полотно.



Manualità Accertarsi di esercitare una pressione costante dell'incisore sull'intera superficie del pezzo. Per il taglio di prodotti particolarmente tenaci è opportuno realizzare una doppia incisione (doppio passaggio). Per agevolare l'incisione occorre regolare l'altezza del fermo meccanico secondo lo spessore del materiale.

Cutting Skill Ensure that the scoring unit applies a constant pressure to the entire surface of the piece. When cutting particularly tough products, two scoring passes should be made. For easier scoring, adjust the height of the mechanical stop as appropriate to the thickness of the material.

Technique de coupe Faire en sorte d'exercer une pression constante sur le découpeur de carreaux et sur toute la surface des carreaux. Pour la coupe de produits particulièrement résistants, il convient de réaliser une double coupe (double passage). Pour faciliter la coupe, il convient de régler la hauteur de la butée mécanique selon l'épaisseur des carreaux à couper.

Handhabung Sicherstellen, dass das Schneidrad mit einem konstanten Druck auf der gesamten Länge der Fliesenoberfläche geführt wird. Zum Schneiden besonders hartnäckiger Fliesen ist ein Doppelschnitt (zweimaliges Einschneiden) auf diesen vorzunehmen. Um den Schnitt einwandfrei ausführen zu können, ist die Höhe des mechanischen Anschlags je nach Stärke des Materials entsprechend einzustellen.

Ejecución Asegurarse de ejercer una presión uniforme con el rodel a lo largo de toda la superficie de la pieza. Para cortar productos especialmente duros, se puede realizar un rayado doble (dos pasadas). Para facilitar el rayado, hay que ajustar la altura del tope mecánico según el grosor del material.

Мастерство Убедитесь, что вы оказываете постоянный нажим на режущий ролик на всей поверхности изделия. Для резки изделий, обладающих особенной твердостью, рекомендуется выполнять двойной надрез (двойной проход). Для облегчения выполнения надреза следует отрегулировать высоту механического стопора по толщине материала.



Utensili specifici Nel caso in cui si decida di effettuare un taglio con flessibile occorre accertarsi che i dischi siano adatti al taglio del gres porcellanato e che la velocità sia ridotta; è opportuno l'utilizzo di flessibili a velocità variabile.

Specific tools If an angle-grinder is used for cutting, make sure that the discs are suitable for cutting porcelain stoneware and that the tool's rotation speed is low; variable speed tools are recommended.

Outils spécifiques Au cas où l'on choisisse de couper les carreaux avec un découpeur-perceur, il convient de vérifier que les disques soient adaptés à la coupe du grès cérame et que leur vitesse soit réduite. Il est conseillé d'utiliser des découpeurs-perceurs à vitesse variable.

Spezialwerkzeuge Sollen Schnitte mit einem Trennschneider ausgeführt werden, ist sicherzustellen, dass die Scheiben für den Schnitt von Feinsteinzeug ausgelegt sind und hierbei die Drehzahl niedrig gehalten wird; es empfiehlt sich die Verwendung von Trennschneidern mit variabler Drehzahl.

Herramientas específicas Si se opta por realizar el corte con una amoladora, habrá que comprobar que los discos sean adecuados para cortar gres porcelánico y que se use una velocidad reducida; es oportuno usar amoladoras de velocidad variable.

Специальный инструмент В случае, если вы решите выполнять резку болгаркой, то следует убедиться, что диски пригодны для резки керамогранита, и что скорость резки невысокая. Рекомендуется использовать болгарку с регулировкой скорости.

IL TAGLIO DELLE PIASTRELLE IN GRES PORCELLANATO - PRESCRIZIONI BASILARI

Cutting porcelain stoneware tiles - Fundamental rules | La découpe des carreaux en gres cerame - Instructions de base | Schneiden von Feinsteinzeugfliesen - Grundlegende Vorschriften | Corte de los azulejos de gres porcelánico - Recomendaciones básicas | Резка керамогранитной плитки - Основные рекомендации



Taglio ad acqua Per una migliore gestione del taglio su gres porcellanato è consigliato l'utilizzo di taglia-piastrelle ad acqua. La macchina ad acqua riduce gli scarti dovuti alla durezza superficiale della piastrella e realizza una migliore qualità del taglio.

Waterjet cutting For the best results when cutting porcelain stoneware, a waterjet tile cutter should be used. With waterjet tools, there are fewer rejects due to the tiles hard surface and the quality of cut is better.

Découpe par jet d'eau Afin d'obtenir une meilleure coupe des carreaux en grès cérame, il est conseillé d'utiliser des découpeurs-perceurs de carreaux à eau. En effet, ces appareils réduisent les rebuts dus à la dureté de la surface des carreaux et permettent d'obtenir une coupe de meilleure qualité.

Wasserstrahlschneiden Beste Schmittergebnisse bei Feinsteinzeug erhält man mit einem Nass-Fliesenschneidgerät. Durch ein mit Wasser arbeitendes Schneidgerät reduziert man das Risiko zahlreicher auf die harte Oberfläche zurückzuführender Fliesenabfälle und gewährleistet eine bessere Schnittqualität.

Corte mediante chorro de agua a presión Para controlar mejor el corte del gres porcelánico, es aconsejable utilizar un cortador refrigerado por agua. El cortador de agua reduce los desechos debidos a la dureza superficial del azulejo y realiza un corte de mejor calidad.

Гидрорезка Для получения наилучших результатов резки керамогранита рекомендуется использовать водяные плиткорезы. Водяные плиткорезы снижают количество отходов, вызванное твердостью поверхности плитки и позволяют получить наилучшее качество резки.



La foratura La foratura per il passaggio di cavi si realizza utilizzando apposite frese diamantate su trapani a velocità variabile; è sempre consigliabile una velocità molto ridotta dell'utensile osservando i necessari tempi di lavoro. Si raccomanda di non continuare ad utilizzare la fresa una volta esaurita la taglienza. Per ottenere un inserto quadrato per l'installazione di scatole elettriche occorre realizzare 4 fori sugli spigoli del perimetro utilizzando una fresa diamantata di piccolo diametro (6-8 mm); in tal modo vengono alleggerite le tensioni interne della piastrella sulla quale, in seguito, si possono effettuare i tagli di congiunzione con un disco diamantato.

Boring Holes to allow the passage of electrical wiring are made using special diamond tools mounted on variable speed drills. The tool rotation speed should always be very low; do not rush this operation. Never keep on using a blunt tool. To make a square opening to fit over an electric wiring box, first drill 4 holes in the corners of the opening with a small-diameter diamond tool (6-8 mm) to reduce the stresses within the tile, after which the cuts between these holes can be made using a diamond disc.

Le perçage Le trou pour le passage des câbles est réalisé en utilisant des meuleuses à disques diamantés à vitesse variable. Il est vivement conseillé d'utiliser les meuleuses à une vitesse très basse, tout en respectant leur durée d'utilisation. Il est, par ailleurs, conseillé de ne pas utiliser des meuleuses dont les lames seraient usées. Pour obtenir une niche carrée dans laquelle loger des boîtiers électriques, il convient de réaliser 4 trous sur les arêtes du périmètre en utilisant une meuleuse à disques diamantés de faible diamètre (6-8 mm). L'utilisation de ces outils permettra de réduire les tensions internes des carreaux sur lesquels il sera ensuite possible d'effectuer les coupes de jointure avec un disque diamanté.

Bohren Bohrungen zur Durchführung von Kabeln sind mit geeigneten Diamantfräsen auf Bohrmaschinen mit variabler Drehzahl auszuführen; unter Berücksichtigung der erforderlichen Arbeitszeiten sollte stets eine relativ niedrige Werkzeugdrehzahl gewählt werden. Abgenutzte oder verschlissene Fräsen dürfen auf keinen Fall weiter verwendet werden. Zum Erhalt eines quadratischen Ausschnitts für die Installation von Stromdosen sind 4 Bohrungen an den umfangsseitigen Kanten unter Verwendung einer Diamantfräse mit kleinem Durchmesser (6-8 mm) auszuführen; auf diese Weise werden die inneren Spannungen der Fliese abgeschwächt, und es ist anschließend möglich, die Verbindungsschnitte zwischen den Bohrungen mit einer Diamantscheibe auszuführen.

La perforación El agujero redondo para pasar cables se hace con brocas diamantadas especiales montadas en taladros de velocidad variable; siempre es aconsejable emplear la herramienta a muy baja velocidad, respetando el tiempo necesario para realizar el trabajo. No se recomienda seguir usando la broca una vez que haya perdido su capacidad de rayado. Para obtener un agujero cuadrado donde instalar cajas de enchufe, hay que practicar 4 orificios en las esquinas del perímetro con una broca diamantada de diámetro pequeño (6-8 mm). Esto permite reducir las tensiones internas del azulejo sobre el cual posteriormente se podrá realizar los cortes de unión con un disco diamantado.

Сверление Изготовление отверстий для пропуска кабелей выполняется с использованием специальных алмазных фрез и дрелей с регулировкой скорости. Всегда рекомендуется использовать очень низкую скорость инструмента, соблюдая необходимую скорость выполнения работ. Не рекомендуется продолжать использовать фрезу после того, как она затупилась. Для выполнения квадратных вырезов для установки электрических коробок следует выполнить 4 отверстия по углам периметра, используя алмазную фрезу маленького диаметра (6-8 мм). Таким образом снижается внутреннее напряжение плитки, на которой потом можно будет выполнить резку между отверстиями алмазным диском.

EMILCERAMICA

CONDIZIONI GENERALI DI VENDITA E GARANZIE

GENERALITÀ

- 1) Le presenti condizioni generali costituiscono parte integrante di tutti i contratti di vendita a cui sia parte la Emilceramica
- 2) Salvo singoli casi in cui esse siano state derogate con espresse pattuizioni scritte a firma Emilceramica (qui di seguito denominata Venditore) costituiranno la disciplina esclusiva di tali vendite.
- 3) Se una o più parti delle presenti condizioni o dei singoli contratti che le includano risultassero invalide, le condizioni generali o particolari resteranno valide nel loro complesso; le parti invalide saranno sostituite con pattuizioni che si avvicinano quanto possibile alla originaria volontà delle parti.
- 4) Ogni offerta, ogni accettazione d'ordine ed ogni consegna da parte del VENDITORE si intende fatta alle presenti CONDIZIONI salvo espressa deroga scritta a firma del VENDITORE stesso; l'accettazione di tali offerte e la presa in consegna di PRODOTTI provenienti dal VENDITORE implica pertanto l'accettazione da parte degli acquirenti delle presenti CONDIZIONI integrate dalle eventuali pattuizioni scritte tra le parti.
- 5) La vendita si intende conclusa nel momento in cui il proponente o l'ordinante vengono a personale conoscenza del consenso della controparte; nel caso in cui tale consenso non sia stato espresso per iscritto potranno tener luogo della comunicazione scritta di consenso esclusivamente le comunicazioni scritte di avviso di merce pronta o, in mancanza, di spedizione della merce all'ordinante, o infine, in mancanza, la avvenuta prima consegna dei PRODOTTI all'ordinante e/o al suo trasportatore.
- 6) L'ordine non confermato per iscritto in nessun caso potrà intendersi accettato salvo esecuzione del medesimo da parte del VENDITORE mediante comunicazione scritta di merce pronta, di spedizione o mediante consegna dei PRODOTTI.
- 7) La consegna parziale di prodotti ordinati non comporta l'accettazione dell'intero ordine, ma solo di quella parte dei prodotti effettivamente consegnata.
- 8) Ogni eventuale offerta del VENDITORE si intende libera e senza impegni; se convenuta ferma per iscritto essa si intende valida per 14 giorni dalla sua spedizione.
- 9) L'esecuzione del contratto di vendita è in ogni caso convenzionalmente stabilita aver luogo nella sede del VENDITORE.

ORDINI/CONSEGNA

- 10) La consegna si intende eseguita presso il ns. stabilimento di Fiorano Modenese. La merce viaggia sempre a rischio e pericolo del compratore anche se spedita franco diporto. Sono quindi a carico del compratore anche i rischi di eventuali rotture e/o manomissioni o deterioramenti.
- 11) La consegna dei PRODOTTI HA LUOGO SECONDO LA FORMULA "Franco fabbrica Venditore"; tale formula, come anche le formule di resa che fossero convenute per iscritto in alternativa ad essa, fanno riferimento agli "Incoterms" 1953 della Camera di Commercio internazionale di Parigi, nell'edizione vigente al momento della vendita.
- 12) Nel caso in cui VENDITORE e acquirente convenissero per iscritto che la resa dei PRODOTTI abbia luogo "F.O.B. porto italiano", resta inteso che la scelta della nave e del porto italiano di partenza sarà a cura del VENDITORE che agirà per conto dell'acquirente.
- 13) I termini di consegna sono solamente indicativi e non impegnativi. Eventuali ritardi derivanti da qualsiasi causa non danno mai diritto al compratore ad annullare ordini o pretendere risarcimento di eventuali danni diretti o indiretti. Il VENDITORE si riserva espressamente di poter eseguire consegne parziali a fronte di ciascun ordine.
- 14) In caso di ritardo nelle consegne l'acquirente potrà, dopo una rituale messa in mora, ricusare ulteriori consegne e recedere dal contratto per la parte dei PRODOTTI non ancora consegnata. Il recesso dal contratto per la parte non consegnata a cagione di ritardo dà luogo al pagamento dei soli PRODOTTI effettivamente consegnati escluso ogni risarcimento o indennizzo.
- 15) Merci ordinate dal committente per errore o ordinate in eccedenza da parte del committente come pure di rimanenza, non vengono ritirati da parte della ns. società.
- 16) Misure, pesi e caratteristiche indicate nei ns. listini debbono intendersi indicativi.
- 17) Imballaggio su Euro palette con addebito.

FORZA MAGGIORE

- 18) Il VENDITORE non è responsabile nei confronti dell'acquirente per ogni inadempimento, compresa la mancata o ritardata consegna, causato da accadimenti al di fuori del suo ragionevole controllo quali, a titolo meramente indicativo, mancata o ritardata consegna dei materiali di lavorazione da parte dei fornitori, guasti agli impianti, scioperi e altre azioni sindacali, interruzione dei flussi energetici, sospensione o difficoltà nei trasporti.
- 19) Per giovarsi della presente clausola il VENDITORE dovrà comunicare l'insorgere della causa di forza maggiore all'acquirente al più tardi non oltre i 15 giorni dal suo verificarsi o dalla sua conoscenza. L'acquirente, trascorsi 45 gg. dalla data di prevista consegna senza aver ricevuto almeno il 75% in valore dell'ordine potrà, con propria comunicazione scritta, dichiarare il proprio recesso dalle consegne ancora da eseguirsi conseguendo la sola restituzione degli eventuali anticipi versati.

PAGAMENTI/PREZZI

- 20) I pagamenti della merce dovranno essere effettuati alla ns. sede in Fiorano Modenese; l'emissione di tratte o l'accettazione di effetti pagabili su altre piazze non implicano deroga a questa clausola.

Nel caso di ritardo nel pagamento totale od anche parziale di una fattura il venditore, salvi tutti gli altri suoi diritti, avrà facoltà di sospendere le ulteriori consegne anche se queste fossero dovute in dipendenza di altri contratti, di spiccare tratta per l'ammontera delle fatture scadute ed anche di pretendere l'immediato ed intero pagamento di tutto il materiale ordinato o di averlo in altro modo garantito.

In caso di ritardo nei pagamenti il VENDITORE avrà diritto a differrre le proprie consegne per un termine pari al ritardo nei pagamenti, qualunque ne sia l'importo e ciò sino al saldo di tali pagamenti e dei relativi interessi moratori.

Sui ritardati pagamenti decorrerà ad ogni modo, senza pregiudizio di ogni altra azione, l'interesse nella misura del 5%(cinque per cento) in più del tasso ufficiale di sconto dalla data di scadenza di ogni singola fattura, in ogni caso entro i limiti di cui alla L. 07/03/96 n° 11.108 ed eventuali successive modifiche.

- 21) Per la fatturazione valgono i prezzi di listino in vigore al giorno della consegna. In caso di un cambiamento dei prezzi tra la conferma d'ordine ed il giorno della fornitura abbiamo il diritto di adeguare i prezzi pattuiti alla nuova situazione.

GARANZIA

- 22) Le illustrazioni e le descrizioni dei cataloghi e dei listini, tutte le ns. pubblicazioni ed i campionari non sono impegnativi ma puramente indicativi.

Le dimensioni dei prodotti soggetti a calibro, in particolare dei pavimenti in gres-porcellanato, sono da intendersi con le tolleranze d'uso.

Le differenze di tonalità e le volute imperfezioni dei decori costituiscono una caratteristica positiva della produzione artistica.

I ns. materiali sono cotti ad alta temperatura quindi non possono essere garantite le riproduzioni esatte dei colori. È normale una semina nelle tonalità di tinta.

La garanzia della merce è limitata al solo materiale di 1° scelta. La ns. responsabilità è quindi espressamente esclusa per i materiali di 2° e 3° scelta o di stock e per le partite occasionali e/o speciali che si intendono venduti come "visti e piaciuti", senza alcuna garanzia.

I materiali in 1° scelta vengono garantiti conformi alle Norme ISO vigenti al momento della vendita; per quanto ivi non espressamente stabilito, vengono venduti con riferimento alle regole dell'arte ed alle consuetudini comunemente in uso nel settore ceramico ed ai consigli di utilizzo riportati nel ns. catalogo generale.

Condizione indispensabile per la validità ed efficacia delle garanzie è il rispetto delle norme di posa DIN 18352 e delle linee guida ISO/TC 189 WG 6 CEN TR 13548:2004; DIN 18202; DIN 18352; ANSI A108, A118, A136 vers. 2011.1.

Eventuali reclami per vizi e difetti della merce debbono essere denunciati, a pena di decadenza, per iscritto a mezzo lettera raccomandata da recapitarsi unicamente presso la sede amministrativa della Emilceramica in Fiorano Modenese entro il termine di decadenza di giorni otto decorrente dalla consegna del materiale, per i vizi palesi, e dalla scoperta per eventuali vizi occulti. In mancanza di quanto sopra, il compratore decade dal diritto alla garanzia ai sensi dell'art. 1495 C.C.

CONTESTAZIONI

- 23) Eventuali differenze di tonalità non costituiscono difetto del materiale e non possono essere denunciate come tali.

Qualora il reclamo sia tempestivo e risulti fondato, l'obbligazione del venditore è limitata alla accettazione in restituzione ed alla conseguente sostituzione della merce viziata o difettosa nel luogo stesso della fornitura primitiva, restando tassativamente rinunciati ed esclusi così la risoluzione del contratto come qualsiasi riduzione prezzo o risarcimento danni.

La responsabilità e la garanzia non si estendono in alcun modo ai materiali già posti in opera.

La sostituzione del materiale oggetto della contestazione non avrà luogo ove il compratore non ne abbia sospeso immediatamente l'impiego al momento della scoperta.

In ogni caso la garanzia massima non potrà superare un valore corrispondente a cinque volte il valore del materiale contestato con un massimo assoluto di e 10.000 (diecimila).

- 24) a) Le contestazioni per la merce mancante devono essere sollevate all'atto del ricevimento.
b) Altri sono da comunicare all'atto del ricevimento eventuali contestazioni per merce fornita in difformità a quanto convenuto.
c) Consegne di merce spedita sono, in ogni caso, da accettare da parte del committente. Consegne contenenti materiale contestato e/o materiale da rendere devono essere dal compratore immagazzinate in modo adeguato e al riparo di eventuali danni.
d) La garanzia per difetti occulti rimane esclusa o limitata nel caso di: rimozione non autorizzata dell'opera, posa non effettuata a regola d'arte, inosservanza di nostre prescrizioni e particolari direttive di applicazione atti del danneggiamento non ispirati alla normale diligenza che abbiano pregiudicato il contenimento dei danni. L'utilizzo di merce visibilmente difettosa o difforme all'ordinato implica accettazione delle caratteristiche di qualità ed esclude ogni eventuale contestazione.
e) La merce da noi fornita viene sostituita gratuitamente qualora caratteristiche garantite dovessero mancare e, in conseguenza di ciò, la merce risultasse inutilizzabile. Invece della sostituzione potrà anche venir concordato una riduzione del prezzo.
f) Per ogni indennizzo è obbligatoria la comprovazione che la merce sia stata trattata in modo adeguato e posata a regola d'arte. Nell'incertezza di ciò è richiesta una perizia tecnica. Nel caso che venga comprovato un danno e la ns. società sia tenuta ad un indennizzo, le spese occorrenti per tale perizia saranno a carico ns.
g) È imprescindibile, in ogni caso, che ci sia data la possibilità di controllare i difetti contestati nel loro stato originale. In questo caso deve essere concesso un sufficiente termine di tempo per la constatazione della causa del danno. Se questo diritto dovesse essere negato da parte del compratore decliniamo ogni responsabilità per l'indennizzo.
h) Il danneggiato ha l'obbligo di prendere tutte le misure necessarie allo scopo di contenere i danni al minimo. Inoltre deve assicurare un sufficiente numero di campioni della merce contestata.

- 25) I reclami riflettenti difetti riscontrati nei pezzi di una fornitura non infirmano la validità della stessa, ma restano limitati ai pezzi risultati difettosi.

- 26) Il venditore non è tenuto a risarcire danni diretti ed indiretti di qualsiasi natura derivati al compratore dall'impiego o dal mancato impiego del materiale difettoso.

- 27) Qualsiasi reclamo o contestazione non implica la sospensione od il rifiuto al pagamento delle fatture, pagamento che dovrà effettuarsi regolarmente ed integralmente nei termini convenuti.

DIRITTO APPLICABILE, FORO COMPETENTE, COMUNICAZIONI SCRITTE

- 28) I contratti di vendita all'esportazione cui sia parte il VENDITORE sono regolati dalla legge italiana e in particolare dalla Legge uniforme sulla vendita internazionale di cose mobili materiali e dalla Legge uniforme sulla formazione dei contratti di vendita internazionale di cose mobili materiali ove non derogate dalle presenti condizioni generali.

- 29) Foro competente per tutte le controversie relative alle vendite di PRODOTTI da parte del VENDITORE e dei rapporti connessi a tali vendite è esclusivamente quello della sede del VENDITORE.

- 30) I contratti di vendita regolati dalle presenti condizioni generali possono essere modificati solo mediante un documento o comunicazione scritta, firmati dai legali rappresentanti delle parti; ogni comunicazione scritta che abbia luogo in conformità alle presenti condizioni generali, sarà inviata a mezzo fax o raccomandata con avviso di ricevimento.

- 31) Nel caso di richiesta di reso merce per colpa non imputabile al VENDITORE verrà addebitata una penale pari al 15% del valore della merce da restituire.

GENERAL CONDITIONS OF SALE FOR EXPORT AND GUARANTEES

GENERAL

- 1) The present general conditions constitute an integral part of all sales contracts tiles entered into by Emilceramica
- 2) Except for the individual cases where the conditions have been expressly derogated by agreements in writing signed by Emilceramica (here in after called the SELLER) the conditions shall constitute the sole discipline of those sale contracts.
- 3) If any part of the present conditions or of the contracts submitted to the same, should result invalid, the other parts of the general conditions as well as the written modifications thereof shall remain valid; the invalid parts shall be substituted by agreements which shall, as much as legally possible, adhere to the original will of the parties.
- 4) Any offer, acceptance of offer, delivery by SELLER is understood to have been made at the present conditions except where specifically derogated by an instrument in writing carrying the Seller's signature; acceptance of any such offer, as well as taking delivery by purchaser of products from the SELLER, implies, therefore, the acceptance of the part of purchaser of the present conditions and of their modifications, if any, agreed in writing by the parties.
- 5) The sales contract is entered at the moment when the purchasing or selling party has personal knowledge of the other party's written consent to its proposal; in case such consent is not expressed in writing, only the written notice of products ready for shipment, or in its absence, of forwarding of products to purchaser or, in its absence by effected delivery of products to purchaser and/or to his haulier shall be in place of the consent written consent to be proposal to enter a sale contract.
- 6) The order which has not been confirmed in writing may not be deemed to have been accepted unless and whenever followed by written notice of products ready for shipment, or of forwarding of products to purchaser or by the delivery of the products them products themselves.
- 7) Partial delivery of the products ordered does not imply the acceptance by the seller of the whole order, the acceptance being limited to the part of products actually delivered.
- 8) Any and all offers by seller are deemed to be free and revocable; if agreed in writing to be irrevocable they shall be so for 14 days from the day on which the offer is sent to the purchaser.
- 9) The carrying out of any sale contract shall, in any case be deemed to take place at the seller's registered seat.

ORDERS/DELIVERY

- 10) It is intended that consignment is carried out at our factory at Fiorano Modenese (Modena). The merchandise will always travel at the purchaser's risk even if sent free of carriage. The purchaser will also bear the risk and expense of any eventual breakage and/or tampering and deterioration.

- 11) The delivery of products takes place in accordance with the term "ex-seller's work's"; said term, as well as other alternative delivery terms that may be agreed upon in writing, make reference to the Incoterms 1953 of the International Chamber of Commerce, Paris, in its edition current at the time of sale.

- 12) Should the parties agree in writing that the delivery be made "F.O.B. Italian port", it is understood that the choice of the ship and of the Italian port of shipment shall be made by the seller who shall act for the account of the purchaser.
- 13) The delivery terms are only indicative and not binding. Eventual delays resulting from any cause whatsoever will never give the purchaser the right to cancel , orders or to expect compensation for any direct or indirect damages.

- 14) In case of delay in delivery purchaser may, after having served -a formal and appropriate notice to the seller, refuse further deliveries of products and terminate the contract only in respect of those products which have not yet been delivered due to the delay. The contract termination in respect of undelivered products shall give rise to a payment obligation only in respect of products effectively delivered, any and all damages of indemnities for failure to deliver and/or termination being expressly excluded.

- 15) Goods ordered by the purchaser in error or in excess, or remainders left in his possession, will not be taken back to our company.

- 16) Sizes, weights and characteristics indicated in our lists must be taken as indicative

- 17) The seller shall not be responsible towards the purchaser for failure to comply to the contract terms, in all cases, including late delivery or failure to deliver, where its failure is due to events which are beyond its reasonable control such as, but not limited to, failure to deliver or late delivery by seller's suppliers of manufacturing materials, breaks in the manufacturing machinery, strikes and labour difficulties, interruption of energy flows, interruption or difficulties in transportation.

- 18) In order to benefit from the present clause the seller shall notify to the purchaser the occurrence of a case of "force majeure" within 15 days from its taking place or knowledge thereof. Purchaser may, after 45 days have elapsed from the day of originally agreed delivery and provided it has received less than the 75% in value of products ordered, terminate the contract in respect of undelivered products by sending a written notice; in this case purchaser shall receive back all monies paid in advance on account of undelivered products, all other indemnities being hereby excluded.

- 19) Packing on europallets is chargeable to customers.

PAYMENTS

- 20) Payments of the goods must be effected at our office at Fiorano Modenese (Modena); the issue of drafts or the acceptance of bills payable in other places will not imply a derogation from this cause.

In the case of delay in the total or partial payment of an invoice, the vendor, reserving all his other rights, may suspend further consignments, even if these may be due in consequence of other contracts draw a bill for the amount of the due invoices, and also claim the immediate and entire payment of all material ordered, or have such payment guaranteed in some other way. In case of purchaser's delay in payments, seller may postpone its deliveries for a term equal to the delay in payments, whatever the amount, up to the full settlement of capital and delay interests.

Interest at 5% (five percent) will be charged on late payments, without prejudicing any other action, and in addition the official discount rate from the due date of every invoice will be payable, in any case within the limits of the L. 07/03/96 11.108 and possible followings amendments.

- 21) The prices in the invoices will be those listed in the price list current at the date of consignment. In the case of a change in prices between the confirmation of the order and the date of supply, we reserve the right to adjust the agreed prices to the new situation.

EMILCERAMICA

WARRANTY

- 22) The illustrations and descriptions in the catalogues and price lists, as well as all our literature and samples, are to be considered indicative and provided purely for illustrative purposes.

The product dimensions are nominal and, particularly for the porcelain stoneware floor tiles, are subject to the allowed tolerances for use.

Shade differences and decors created alteration are natural features of the artistic production.

Our materials are fired at high temperature therefore exact colour reproduction cannot be guaranteed. A certain seeding in the colour tone is normal.

The warranty on the goods is restricted to 1st grade materials. We therefore expressly decline responsibility for 2nd and 3rd choice or stock materials as well as for occasional and/or special lots that are sold subject to "approval on sight" and without any form of warranty.

The 1st choice materials are guaranteed to conform to the ISO standards in force at the time of sale; for all matters not explicitly specified elsewhere, they are sold with reference to the common practices and workmanlike standards of the ceramics sector, and the recommendations for use provided in our general catalogue.

An essential condition for the validity and effectiveness of the warranty is compliance with the DIN 18352 laying standards and the ISO/TC 189 WG 6 CEN TR 13548:2004; DIN 18202; DIN 18352; ANSI A108, A118, A136 vers. 2011.1 guidelines.

Any claims for defects in materials and workmanship must be notified in writing, to avert invalidation, by registered letter addressed exclusively to the headquarters of Emilceramica in Fiorano Modenese, within 8 days from the date of material delivery for manifest defects, or from the date of their discovery for hidden defects. Failure to comply with the above shall invalidate the warranty according to art. 1495 of the civil code.

COMPLAINTS

- 23) Any differences in shade shall not constitute a defect in the material and cannot be claimed as such.

If the claim is notified in time and proves to be justified, the vendor's obligation shall be limited to accepting the returns and subsequently replacing the flawed or defective goods in the same place as the original supply, with any resolution of the contract, reductions in price or compensation for damages being categorically excluded and renounced.

The responsibility and the warranty shall in no way be extended to materials that have already been laid.

The materials implicated in the claim shall not be replaced if the purchaser fails to immediately cease using the material upon discovering the defect.

In any case, the maximum warranty shall not exceed a value equal to five times the value of the defective materials, with an upper limit of e 10,000.00 (ten thousand).

- 24) a) Complaints for missing goods must be made at the time the goods are received.

b) Complaints of supply of goods not in conformity with those agreed must also be made at the moment they are received.

c) Delivery of goods sent must in any case be accepted by the purchaser. Any delivery containing contestable material and/or materials to be returned to our company must be stored by the purchaser in an adequate way and so as to be protected from eventual damage.,

d) The guarantee regarding hidden defects will be excluded or limited in the following cases: unauthorised removal of the work; where the laying has not been carried out according to standard; where our regulations and special directives as to application have not been observed; acts of damage where there has been a lack of the normal diligence which might have limited the eventual damage. The use of visibly defective goods implies the acceptance of the inferior quality and excludes any later complaint.

e) The goods supplied by us will be exchanged free of charge whenever a guaranteed characteristic is found to be missing and consequently the goods are unusable. A reduction in price may be agreed on instead of the replacement of defective goods.

f) Proof that the goods have been treated in an adequate manner and that the tiles have been laid according to standard is obligatory in any claim for indemnity.

In doubtful case an appraisalment is necessary. In the case that a damage is evidenced and our company must pay a compensation, the expenses of the appraisalment will be at our own charge.

g) We must be given the opportunity to check the defects subject of any complaint in their original state. In such case we must be granted the time to ascertain the cause of the damage. If this right is denied us by the purchaser, we decline every responsibility for any indemnity claimed.

h) The damaged party will be obliged to take every measure necessary to limit the damage to minimum. And further, he must ensure the availability of a sufficient number of samples of the contested goods.

25) Complaints regarding defects found in certain pieces of a supply will not affect the validity of the same, but will remain limited to the defective items.

26) The vendor is not required to pay direct or indirect damages of any kind arising out of the use or failure to use defective materials.

27) Any complaints or protests will not give rise to a suspension or refusal of the payment of any invoice, which must be effected completely and regularly according to the terms agreed.

APPLICABLE LAW, COMPETENT JURISDICTION, WRITTEN COMMUNICATIONS

- 28) The export sales contracts entered into by the seller are governed by the law of Italy and in particular by the Uniform Law on the International Sale of Goods and by the Uniform Law on the Formation of Contracts for the international sale of goods unless derogated by the present general conditions.

29) The competent jurisdiction in respect of all controversies relating to the sales of products by seller and to all legal relationships entered in connection therewith, shall be exclusively the one of the seller's registered seat.

30) Any-and all sale contracts based on the present General conditions may be modified only by an instrument in writing or by a communication in writing, signed by an authorised representative of the parties; any written communication and notice to be given in compliance with the present general conditions shall be either in the form of a telex or in the form of a registered letter, return receipt requested.

31) Emilceramica want to inform you that in case of demand for rendered goods for not imputable guilt to the VENDOR penal par to 15% of the value of the goods will come debited one to give back.

EMILCERAMICA

CONDITIONS GENERALES DE VENTE A L'EXPORTATION ET DE GARANTIE

GENERALITES

- Les présentes conditions générales font partie intégrante de tous les contrats de vente à l'exportation des carreau de faïence et céramiques dans lesquels soit partie la Emilceramica
- Sauf les cas exceptionnels dans lesquels ces conditions soient dérogées par des accords particuliers, écrits et signés par Emilceramica (ci-après dénommée VENDEUR) elles constitueront la discipline exclusive de toutes ventes.
- Si une ou plusieurs parties des présentes conditions, ou des contrats particuliers qui les incluent, ne s'averaient pas valables, les conditions générales ou particulières et les modifications y relatives, resteront valables dans leur ensemble. Les parties qui ne seront pas valables, seront substituées par des conventions qui se rapprochent, autant que possible, à la volonté originaires des parties.
- Chaque offre, chaque acceptation de commande et chaque livraison de la part du VENDEUR s'entend faite aux présentes CONDITIONS sauf dérogation expresse écrite et signée par le VENDEUR. L'acceptation de ces offres et la prise de possession des PRODUITS provenant du VENDEUR implique donc l'acceptation, de la part des acheteurs, des présentes CONDITIONS, intégrées par d'éventuelles conventions écrites entre les parties.
- La vente s'entend conclue au moment même où le proposant ou celui qui commande connaissent le consentement de l'autre partie; au cas où ce consentement n'aurait pas été exprimé par écrit, au lieu de la communication écrite du consentement, seront prises en considération exclusivement les communications d'avis de marchandise prête ou, à défaut, l'expédition de la marchandise à celui qui l'a commandé, ou à défaut, lors de la première livraison à l'acheteur et/ou son transporteur.
- La commande non confirmée par écrit, ne pourra, en aucun cas, être considérée comme acceptée, sauf au cas d'exécution de celle-ci de la part du VENDEUR par communication écrite de marchandise prête, d'expédition, ou par la livraison des PRODUITS.
- Une livraison partielle des PRODUITS commandés ne comporte pas l'acceptation de la part du VENDEUR de l'ensemble de l'ordre, mais seulement de la partie de PRODUITS effectivement livrés.
- Toute offre éventuelle du VENDEUR s'entend libre et sans engagement; si elle est convenue ferme par écrit, elle reste valable 14 jours à compter de la date d'expédition.
- Il est convenu que l'exécution du contrat de vente a lieu au siège du VENDEUR.

COMMANDES/LIVRAISONS

- La livraison s'entend effectuée à notre établissement de Fiorano Modenese. La marchandise voyage toujours aux risques et périls de l'acheteur même si elle est expédiée franco port. Par conséquent, les risques d'éventuelles cassures et/ou endommagements et détériorations sont à charge de l'acheteur.
- La livraison des PRODUITS a lieu selon la formule "Franco usine du VENDEUR". Cette formule, aussi bien que les autres formules de livraison qui auraient été convenues par écrit en alternative à celle-ci, font référence aux "Incoterms" 1953 de la Chambre de Commerce Internationale de Paris, dans l'édition en vigueur lors de la vente.
- Au cas où le VENDEUR et l'acheteur conviendraient par écrit que la livraison des PRODUITS ait lieu "F.O.B. port italien", il est entendu que le VENDEUR aura le choix du navire et du port italien de départ et qu'il agira pour le compte de l'acheteur.
- Les délais de livraison sont seulement indicatifs et n'engagent donc pas le fabricant. Les éventuels retards dus à toute cause ne donne jamais le droit à l'acheteur d'annuler les commandes ou de prétendre une indemnisation pour les éventuels dommages directs ou indirects. Le VENDEUR se réserve le droit d'effectuer des livraisons partielles pour chaque commande.
- En cas de retard dans les livraisons, l'acheteur pourra, après avoir envoyé une sommation au VENDEUR, refuser d'ultérieures livraisons et résilier le contrat avec référence à la seule partie des PRODUITS n'ayant pas encore été livrée. La résiliation du contrat pour la partie non livrée en raison du retard, donne lieu au paiement des seuls PRODUITS effectivement livrés à l'exclusion de tous dommages-intérêts ou indemnité de toute sorte.
- Si les commandes faites par l'acheteur sont erronées ou excessives, les marchandises ne seront pas reprises par notre société; cette condition est valable même en cas de marchandises restantes.
- Les mesures, poids et caractéristiques indiqués dans nos.catalogues, dépliants et tarifs sont à titre indicatif.
- Produits livrés sur Euro Palettes payantes.

FORCE MAJEUR

- Le VENDEUR n'est pas responsable vis à vis de l'acheteur pour tout manquement y compris le manquement et le retard de livraison causés par les événements hors de son raisonnable contrôle tels que, à titre purement indicatif, livraison manquée ou retardée des matériaux de travail de la part des fournisseurs, défaut des installations, grèves et autres actions syndicales, interruptions des flux énergétiques suspensions ou difficultés dans les transports.
- Pour jouir de la présente clause, le VENDEUR devra communiquer à l'acheteur son manquement pour cause de force majeure, au plus tard dans les 15 jours à partir de l'évènement ou dès qu'il en ai connaissance. L'acheteur, passé le délai de 45 jours à compter de la date prévue pour la livraison, sans avoir reçu au moins le 75% de la valeur de la commande pourra, par communication écrite, résilier le contrat par rapport aux livraisons restantes en ayant droit à la seule restitution des éventuels acomptes versés.

PAYEMENTS / PRIX

- Les paiements de la marchandise devront être effectués à notre siège de Fiorano Modenese: l'émission de traites ou l'acceptation d'effets déplacés n'impliquent pas de dérogation à cette clause. En cas de retard dans le paiement total ou partiel d'une facture, le vendeur, en plus de tous les autres droits, aura la faculté de - suspendre les livraisons suivantes même si elles étaient dues en conséquence d'autres contrats: il pourra aussi tirer une traite pour le montant des factures échues, prétendre le paiement immédiat et total de toute la marchandise commandée ou exiger, d'une autre façon, la garantie du paiement.

En cas de retard dans les paiements, le VENDEUR aura le droit de retarder ses livraisons d'un délai équivalent au retard du paiement, quelque soit le montant; cela, jusqu'au solde des paiements et des intérêts moratoires relatifs y paiement, quelque soit le montant; cela, jusqu'au solde des paiements et des intérêts moratoires relatifs. De toute façon, sur les paiements retardés il courra, sans préjudice à toute autre action, un intérêt de 5% (cinq pour cent) en plus du taux officiel d'escompte, et ceci, à partir de la date d'échéance de chaque facture, en tout cas dans les limites imposées par la Loi 07/03/96 11.108 et éventuelles modifications.

- Les prix facturés sont ceux du tarif en vigueur au jour de la livraison. En cas de changement des prix entre la confirmation de commande et le jour de la fourniture, nous avons le droit d'adapter les prix stipulés à la nouvelle situation.

GARANTIE

- Les illustrations et les descriptions des catalogues et des tarifs, toutes nos publications et les échantillons ne nous engagent en rien mais sont purement indicatifs. Les dimensions des produits sujets à calibrage, en particulier des carrelages en grès cérame, s'entendent avec les tolérances d'usage. Toutes différences de tonalité et imperfections des décors rentrent dans les tolérance liée à une production artistique. Nos matériaux sont cuits à une température élevée, et par conséquent, nous ne pouvons pas garantir les reproductions exactes des couleurs. La garantie de la marchandises est limitée uniquement au matériau de 1er choix. Nous ne sommes absolument pas responsables pour les matériaux de 2e et de 3e choix ou de stock et pour les lots occasionnels et/ou spéciaux qui s'entendent vendus comme "vus et acceptés", sans aucune garantie. Les matériaux de 1er choix sont garantis conformes aux normes ISO en vigueur au moment de la vente; pour ce qui n'est pas expressément fixé, ils sont vendus avec référence aux règles de l'art et selon l'usage du secteur céramique et aux conseils d'utilisation reportés dans notre catalogue général. Le respect des normes de pose DIN 18352 et des lignes de conduite ISO/TC 189 WG 6 CEN TR 13548:2004; DIN 18202; DIN 18352; ANSI A108, A118, A136 vers. 2011.1 est la condition indispensable pour la validité et l'efficacité des garanties. D'éventuelles réclamations pour vices et défauts de la marchandise doivent être faites, sous peine de déchéance, par écrit par lettre recommandée à faire parvenir uniquement au siège administratif "Emilceramica" à Fiorano Modenese dans le délai de huit jours à compter de la livraison du matériau, pour les vices évidents, et de la découverte pour d'éventuels vices cachés. Dans le cas contraire, la garantie pour l'acheteur n'est plus valable aux termes de l'art. 1495 C.C.

RECLAMATIONS

- D'éventuelles différences de tons ne constituent pas un défaut du matériau et ne peuvent pas être dénoncées comme tels. Si la réclamation est faite en temps utile et est avec fondement, l'obligation du vendeur est limitée à l'acceptation de la restitution et donc au remplacement de la marchandise viciée ou défectueuse dans le lieu même de la fourniture d'origine. La résiliation du contrat ainsi que toute réduction du prix ou versement de dommages-intérêts sont donc formellement exclus. La responsabilité et la garantie ne s'étendent en aucun cas aux matériaux déjà posés. Le remplacement du matériau objet du différend ne se fera pas si l'acheteur n'a pas immédiatement suspendu son utilisation au moment de la découverte. La garantie maximum ne pourra pas dépasser une valeur qui correspond à cinq fois la valeur du matériau objet du différend, avec un maximum absolu de e 10.000,00 (dix milles euros).

- Les contestations pour la marchandise manquante doivent être soulevées à l'acte de la réception.
 - De même il faut communiquer à l'acte de la réception les éventuelles contestations pour marchandise fournie différemment par rapport à ce qui avait été convenu.
 - Les livraisons de marchandise expédiée doivent obligatoirement être acceptées par l'acheteur. Les livraisons comprenant du materiet contesté et/ou du matériel à rendre doivent être emmagasinées par l'acheteur de manière adéquate et à l'abri d'éventuels dégâts.
 - La garantie pour défaut occultes est excluse ou limitée dans les cas suivants: déplacement non autorisé de la marchandise, pose non effectuée en bonne et due forme; inobservation de nos prescriptions et de nos précisions directives d'application, actes d'endommagement qui pourraient porter préjudice à la contenance des dégâts. L'emploi de marchandise visiblement défectueuse implique une acceptation des caractéristiques de qualité et exclu toute éventuelle contestation.
 - Nous remplaçons gratuitement la marchandise fournie au cas où les caractéristiques garanties manqueraient et qu'en conséquence cette marchandise sera inutilisable.
 - Une réduction du prix pourra être concordée à la place du remplacement de la marchandise.
 - Pour obtenir toute indemnisation, il est obligatoire de prouver que la marchandise a été traitée de manière adéquate et posée en bonne et due forme. Dans le doute, une expertise technique sera demandée. Au cas où un dommage serait prouvé et que, par conséquent, notre société serait obligée de payer une indemnisation, les frais nécessaires à la dite expertise seraient à notre charge.
 - Il doit nous être permis absolument de contrôler les défauts contestés dans leur état original. Dans ce cas, il faudra nous concéder un délai suffisant pour effectuer la constatation de la cause du dommage. Si ce droit nous est nié par l'acheteur, nous déclinons toute responsabilité en ce qui concerne l'indemnisation.
 - L'acheteur qui aura subi un dommage, sera obligé de prendre toutes les mesures nécessaires pour limiter le plus possible les dégâts. De plus, il devra assurer un nombre suffisant d'échantillons de la marchandise contestée.

- Les réclamations concernant des défauts trouvés dans les pièces d'une fourniture n'infirmnt pas cette dernière mais seront limitées aux pièces défectueuses.
- Le vendeur n'est pas obligé de payer à l'acheteur les dommages directs et indirects de toute nature qui dériveraient de l'emploi ou du non-emploi de la marchandise défectueuse.
- Toute réclamation ou contestation n'implique pas la suspension ou le refus du paiement des factures: ce paiement devra être effectué régulièrement et totalement dans les délais convenus.

DROIT APPLICABLE - TRIBUNAL COMPETENT - COMMUNICATIONS ECRITES

- Les contrats de vente à l'exportation dont fait partie le VENDEUR, sont régis par la loi italienne et en particulier par la Loi Uniforme sur la Vente Internationale de biens, meubles matériaux et par la Loi Uniforme sur la Formation des Contrats Internationaux de Vente de bien, meubles matériaux au cas où elles ne seraient pas dérogées par les présentes conditions générales.
- Tribunal compétent pour tous les litiges dérivant des ventes des PRODUITS de la part du VENDEUR et des rapports y découlant est celui du siège du VENDEUR uniquement.
- Les contrats de vente réglés par les présentes conditions générales de vente peuvent être modifiés uniquement par un document ou une communication écrite, signée par les représentants légaux des parties; chaque communication écrite, qui a lieu conformément aux présentes conditions générales, sera envoyée par fax ou lettre recommandée avec avis de réception.
- En cas de litige ayant pour origine un défaut de paiement notre société pourra saisir au choix soit les juridictions du domicile du défendeur soit les tribunaux de Paris, nonobstant toute clause contraire. En cas, en revanche de différent d'ordre technique, il est convenu de demander dans un premier temps l'avis de la Chambre de Commerce Franco-italienne de Paris; en cas de désaccord persistant, la loi italienne sera seule applicable et le Tribunal Civil de Modena sera seul compétent.
- En ce qui concerne les retours du matériel ou la responsabilité du fabricant n'est pas mis en cause une pénalité du 15 % du valeur de la marchandise sera débité.

ALLGEMEINE VERKAUFS - UND GARANTIEBEDINGUNGEN

ALLGEMEINE ANGABEN

- Die vorliegenden allgemeinen Bedingungen stellen einen integrierenden Bestandteil aller Verkaufsverträge dar, die mit der Firma Emilceramica abgeschlossen werden.
- Mit Ausnahme von Einzelfällen, wo ausdrücklich in Form von schriftlichen, von Emilceramica (nachstehend Verkäufer genannt) unterzeichneten Vereinbarungen davon Abstand genommen wird, stellen diese Bedingungen die ausschliessliche Grundlage für die Regelung dieser Verträge dar.
- Falls eine oder mehrere Klauseln der vorliegenden Bedingungen oder der einzelnen Verträge, die sie beinhalten, sich als ungültig erweisen sollten, bleiben die Allgemeinen - oder Sonderbedingungen insgesamt gültig; die ungültig gewordenen Abschnitte werden durch Vereinbarungen ersetzt, die sich soweit wie möglich den ursprünglichen Absichten der Vertragspartner annähern.
- Jedes Angebot, jede Auftragsbestätigung und jede Lieferung von seiten des Verkäufers verstehen sich als unter Zugrundelegung der vorliegenden Bedingungen vorgenommen, falls der Verkäufer nicht selbst diese Abweichungen schriftlich bestätigt hat; derartige Auftragsbestätigungen und die Entgegennahme von durch den Verkäufer gelieferten Produkten stellt daher die Annahme der vorliegenden Bedingungen durch die Käufer dar, integriert durch eventuelle Sondervereinbarungen zwischen den Parteien.
- Das Kaufgeschäft wird als abgeschlossen betrachtet, sobald der zukünftige Verkäufer oder der zukünftige Käufer persönlich über die Zustimmung der Gegenpartei informiert wird; falls dieses Einverständnis nicht schriftlich zum Ausdruck gebracht wurde, können anstelle der schriftlichen Mitteilung des Einverständnisses lediglich die schriftliche Mitteilung, dass die Ware versandbereit ist, oder falls dies nicht geschieht, die Ankundigung des Warenversandes an die Auftraggeber, oder schliesslich, falls dies nicht geschieht, die erfolgte erste Auslieferung der Produkte an den Auftraggeber und/oder an seinen Transporteur, treten.
- Der nicht bestätigte Auftrag kann in keinem Falle als akzeptiert betrachtet werden, mit Ausnahme des Falles in dem dieser durch den Verkäufer ausgeführt wurde, durch schriftliche Mitteilung, dass die Ware versandbereit ist, oder durch Versand oder Auslieferung der Produkte.
- Die Teillieferung der bestellten Produkte stellt keine Annahme des Gesamtauftrages dar, sondern lediglich des tatsächlich gelieferten Teiles.
- Jedes eventuelle Angebot des Verkäufers versteht sich freibleibend und unverbindlich; falls das Angebot verbindlich vereinbart wurde, versteht es sich für einen Zeitraum von 14 Tagen nach der Abgabe.
- Der Verkaufsvertragsort ist auf jeden Fall der Sitz des Verkäufers.

AUFTRÄGE / LIEFERUNGEN

- Die Auslieferung erfolgt in unserem Werk in Fiorano Modenese (MO).
- Die Auslieferung der Produkte versteht sich "ab Werk des Verkäufers"; diese Formel, wie auch die Uebergabebedingungen, falls schriftlich alternativ dazu vereinbart, beziehen sich auf die "Incoterms" 1953 der Internationalen Handelskammer in Paris, in der zum Zeitpunkt des Vertragsabschlusses gültigen Fassung.
- Falls der Verkäufer und der Käufer schriftlich vereinbaren, dass die Uebergabe der Produkte "F.O.B. italienischer Hafen" sein soll, versteht es sich, dass die Wahl des Schiffes und des italienischen Versandhafens vom Verkäufer getroffen wird, der im Auftrag des Käufers handelt.
- Die Lieferzeitangaben sind hinweisend nicht bindend. Eventuelle Verspätungen aus irgendwelchem Grunde geben kein Anrecht, seitens des Käufers die Aufträge zu stornieren oder eine Entschädigung für eventuelle direkte oder indirekte Schäden zu fordern.
- Bei Lieferverzug kann der Käufer nachdem er eine Nachfrist gesetzt hat, weitere Lieferungen zurückweisen und von dem Vertrag zurücktreten, bezüglich der noch nicht ausgelieferten Produkte. Das Zurücktreten von dem Vertrag bezüglich der noch nicht ausgelieferten Teile auf Grund Lieferverzugs, verpflichtet lediglich zur Zahlung der tatsächlich ausgelieferten Produkte, wobei jede Art Schadenerstattung oder Schadloshaltung ausgeschlossen sind.
- Waren, die vom Käufer falsch oder zuviel bestellt werden, oder Lieferungsreste, werden von Lieferanten nicht übernommen.
- Maßangaben, Gewichte und Eigenschaften der Listen sind hinweisend und nicht bindend.
- Verpackung auf Euro Palette gegen berechnung.

HÖHERE GEWALT

- Der Verkäufer hat gegenüber dem Käufer keine Verantwortung für Nichteinhaltung des Kaufvertrages, einschliesslich der nicht oder zu spät erfolgten Lieferung, falls dies durch Höhere Gewalt verursacht wurde, wie zum Beispiel unter anderem, die nicht oder zu spät erfolgte Lieferung von Verarbeitungsmaterial durch Zulieferanten, Schäden an den Produktionsanlagen, Streik oder andere gewerkschaftliche Aktionen, Unterbrechung der Energieversorgung, Unterbrechung oder Schwierigkeiten beim Transport.
- Um sich auf vorliegende Klausel berufen zu können, muss der Verkäufer das Auftreten der auf höhere Gewalt zurückzuführenden Umstände dem Käufer nicht später als 15 Tage nach deren Auftreten oder nachdem er davon informiert wurde, mitteilen. Falls 45 Tage nach der vorgesehenen Lieferzeit nicht wenigstens 75% des Auftragswertes ausgeliefert wurden, kann der Käufer durch schriftliche Mitteilung seinen Rücktritt von dem Kaufvertrag bezüglich der noch zu liefernden Mengen erklären, worauf er lediglich Anspruch auf Rückerstattung eventuell geleisteter Anzahlungen hat.

BEZAHLUNGEN

- Alle Zahlungen sind an unsere Firma in Fiorano Modenese (MO) zu leisten; die Ausstellung von Akzepten oder die Annahme von Zahlungswechseln anderer Zahlungsorte gelten nicht als Abweichung von dieser Bedingung.

Im Falle verspäteter Gesamt- oder Teilzahlung einer Rechnung kann der Lieferant, unter Beibehaltung aller weiteren Rechte, weitere Lieferungen unterbrechen, auch wenn diese auf Grund anderer Verkäufe erfolgt sind, sowie Akzept über den Gesamtbetrag ausstellen, der fällig ist, sowie die Zahlung des gesamten Materials verlangen, das in Auftrag ist oder die Zahlung desselben auf andere Weise garantiert zu bekommen.

Bei Zahlungsverzug hat der Verkäufer das Recht seine Lieferungen um den gleichen Zeitraum der Verpätung der Zahlungen zu verschieben, unabhängig vom Betrag und dies bis diese Zahlungen sowie die entsprechenden Verzugszinsen geleistet wurden.

Für verspätete Zahlungen werden auf alle Fälle, ohne Einschränkung weiterer Forderungen, Zinsen berechnet, die 5% über den offiziellen Zinssätzen liegen, die bei Fälligkeit der einzelnen Rechnungen gültig sind und auf jedem Fall innerhalb des Gesetzes L. 07/03/96 11,108 und jeglicher darauf Folgender Änderung gültig sind.

- Für die Berechnung gilt die Liste, die am Tag der Lieferung gültig ist. Im Falle einer Preisänderung in der Zeit zwischen Auftragsbestätigung und Liefertag halten wir uns das Recht vor, die abgestimmten Preise der neuen Lage anzugleichen.

EMILCERAMICA

GARANTIE

- Die Abbildungen und Beschreibungen in den Katalogen und Preislisten sowie all unsere Veröffentlichungen und Muster sind nicht als verbindliche, sondern als Richtungsweisend zu betrachten. Für die Größen der Produkte, die kalibriert sind, vor allem die der Fußböden aus Feinsteinzeug, gelten die üblichen Toleranzwerte. Die Tonalität Unterschied und die berechtigte Kleine Mangel der Dekore gehoeren an die Kunstliche Charakter der Ware. Unser Material wird bei hohen Temperaturen gebrannt. Eine ständig genaue Wiedergabe der Farbtöne kann daher nicht gewährleistet werden. Eine Farbstrreuung innerhalb eines Farbtons gilt als normal. Die Garantie der Ware beschränkt sich lediglich auf das Material erster Wahl. Wir haften daher ausdrücklich nicht für die Materialien der zweiten und dritten Wahl oder von Warenbeständen und auch nicht für gelegentliche und/oder spezielle Posten, die als „gesehen und gefallen“ ohne irgendeine Art Garantie verkauft werden. Für die Materialien der ersten Wahl werden die Garantien übernommen, die den zum Zeitpunkt des Verkaufs geltenden ISO-Normen entsprechen; sofern nicht ausdrücklich anders vereinbart, werden die Materialien unter Verweisung auf die fachgerechte Verwendung und die in der Keramikbranche allgemein üblichen Gepflogenheiten sowie mit den Empfehlungen zum Gebrauch, die in unserem allgemeinen Katalog aufgeführt werden, verkauft. Unerlässliche Bedingung für die Gültigkeit und Wirksamkeit der Garantien ist die Beachtung der Normen zur Verlegung DIN 18352 und der Richtlinien ISO/TC 189 WG 6 CEN TR 13548:2004; DIN 18202; DIN 18352; ANSI A108, A118, A136 vers. 2011.1.
- Eventuelle Reklamationen wegen Fehlern und Mängeln der Ware sind schriftlich mittels eines Einschreibens, das ausschließlich an den Verwaltungssitz von Emilceramica in Fiorano Modenese zu senden ist, bei sichtbaren Mängeln innerhalb einer Frist von acht Tagen, die auf die Lieferung des Materials folgen, und bei möglichen verborgenen Mängeln innerhalb derselben Frist ab deren Entdeckung zu melden, ansonsten erlischt für den Käufer der Anspruch auf Garantie gemäß Art. 1495 CC (italienisches Bürgerliches Gesetzbuch).

BEANSTANDUNGEN

- Mögliche Unterschiede im Farbton stellen keine Materialfehler dar und können nicht als solche angezeigt werden. Sofern die Reklamation rechtzeitig erfolgt ist und sich als begründet herausstellt, beschränkt sich die Verpflichtung des Verkäufers auf die Annahme zur Erstattung und der darauf folgenden Ersetzung der mangel- oder fehlerhaften Ware an dem Ort der ursprünglichen Lieferung, wobei so auf die Auflösung des Vertrags sowie auf jede Art Preisnachlass oder Schadenersatz ausdrücklich verzichtet wird bzw. dies alles ausgeschlossen wird. Die Haftung und Garantie erstrecken sich auf keinen Fall auf die bereits verlegten Materialien. Die Ersetzung des beanstandeten Materials erfolgt nicht, wenn der Käufer im Zeitpunkt der Entdeckung nicht unverzüglich die Verwendung dieses Materials eingestellt hat. In jedem Fall kann die Höchsthaftung nicht höher sein als ein Wert, der fünf Mal so hoch ist wie der Wert des beanstandeten Materials, sie beträgt höchstens e 10.000,00 (Zehntausend).
- Die Beanstandungen bezüglich fehlender Ware müssen innerhalb der Zeit des Warenerhaltes vorgebracht werden.
 - Ebenso bei Warenerhalt müssen eventuelle Beanstandungen der gelieferten Ware vorgebracht werden, die unterschiedlich in Bezug auf die vereinbarte Lieferung ist.
 - Gelieferte Ware muß von Kunden auf alle Fälle angenommen werden. Lieferungen mit beanstandetem Material und/oder zurückzulieferndem Material müssen vom Käufer so eingelagert werden, daß keine Beschädigungen entstehen können. .
 - Die Garantie für unsichtbare Fehler gilt nicht oder ist beschränkt bei folgenden Fällen: nicht genehmigte Entfernung des Materials; nicht fachgemäss vorgenommene Verlegung, Nichtbeachtung unserer Vorschriften und besonderen Benutzungsangaben, Beschädigung wegen ungenügender Sorgfalt.
- Die Verwendung von sichtlich defektem Material setzt die Annahme desselben voraus, was die Qualitätseigenschaften betrifft, und schliesst daher jeglichen Garantieanspruch aus.
- Die von uns gelieferte Ware wird kostenlos ersetzt, sofern die von uns garantierten Eigenschaften nicht erfüllt sind und die Ware deshalb nicht verwendungsfähig ist.
- Für jeden Schadenersatz ist Voraussetzung, daß das Material fachgerecht behandelt und verlegt wurde. Im Zweifel wird ein technisches Gutachten verlangt. Im Falle, dass dementsprechend eine Garantieübernahme unsererseits gültig wird, gehen die Kosten für dieses Gutachten zu unseren Lasten.
- Die Fehler müssen unbeding für uns in ihrem Originalzustand kontrollierbar sein. Deshalb ist uns genügend Zeit zuzugestehen, um die Beanstandung überprüfen zu können. Sollte dieses Recht seitens des Käufers verneint werden, lehnen wir jegliche Verantwortung über Schadenersatz ab.
- Der Geschädigte hat alle Maßnahmen zu treffen, den Schaden so gering wie möglich zu halten. Ausserdem muß er für eine genügende Anzahl der beanstandeten Waren sorgen.

- Reklamationen, die sich auf Fliesen aus einer Lieferung beziehen, machen diese Lieferung nicht ungültig, sondern beschränken sich ausschliesslich auf die fehlerhaften Fliesen.
- Das Lieferwerk ist nicht gehalten, für Schäden gleich welcher Natur, die dem Auftraggeber durch Verwendung fehlerhaften Materials oder dessen Nichtverwendung direkt oder indirekt entstanden sind, aufzukommen.
- Eine Reklamation oder Beanstandung gleich welcher Art berechtigt nicht zur Zahlungseinstellung einer Rechnung oder der Verweigerung der entsprechenden Zahlung. Der Rechnungsausgleich muss vielmehr für den gesamten Betrag und innerhalb der vereinbarten Zahlungsfrist erfolgen.

ANWENDBARES RECHT, GERICHTSSTAND, SCHRIFTLICHE MITTELUNGEN

- Exportverkaufsgeschäfte an denen der Verkäufer beteiligt ist, werden durch das italienische Recht geregelt und insbesondere durch das Einheitsgesetz zur Regelung des internationalen Verkaufes beweglicher Güter, und durch das Einheitsgesetz zur Regelung der internationalen Kaufgeschäfte für bewegliche Güter, falls die vorliegenden allgemeinen Verkaufsbedingungen diese nicht aufheben.
- Zuständiger Gerichtsstand für alle Streitfälle bezüglich des Verkaufs der Produkte durch den Verkäufer und bezüglich der Geschäftsbeziehungen in Zusammenhang mit diesen Verkäufen, ist ausschliesslich der Firmensitz des Verkäufers.
- Die von den vorliegenden allgemeinen Lieferbedingungen geregelten Kaufverträge können lediglich durch schriftlich formulierte Dokumente oder Mitteilungen geändert werden, die von den gesetzlichen Vertretern der Vertragspartner unterzeichnet sind; alle schriftlichen Mitteilungen entsprechend den vorliegenden allgemeinen Lieferbedingungen werden per fax oder Einschreiben mit Rückantwortquittung zugestellt.
- Fuer Ruecklieferung wo der Fa. Emilceramica nicht Schuld ist wird an der Kunde 15% des Gesamte Betrag in Rechnung gestellt.

EMILCERAMICA

CONDICIONES GENERALES DE VENTA Y GARANTIAS

EN GENERAL

- Las presentes condiciones forman parte de todos los contratos de venta en los que interviene Emilceramica
- Excluso en algunos casos, en los que se derogasen, con acuerdos expresamente escritos y firmados por Emilceramica (en bajo denominada VENDEDOR) estas constituyen la disciplina exclusiva de tales ventas.
- Si una o más partes de las presentes condiciones o de los contratos individuales que las incluyan resultasen nulas, las condiciones generales o particulares quedarán vigentes en su conjunto; las partes no válidas serán reemplazadas con acuerdos lo más fieles posible a la voluntad original de las partes.
- Toda oferta, toda aceptación de un pedido y cualquier su ministro del Vendedor, se considera hecho dentro de las presentes Condiciones, salvo expresa deroga escrita suscrita por el Vendedor, la aceptación de dichas ofertas y la recepción de Productos provenientes del Vendedor implica, por lo tanto, la aceptación del comprador de las presentes Condiciones con los acuerdos escritos que existieren entre las partes.
- La venta se considera cerrada en el momento en que el oferente o el ordenante toman, personalmente, conocimiento del consentimiento de la contraparte. Si tal consentimiento no ha sido dado por escrito, serán válidas únicamente las comunicaciones escritas de notificación de mercancía lista o, en su defecto, de la expedición de la mercancía al ordenante, o en fin, la consaña de los productos al mandante o al trasportador.
- La Orden de Compra que no se confirme por escrito, en ningún caso se considerará aceptada, salvo que el Vendedor efective la misma con la comunicación escrita de la mercancía lista, con la expedición o con la entrega de los Productos.
- La entrega parcial de los productos pedidos no implica la aceptación de todo el pedido, sino únicamente de esa parte efectivamente entregada.
- Toda oferta del Vendedor se considera libre y sin compromisos; si se acuerda por escrito, la misma será válida por 14 días a partir de su envío.
- Queda convencionalmente establecido que la efectivización del contrato de venta se hará en la sede del Vendedor.

ORDENES DE COMPRA / ENTREGAS

- Se considera efectuada la entrega hecha en n/planta de Fiorano Modenese. La mercancía viaja siempre por cuenta y riesgo del comprador, aún si se envía libre de porte. También son a cargo del comprador los riesgos de eventuales roturas y/o daños o deterioramientos.
- La entrega de los Productos se hará según la fórmula "Franco fábrica vendedor"; ésta y las otras fórmulas de entrega que se pactasen por escrito, en su alternativa, respetarán los "Incoterms" 1953 de la Cámara de Com. Internacional de París, en vigor al momento de la venta
- Si el Vendedor y el comprador acuerdan por escrito que la entrega de los Productos se hará "F.O.B puerto italiano", implica que la elección del puerto italiano de salida y de la navea la gestiona el Vendedor el cual actuará por cuenta del comprador.
- Los plazos de entrega son solo indicativos y no comprometerentes. Los atrasos de cualquier índole, no le dan al comprador el derecho de anular pedidos o de pretender indemnización por daños directos o indirectos. El Vendedor se reserva el derecho de poder efectuar entregas parciales de los pedidos .
- En caso de atraso de las entregas, el comprador podrá tras denunciar la mora, rehusar otras entregas y anular del contrato la parte de los Productos todavía sin entregar. La anulación del contrato de la parte de mercancía sin entregar a causa de atrasos, da lugar al pago, sólo, de aquellos Productos efectivamente entregados, excluido cualquier reembolso o indemnización.
- Las mercancías que el comitente pide por error o en excedencia, como así también las existencias en sus almacenes, no serán retiradas por nuestra empresa.
- Tamaños, pesos y características indicados en nuestras listas son meramente indicativos.
- Embalaje sobre Europalet con cobro.

CASOS DE FUERZA MAYOR

- El Vendedor no es responsable ante el comprador por cualquier incumplimiento, incluso la falta o el atraso de la entrega, a causa de hechos que escapan a su control como (indicativamente), la falta o el atraso de la entrega de los materiales de elaboración, por parte de los proveedores, desperfectos en las instalaciones, paros y otras acciones sindicales, interrupción de energía, suspensión o dificultades en los transportes.
- Para servirse de ésta clausula el Vendedor deberá comunicar al comprador el surgimiento de la causa de fuerza mayor, a más tardar a los 15 días de su verificación o de su conocimiento. Transcurridos 45 días desde la fecha prevista para la entrega, sin haber recibido al menos el 75% en valor, del pedido, el comprador podrá declarar, con comunicación escrita, el anulamiento de las entregas pendientes, consiguiendo el reembolso de los anticipos que hubiere efectuado.

PAGOS/PRECIOS

- Los pagos de las mercancías se efectuarán a nuestra sede de Fiorano Modenese. La emisión de letras de cambio o la aceptación de efectos pagaderos en otras plazas no implican deroga a esta cláusula.

En caso de atraso del pago total o parcial de una factura, el Vendedor, salvo sus otros derechos, tiene la facultad de suspender las sucesivas entregas, aún si dependen de otros contratos, de emitir letra de cambio por el monto total de las facturas vencidas y, asimismo, de reclamar el pago inmediato y por entero de todo el material solicitado o de tenerlo de otra manera garantizado.

En caso de retraso en los pagos, el Vendedor, tendrá derecho de postergar sus entregas por un plazo igual al atraso de los pagos, cualquier sea el importe y hasta el saldo de dichos pagos con los intereses correspondientes a la mora.

En los retrasos de los pagos, sin perjuicio de otras acciones, los intereses corren en un 5% (cinco por ciento) más de la tasa oficial de descuento, a partir de la fecha de vencimiento de cada factura en cualquier caso dentro de los limites de la leg. 07/03/96 11.108 y eventuales modifcas.

- Para la facturación rigen los precios de lista vigentes al día de la entrega. En el caso de una modificación de los precios entre la confirmación del pedido y el día del suministro tenemos el derecho de adegular los precios pactados, de acuerdo con la nueva situación.

GARANTÍA

- Las ilustraciones y las descripciones de los catálogos y de las listas de precios, todas nuestras publicaciones y muestrarios no se deben considerar vinculantes, puesto que su valor es simplemente indicativo.

El tamaño de los productos sujetos a calibre y, en especial, de los pavimentos gres de porcelánico, se deben considerar con las tolerancias de uso.

Las diferencias de tono y las repetidas imperfecciones de los decorados son unas características fundamentales para reproducir una producción artística.

Como n/materiales están sometidos a una cocción de alta temperatura, no se pueden garantizar las reproducciones exactas de los colores. Es normal un esparcimiento en las tonalidades del color.

La garantía de la mercadería está limitada al material de 1° calidad exclusivamente. Nuestra responsabilidad queda expresamente excluida en caso de materiales de 2° y 3° calidad o de stock, así como en caso de partidas ocasionales y/o especiales que se consideran vendidas como material "visto y apreciado" sin garantía alguna.

Los materiales de 1° calidad están garantizados de acuerdo con lo establecido por las Normas ISO vigentes en el momento de la venta; para todos los aspectos no expresamente mencionados en esta garantía, el material se suministra fabricado con esmero y con arreglo a las costumbres habitualmente en uso en el sector cerámico según los consejos de empleo indicados en nuestro catálogo general.

La condición indispensable para la validez y la eficacia de la garantía es el respeto de las normas DIN 18352 y de las líneas guía ISO/TC 189 WG 6 CEN TR 13548:2004; DIN 18202; DIN 18352; ANSI A108, A118, A136 vers. 2011.1 para la colocación del material cerámico.

Eventuales reclamaciones, por vicios y defectos de la mercadería, se deberán presentar, so pena de caducidad, por escrito y enviar por carta certificada exclusivamente a la sede administrativa de Emilceramica situada en Fiorano Modenese dentro del plazo de vencimiento, correspondiente a ocho días a partir de la fecha de entrega del material en caso de defectos evidentes o de vicios ocultos de la mercadería. De no ser así, el comprador incurrirá en la caducidad del derecho a la garantía según lo establecido en el art. 1495 del C.C.

RECLAMOS

- Eventuales diferencias de tono no se deberán considerar un defecto del material y no se podrán denunciar como si de defecto se trataa.

En caso de que la reclamación sea enviada dentro del plazo establecido por la ley y resulte fundada, la obligación del vendedor estará limitada a la aceptación del material devuelto y a la consiguiente sustitución de la mercadería defectuosa enviándola al mismo lugar del primer suministro, por lo que el comprador renuncia expresamente a la resolución del contrato comprometiéndose de forma perentoria a no exigir reducción de precio o indemnización alguna.

La responsabilidad y la garantía no se extienden de forma alguna a los materiales ya colocados.

El material objeto de reclamación no será reemplazado en caso de que el comprador no interrumpa inmediatamente el uso del mismo al descubrir la presencia de eventuales defectos.

De todas formas, la garantía máxima no podrá superar un valor equivalente a cinco veces el valor del material reclamado con un techo máximo absoluto de e 10000,00 (diez mil euros).

- a) Los reclamos por falta de mercancía, deben efectuarse en el momento de la recepción.
b) Asimismo, al momento de la recepción, se han de comunicar los posibles reclamos por mercancía que no corresponde con lo establecido.
c) De todos modos, el comitente debe aceptar la entrega de la mercancía llegada. El material reclamado y/o el que se devolverá, ha de almacenarse con cuidado y al reparo de posibles daños.
d) La garantía por defectos no visibles queda sin valor o se limita en los siguientes casos: remoción no autorizada, colocación imperfecta del material, violación de nuestras indicaciones y directivas especiales tendientes a evitar y contener los daños. El empleo de materiales visiblemente fallados o deformes, implica la aceptación de sus características de calidad y excluye cualquier reclamo futuro.
e) La mercancía que suministramos será sustituida gratuitamente si se comprueba en ella la falta de las características garantizadas, resultando inutilizable. Se podrá acordar también, en alternativa, una reducción de su precio.

f) Para cualquier indemnización es obligatoria la comprobación de que la mercancía ha sido tratada adecuadamente y su colocación se hecho de manera perfecta. Ante la duda se solicitará una pericia técnica. Ante la comprobación del dano y cuando nuestra firma deba pagar la indemnización, los gastos de dicha pericia corren por nuestra cuenta.

g) Es imprescindible darnos la posibilidad de controlar los defectos reclamados, en su estado original, para poder constatar la causa del daño, se nos deberá conceder un plazo suficiente de tiempo. Si este derecho fuere denegado por el comprador, declinamos toda responsabilidad de indemnización.

h) El perjudicado tiene la obligación de tomar todas las medidas necesarias para limitar al mínimo los daños. Debe asegurarse, asimismo, un número suficiente de muestras del producto reclamado.

- Los reclamos de defectos encontrados en las piezas de un envío, no invalidan el mismo, solo se limitan a aquellas piezas falladas.

- El vendedor no está obligado a resarcir daños directos o indirectos, de cualquier tipo, al comprador, ocasionados por el empleo o falta de empleo del material defectuoso.

- Cualquier reclamo o disputa no implica la suspensión o el deniego al pago de las facturas, lo que deberá efectuarse regular y totalmente en los plazos convenidos;

DERECHO APLICABLE, FORO COMPETENTE, COMUNICACIONES ESCRITAS

- Los contratos de venta a la exportación, en los que participa el Vendedor, se regirán por la ley italiana y en especial por la ley uniforme sobre venta internacional de cosas muebles materiales y por la ley uniforme sobre la estipulación de contratos de venta internacional de cosas muebles materiales que no se deroguen por las presentes condiciones generales.

- El foro competente en todas las controversias relacionadas con las ventas de productos del Vendedor y con las relaciones afines a tales ventas, es el exclusivamente de la sede del Vendedor.

- Los contratos de venta reglamentados por las presentes condiciones generales, pueden modificarse únicamente mediante un documento o notificación escrita, firmados por los representantes legales de las partes. Toda comunicación escrita que se haga, conforme a las presentes condiciones generales, se enviará por fax o carta certificada con aviso de retorno.

- En caso de devoluciones de mercancía, que no ha sido causada por falta del delegado de zona, será añadida una penal del 15% del total valor.

ОБЩИЕ УСЛОВИЯ ПРОДАЖИ И ГАРАНТИИ

ОБЩИЕ СВЕДЕИЯ

- Данные общие условия являются неотъемлемой частью всех контрактов на продажу,заключенных с компанией Emilceramica.

- Исключая отдельные случаи, в которых условия были изменены письменными договорённостями, подписанными (именуемое в дальнейшем Продавцом), данные условия являются единственными, регулирующими эти продажи.

- Если одна или несколько частей данных условий или отдельных контрактов, включающих в себя условия, являются недействительными, обще или специальные условия являются действительными в целом.; Ннедействительные части будут заменены такими договоренностями, которые как можно больше приближаются к первоначальной воле сторон.

- Любое предложение, любое принятие заказа и любая поставка со стороны ПРОДАВЦА подразумевает сделанной на данных УСЛОВИЯХ, кроме исключений, подписанных ПРОДАВЦОМ.; Ппринятие данных предложений и получение ПРОДУКЦИИ, поступившей от ПРОДАВЦА, является принятием покупателями данных УСЛОВИИ, которые огут быть дополнены письменными договоренностями между сторонами.

- Продажа считается завершенной в тот момент, когда предлагающая или заказывающая сторона лично убеждаются в согласии противоположной стороны; в случае, если это согласие не было выражено в письменной форме, то письменным сообщением о согласии являются лишь только письменные сообщения о готовности товара или же в случае их отсутствия уведомление об отправке товара заказчику или же, наконец, известность о первой поставке ПРОДУКЦИИ заказчику и/или его перевозчику.

- Заказ, не подтвержденный в письменной форме, ни в коем случае не может считаться принятым, кроме случая его выполнения ПРОДАВЦОМ посредством сообщения о готовности товара, об отправке или же посредством поставки ПРОДУКЦИИ.

- Частичная поставка заказанной продукции не является фактом принятия всего заказа, а лишь только части, касающуюся реально поставленной продукции.

- Подразумевается, что любое предложение ПРОДАВЦА является свободным и необязывающим; если оно поступило в письменной форме, то оно считается действительным в течение 14 дней с момента его отправки.

- В любом случае считается, что исполнение контракта на продажу выполняется по месту нахождения ПРОДАВЦА.

ЗАКАЗЫ/ПОСТАВКИ

- Подразумевается, что поставка выполняется на нашем предприятии в г. Fiorano Моденезе. Товар всегда перевозится под ответственностью покупателя, даже при отправке на условиях франко порт. Таким образом, на покупателя возлагается также и риск за возможный бой и/или полоумю или же порчу.

- Поставка ПРОДУКЦИИ ВЫПОЛНЯЕТСЯ ПО ФОРМУЛЕ "Франко предприятие продавца"; эта формула, как и альтернативные формулы поставки, которые могут быть оговорены в письменной форме, основываются на правилах "Incoterns" от 1953 года Парижской Международной торговой палаты в издании, действующем на момент продажи.

- В случае, если ПРОДАВЕЦ и покупатель договариваются в письменной форме о том, что поставка ПРОДУКЦИИ осуществляется на условиях "FOB итальянский порт", то подразумевается, что выбор судна и итальянского порта отправки будет сделан ПРОДАВЦОМ, который будет действовать за счет покупателя.

- Сроки поставки являются лишь только приблизительными и необязательными. Возможные задержки, вызванные любыми причинами, никогда не дают покупателю право на отмену заказа или на претензии по возмещению прямого или косвенного ущерба. ПРОДАВЕЦ недумысленно оставляет за собой право на выполнение частичных поставок по каждому заказу.

- В случае задержек в поставке, после обычного начала исчисления штрафа покупатель может отказаться от последующих поставок и расторгнуть контракт на еще не поставленную часть ПРОДУКЦИИ. Расторжение контракта на еще не поставленную часть по причине задержки приводит к оплате лишь только реально поставленной ПРОДУКЦИИ, исключая какое-либо возмещение ущерба.

- Товар, заказанный покупателем по ошибке или же заказанный с излишком, а также остатки, не могут быть возвращены нашей компании.

- Указанные в наших прайс-листах размеры, вес и характеристики должны считаться приблизительными.

- Упаковка на европоддонах за счет заказчика.

ФОРС-МАЖОР

- ПРОДАВЕЦ не несет ответственность перед покупателем за любое невыполнение, включая невыполнение или задержку поставки, вызванную неподконтрольными ему событиями, такими как, например: невыполнение или задержка поставки сырья поставщиками, неисправности систем, забастовки или другие действия профсоюзов, прекращение подачи энергоносителей, прекращение или сложности с транспортными услугами.
- Чтобы воспользоваться данным положением, ПРОДАВЕЦ должен сообщить о возникновении форс-мажорных обстоятельств покупателю не позднее 15 дней после их возникновения или принятия к сведению. После истечения 45 дней с предусмотренной даты поставки и не получив товара хотя бы на 75% от суммы заказа, покупатель можетзаявить в письменной форме об откaze от будущих поставок с последующим возвратом лишь только уплаченных авансовых сумм.

ОПЛАТА/ЦЕНЫ

- Оплата товара должна выполняться лишь только по нашему адресу в г. Fiorano Моденезе. Выдача тратт или принятие векселей, оплачиваемых в других местах, не являются отклонением от данного положения. В случае полной или же частичной задержки оплаты по инвойсу продавец, сохраняя все остальные свои права, будет иметь право на прекращение последующих поставок, даже если они входят в другие контракты, на выдачу тратты на сумму истекших инвойсов, а также претендовать на немедленную и полную оплату всего заказанного материала или же на гарантии иного типа.

В случае задержки оплаты ПРОДАВЕЦ будет иметь право на отсрочку поставок на срок, равный задержке оплаты, вне зависимости от суммы, вплоть до осуществления данной оплаты и соответствующих штрафных процентов.

В любом случае, по задержанным оплатам, не отказываясь от любых других действий, будет начисляться штраф в размере 5% (пять процентов) сверх официальной банковской учетной ставки, начиная с даты просрочки оплаты каждого отдельного инвойса, в любом случае, в пределах соответствующего Закона 07/03/96 11.108 и любых последующих поправок.

- При взаиморасчетах действительные цены прайс-листа, действующего в день поставки. В случае изменения цен в период между подтверждением заказа и днем поставки мы имеем право на адаптацию установленных цен к новой ситуации.

ГАРАНТИЯ

- Иллюстрации и описания каталогов и прайс-листов , все наши публикации и образцы не являются обязывающими, а чисто ориентировочного характера. Размеры продукции, подлежащие калибровке , в особенности керамогранитовых половых покрытий, являются с допустимыми отклонениями.

- Различия тона и неестественные несовершенства декоров являются положительной характеристикой художественного производства.

- Наш материал обжигается при высокой температуре, следовательно, не гарантируется точное воспроизведение цветов. Разница тонов цвета является нормальным явлением.
- Гарантия товаров ограничивается только материала 1-ого сорта . Поэтому наша ответственность исключена для материалов 2-го и 3-го сорта или складского запаса и для случайных партий и/или специальных, которые подразумеваются проданные как "увидел и полюбил", без каких-либо гарантий.

Гарантируется, что материалы 1 сорта соответствуют нормам UNI-EN ISO, действующим на момент продажи.; и касательно того, что в них не оговаривается специально, д еляется продаются со ссылкой на отраслевые правила и обычно используемые положения в керамической промышленности и советов по использованию приведенных в нашем общем каталоге.
Необходимое условие для применения гарантии - это соблюдение норм по укладке DIN 18352 и европейский инструкций ISO/TC 189 WG 6 CEN TR 13548:2004; DIN 18202; DIN 18352; ANSI A108, A118, A136 версия 2011.1.

Любые претензии на дефекты и недостатки товара должны быть сообщены, в условиях срока, в письменной форме заказым письмом для доставки только в администрацию Emilceramica в Fiorano Моденезе в пределах срока восьми дней от доставки материала, для выявления очевидных дефектов, и обнаружению каких-либо окультных дефектов. При отсутствии вышеперечисленного, покупатель теряет право на гарантию в соответствии со статьей 1495 C.C.

СПОРЫ

- Любые различия в тоне не являются дефектом материала и не могут быть заявлены как таковыми. Если претензия является своевременной и обоснованной, обязательство продавца ограничивается принятием взамен и, как следствие, замена дефектного товара или неисправленного на фактическом месте первоначальной поставки, тем самым абсолютно исключая договорённость, как любое снижение цены или возмещение ущерба. Ответственность и гарантия не распространяются в любом случае на материалы уже на рабочем месте. Замена оспариваемого материала, не будет на месте, где покупатель немедленно не приостановил использование в момент обнаружения. В любом случае максимальная гарантия не может превышать значение, соответствующее пять раз превышает стоимость оспаривается материал с абсолютным максимумом и 10000 (десять тысяч).

- a)Претензии по недостающему товару должны выставляться в момент получения.

b) Кроме того, в момент получения товара должны выставляться претензии по поставленному товару, отличающемуся от достигнутых договорённостей.

v) В любом случае, поставка отправленного товара должна быть принята заказчиком. Поставки оспариваемых материалов и/или возвращаемый материал должны храниться покупателем должным образом, в защищенном от возможной порчи месте .

g) Гарантия на скрытые дефекты исключается или же ограничивается в случае: неразрешенного удаления работ, укладки, выполненной с нарушением норм, несоблюдения наших предписаний и специальных указаний по применению, фактов повреждения, вызванных неприлжеанием, которые привели к увеличению объема ущерба. Использование товара с видимыми дефектами или же несоответствующего заказанному является принятием характеристик качества и исключает любые другие претензии.

d) Поставленный нами товар заменяется бесплатно, если не соблюдаются гарантированные характеристики и, следовательно, товар является неиспользуемым. Вместо замены может быть достигнута договоренность об уменьшении цены.

e) По каждому возмещению ущерба является обязательным предоставление подтверждения, что с товаром обращались должным образом, и что он был уложен с соблюдением правил. В случае сомнений требуется проведение технической экспертизы. В случае подтверждения ущерба, и если наша компания должна произвести возмещение, расходы на проведение данной экспертизы возлагаются на нас.

ж) Нам должна быть предоставлена возможность роверить оспариваемые дефекты в их первоначальном состоянии. В этом случае должно быть предоставлено достаточно времени для констатации причины ущерба. Если в этом праве будет отказано покупателем, то мы не несем никакой ответственности по возмещению ущерба.

з) Понесшая ущерб сторона обязуется предпринять все необходимые меры для сведения ущерба до минимума. Кроме того, она должна предоставить как можно большее число образцов оспариваемого товара.

28) Рекламация на дефекты, обнаруженные в поставленных деталях, не отменяет поставку и распространяется лишь на изделия, являющиеся дефектными.

29) Продавец не обязан возмещать покупателю прямой или косвенный ущерб любого характера, вытекающий из использования или неиспользования дефектного материала.

30) Любая рекламация или протест не является поводом к прекращению или отказу оплаты по инвойсам, которая должна выполняться полностью и в установленные в договоренностях сроки.

ПРИМЕНЯЕМОЕ ПРАВО, КОМПЕТЕНТНЫЙ СУД, ПЕРЕПИСКА

1) Контракты на экспортную поставку, в которых участвует ПРОДАВЕЦ, регулируются итальянским законодательством, в частности, единым законом о международных поставках движимого материального имущества, а также единым законом о составлении контрактов на международную продажу движимого материального имущества, если они не нарушаются данными общими условиями.

32) Компетентным судом по всем спорам, касающимся продаж ПРОДУКЦИИ ПРОДАВЦОМ, и отношений, связанных с данными продажами, является суд по месту нахождения ПРОДАВЦА.

33) Контракты на продажу, регулирующиеся данными общими условиями, могут быть изменены только путем документа, составленного в письменной форме, подписанного легальными представителями сторон. Любое письменное сообщение, составленное в соответствии с сданными общими условиями, будет направляться по телексу или заказным письмом с уведомлением о вручении.

34) В случае запроса на возврат товара не по вине ПРОДАВЦА будет налагаться штраф в размере 15% от стоимости возвращаемого товара.

EMILCERAMICA

EMIL CERAMICA

COORDINAMENTO

Ufficio Marketing Emilceramica Group

COPYRIGHT © EMILCERAMICA
FEBBRAIO 2020

 17 DoP - F
Emilceramica S.r.l. a socio unico Via Ghiarola Nuova, 29 41042 Fiorano Modenese (MO) - Italia Tel. +39 0536 835 111
EN 14411
Dry-pressed ceramic tiles, with water absorption $E_w \leq 0,5\%$. for internal and external walls and floorings

I colori e le caratteristiche estetiche dei materiali illustrati nel presente catalogo sono da ritenersi puramente indicativi. Le misure dei prodotti qui indicate si intendono nominali e come i pesi ed i colori subiscono le variazioni tipiche del processo ceramico. Emilceramica si riserva la facoltà di modificare in qualunque momento senza preavviso le caratteristiche tecniche, estetiche e i materiali presentati. Tali caratteristiche non sono comunque vincolanti nei termini legali.

Colours and optical features of the materials illustrated in this catalogue are to be regarded as mere indications. Product sizes indicated are nominal and like weights and colours undergo the typical variations of the ceramic process. Emilceramica reserves the right to change the technical and optical features of the materials illustrated at any time and without notice. These features are not legally binding.

Les coloris et les caractéristiques esthétiques des références illustrées dans le catalogue sont donnés à titre purement indicatif. Les caractéristiques indiquées concernant les dimensions des articles, sont à considérer nominale tout comme le poids et les coloris elles peuvent subir des variations dues au procédé céramique. La Société Emilceramica se réserve le droit de modifier à tout moment et sans aucun préavis les caractéristiques techniques et esthétiques des produits présentés dans son catalogue. Ces modifications ne pourront pas entraîner de procédures légales.

Die Farben und die ästhetischen Eigenschaften der in diesem Katalog abgebildeten Produkte sind als reine Richtwerte zu betrachten. Die hier angegebenen Abmessungen verstehen sich als Sollwerte und sind (wie Gewicht und Farbe) den typischen Änderungen des Keramikprozesses ausgesetzt. Emilceramica behält sich das Recht vor die technischen und ästhetischen Eigenschaften der vorgestellten Produkte jederzeit ohne Voranzeige zu ändern. Obengenannte Eigenschaften sind jedoch rechtmäßig nicht verblindlich.

Los colores y las características de los materiales ilustrados en el presente catálogo son para retenerse solo indicativamente. Las medidas de los productos aquí indicados se entienden nominalmente y como el peso y los colores sometidos a las variaciones típicas del procedimiento cerámico. Emilceramica se reserva la facultad de modificar en cualquier momento sin preaviso las características técnicas, estéticas y los materiales presentados. Tales características no son vinculantes en términos legales.

Цвета и внешние характеристики материала, представленного в каталоге, должны расцениваться как приблизительные. Указанные размеры продукции являются номинальными, и, также как и вес и цвета, подвергаются типичным для керамического процесса изменениям. Emilceramica оставляет за собой право изменять в любой момент без какого-либо предупреждения представленные технические и внешние характеристики и материалы. Данные характеристики не влекут за собой ответственности для продавца с юридической точки зрения.



Emilceramica is a brand of Emilceramica S.r.l. a socio unico	Sede Commerciale/ Amministrativa
emilgroup.it/emilceramica emilgroup.it	Via Ghiarola Nuova, 29 - 41042 Fiorano Modenese (Mo) Italy T +39 0536 835111 - info@emilceramicagroup.it