

/21

EMIL
CERAMICA

INDICE ALFABETICO

Alphabetical index
Index alphabétique
Alphabetischen index
Índice alfabético
Алфавитный указатель

20Twenty	38
Anthology Stone *	42
Be-Square	48
Chateau *	58
Dimore	64
Eterna	68
Externa *	74
Externa Cotto *	78
Externa Quarzite *	82
Kotto *	86
Landscape (St) SILKtech	94
Millelegni	102
Millelegni Remake *	108
Nordika	114
On Square	120
Petra	128
Piase *	134
Sleek Wood	140
Stone Box	144
Tele di Marmo	148
Tele di Marmo Reloaded	162
Tele di Marmo Revolution	176
Tele di Marmo Selection	184
Totalook	194
Tracce	204

*** R11 disponibile per questa collezione.**

R11 available for this collection.
R11 disponible pour cette collection.
R11 für diese Kollektion erhältlich.
R11 disponible para esta colección.
R11 доступен для этой коллекции.

INDICE PER PREZZO

Price band Gamme de prix Preisgruppe Franja de precio Код ценового сегмента
● Prezzo al Mq Price per Sqm Prix au m² Preis pro Qm Precio por Mc Цена за кв.м.
● Prezzo al Pezzo Price per piece Prix à l’unité Preis pro Stück Precio por pieza Цена за штуку

Shield: Processo Antibatterico	
Shield: Antimicrobial Process	
Shield : Processus Antimicrobien	
Shield: Antimikrobielle Technologie	
Shield: El Proceso Antimicrobiano	
Shield: Антимикробный Процесс	6

Sistema Gestione Integrato	
Integrated Management System	
Système de gestion intégré	
Integriertes Management system	
Sistema de gestión integrado	
Интегрированная система менеджмента	14

Applicazioni Tecniche
Technical Applications
Applications Techniques
Technische Anwendungsbereiche
Aplicaciones Técnicas
Технические Применения

Pave & Go	214
-----------	------------

Facciate ventilate	
Ventilated Facade	
Façade Ventilée	
Vorgehängte Hinterlüftete Fassade	
Fachada Ventilada	
Вентилируемый Фасад	228

Pavimenti sopraelevati	
Cavity Floors	
Planchers Surélevés	
Doppelböden	
Pavimentos Sobreelevados	
Фальшполы	238

Sezione tecnica	
Technical information	
Section technique	
Technische Angaben	
Seccion técnica	
Технический раздел	248

INDICE PER FORMATO

Index by format
Index selon le format
Index nach format
Índice por formato
Индекс по формату

120x278 ↕ 6,5 mm.	
Be-Square	48
Tele di Marmo	148
Tele di Marmo Reloaded	162
Tele di Marmo Revolution	176
Tele di Marmo Selection	184
120x240 ↕ 6,5 mm.	
Be-Square	48
Tele di Marmo	148
Tele di Marmo Reloaded	162
120x120 ↕ 6,5 mm.	
Be-Square	48
Tele di Marmo	148
Tele di Marmo Reloaded	162
Tele di Marmo Revolution	176
Totalook	194
60x120 ↕ 6,5 mm.	
Be-Square	48
Totalook	194

90x180 ↕ 10,5 mm.	
Tele di Marmo	148
Tele di Marmo Reloaded	162
Tele di Marmo Revolution	176
Tele di Marmo Selection	184
22,5x180 ↕ 10,5 mm.	
20Twenty	38

120x120	
Chateau	58
25x150	
20Twenty	38
Millelegni Remake	108
60x120	
Be-Square	48
Chateau	58
Eterna	68
Landscape	94
Nordika	114
On Square	120
Piase	134
Tele di Marmo	148
Tele di Marmo Reloaded	162
Tele di Marmo Revolution	176
Tele di Marmo Selection	184

30x120	
Millelegni	102
20x120	
20Twenty	38
Dimore	64
Millelegni	102
Millelegni Remake *	108
15x120	
Millelegni	102
90x90	
Nordika	114
Tele di Marmo	148
Tele di Marmo Reloaded	162
Tele di Marmo Revolution	176
Tele di Marmo Selection	184
45x90	
Nordika	114
On Square	120
Piase	134
Stone Box	144
15x90	
Sleek Wood	140
Stone Box	144
80x80	
Be-Square	48
Chateau	58
Kotto	86
Landscape	94
On Square	120
Petra	128
Totalook	194
40x80	
Be-Square	48
Chateau	58
Kotto	86
Landscape	94
Totalook	194
20x80	
Petra	128

60x60	
Be-Square	48
Chateau *	58
Eterna	68
Kotto *	86
Landscape	94
Nordika	114
On Square	120
Petra	128
Piase *	134
Totalook	194
Tracce	204

30x60	
Anthology Stone *	42
Be-Square	48
Chateau	58
Eterna	68
Kotto	86
Landscape	94
Nordika	114
On Square	120
Petra	128
Piase *	134
Tele di Marmo	148
Tele di Marmo Reloaded	162
Tele di Marmo Revolution	176
Tele di Marmo Selection	184
Totalook	194
Tracce	204
7,5x30	
Eterna	68
Tele di Marmo	148
Tele di Marmo Reloaded	162
20x40	
Externa *	74
Externa Cotto *	78
Externa Quarzite *	82
20x20	
20Twenty	38
Be-Square	48

11x54 (Chevron)	
Sleek Wood	140
Brick 6x24	
Totalook	194
Opus (20x20-20x30)	
Landscape	94

Brick 12,5x25 ↕ 9 mm.	
Kotto *	86
Brick 6x25 ↕ 9 mm.	
Kotto *	86

50x100 20MM R11	
Nordika	114
40x120 20MM R11	
Millelegni	102
Millelegni Remake	108
45x90 20MM R11	
On Square	120
80x80 20MM R11	
Be-Square	48
Chateau	58
Landscape	94
Totalook	194
60x60 20MM R11	
Be-Square	48
Chateau	58
Landscape	94
Totalook	194

DAL 1961 ECCELLENZA E INNOVAZIONE NELLA CERAMICA.

Dal 1961 siamo tra i leader mondiali nel settore della ceramica. Con passione e visione ideiamo, produciamo e distribuiamo in tutti i continenti materiali in gres porcellanato di qualità superlativa per 4 brand - Emilceramica, Ergon, Provenza e Viva - perpetuando e rinnovando il meglio del Made in Italy. Curiamo fin nei minimi dettagli anche le fasi di assistenza e post vendita, certi che perseguire l'eccellenza e l'innovazione in ogni singolo aspetto del nostro lavoro sia la strada maestra per soddisfare appieno i nostri clienti e rafforzare quella reputazione di partner solido, reattivo e affidabile che resta il nostro più prezioso capitale.



EXCELLENCE AND INNOVATION IN CERAMIC COVERINGS SINCE 1961

We have been a world leader in ceramic coverings since 1961. With passion and vision, we design, produce and globally distribute superlative quality porcelain stoneware materials for 4 brands - Emilceramica, Ergon, Provenza and Viva - perpetuating and renewing the best of Italian style and manufacturing.

We also take care of technical service and after-sales down to the tiniest detail, in the firm belief that pursuing excellence and innovation in every single aspect of what we do is the secret to fully satisfying our customers, and reinforcing our reputation as a sound, responsive, reliable partner: our most valuable asset.

DEPUIS 1961, EXCELLENCE ET INNOVATION EN CÉRAMIQUE

Depuis 1961, nous sommes parmi les chefs de file mondiaux dans le secteur de la céramique. Nous fabriquons et distribuons, avec passion et avec clairvoyance, sur tous les continents, un grès cérame de première qualité sous 4 marques - Emilceramica, Ergon, Provenza et Viva - en perpétuant et en modernisant le meilleur du Made in Italy.

Nous apportons aussi une très grande attention à l'assistance et à l'après-vente, parce que nous sommes d'avis que la poursuite de l'excellence et de l'innovation, à toutes les étapes de notre travail, est la seule et unique voie pour satisfaire totalement nos clients et pour consolider notre réputation de partenaire sérieux, réactif et fiable qui reste notre atout le plus précieux.

QUALITÄT UND INNOVATION IN DER KERAMIK SEIT 1961

Wir sind seit 1961 weltweit führend im Bereich Keramik. Mit Leidenschaft und visionären Ideen entwickeln und produzieren wir besonders hochwertige Feinsteinzeugmaterialien, die wir unter den 4 Markennamen Emilceramica, Ergon, Provenza e Viva in allen Kontinenten vertreiben - bestes Know-how Made in Italy.

Unser besonderes Augenmerk gilt auch dem After-Sales-Service. Wir sind davon überzeugt, dass Qualität und Innovation in jedem Detail der beste Weg ist, um die Zufriedenheit unserer Kunden zu erreichen und unseren Ruf als solider, zuverlässiger und reaktionsschneller Partner zu stärken: Dies ist und bleibt unser wertvollstes Kapital.

DESDE 1961 EXCELENCIA E INNOVACIÓN EN LA CERÁMICA

Desde 1961 estamos entre las empresas punteras del mundo entero en el sector de la cerámica. Con entusiasmo y visión de futuro ideamos, producimos y distribuimos a todos los continentes materiales de gres porcelánico de calidad superlativa para cuatro marcas - Emilceramica, Ergon, Provenza y Viva -, perpetuando y actualizando lo mejor del Made in Italy. También cuidamos hasta el menor de los detalles los servicios de asistencia y posventa, con la seguridad de que perseguir la excelencia y la innovación en cada uno de los aspectos de nuestro trabajo es el único camino para satisfacer plenamente a nuestros clientes y reforzar la reputación de socio sólido, ágil y fiable que constituye nuestro capital más valioso.

СОВЕРШЕНСТВО И ИННОВАЦИИ В КЕРАМИКЕ С 1961 Г.

С 1961 года мы являемся мировыми лидерами в керамическом производстве. Увлеченно и дальновидно мы разрабатываем, производим и реализуем на всех континентах планеты нашу продукцию из керамогранита высочайшего качества 4 брендов: Emilceramica, Ergon, Provenza и Viva, развивая и обновляя лучшее из Made in Italy.

Мы самым тщательным образом отслеживаем также процессы поддержки и послепродажного обслуживания, веря в то, что стремление к совершенству и инновациям в каждой отдельной сфере нашей работы является верным путем к полному удовлетворению наших клиентов и к укреплению репутации надежного, динамичного и внушающего доверие партнера, что является нашим самым ценным достоянием.

EMIL CERAMICA

TILES FOR LIFE

Da oltre 50 anni, nel punto di equilibrio più avanzato tra tradizione e innovazione, lavoriamo come partner affidabile al servizio di milioni di famiglie e consumatori in tutto il mondo, aiutandoli a mettere a fuoco i loro bisogni nel campo dei materiali ceramici da rivestimento, per poi soddisfarli a 360°. Dalla selezione delle migliori materie prime all'ideazione di prodotti eccellenti; dall'offerta di una ricchissima gamma di collezioni a un servizio post vendita estremamente efficiente: tutto è parte di uno sforzo appassionato che mette sempre al centro le persone e la qualità degli spazi in cui vivono.

TILES FOR LIFE

We have been working for over 50 years in the forefront of innovation teamed with tradition, as a reliable partner serving millions of households and consumers worldwide, helping them to pinpoint their ceramic covering needs and then satisfying them in every single aspect.

From the selection of the best raw materials to the design of outstanding products; from the offering of an amazingly rich range of collections to an extremely efficient after-sales service: all this is embraced by a passionately fulfilled mission that always puts people and the quality of their living-spaces first.

TILES FOR LIFE

Depuis plus de 50 ans, nous témoignons d'un parfait équilibre entre tradition et innovation pour être un partenaire fiable au service de millions de familles et consommateurs dans le monde entier, en les aidant à identifier le meilleur matériel céramique pour les revêtements de mur, pour aboutir à leur satisfaction totale.

Sélection des meilleures matières premières, création de produits d'excellence, très grande variété de collections, service après-vente extrêmement efficace: tout s'inscrit dans une démarche passionnée qui gravite autour des personnes et autour de la qualité de leurs espaces de vie.

TILES FOR LIFE

Seit mehr als 50 Jahren stehen wir für die ideale Verbindung von Tradition und Innovation und sind ein zuverlässiger Partner für Millionen von Familien und Verbrauchern in der ganzen Welt, die wir zielgerichtet bei der Auswahl von Keramikbelägen unterstützen und deren Anforderungen wir rundum erfüllen.

Von der Auswahl der besten Rohstoffe für hochwertige Produkte über die Konzeption eines umfangreichen Angebots an Kollektionen bis zu unserem effizienten After-Sales-Service: Wir stellen stets den Menschen und die Qualität seiner Wohnräume in den Mittelpunkt unserer Arbeit.

TILES FOR LIFE

Desde hace más de cincuenta años, en el punto de equilibrio más avanzado entre la tradición y la innovación, trabajamos como socio fiable al servicio de millones de familias y consumidores del mundo entero, ayudándolos a detectar sus necesidades en el campo de los materiales cerámicos de revestimiento, para después satisfacerlos al cien por cien. Desde la selección de las mejores materias primas hasta la concepción de productos excelentes; de la oferta de una amplísima gama de colecciones a un servicio posventa extraordinariamente eficaz: todo forma parte de un esfuerzo entusiasta que se centra en las personas y en la calidad de los espacios en los que viven.

TILES FOR LIFE

Более 50 лет мастерски балансируя между традициями и инновацией, мы выступаем в качестве надежного партнера на службе миллионов семей и потребителей во всем мире, помогая им определить их потребности в области керамических облицовочных материалов и удовлетворяя их на 100%. От отбора наилучшего сырья до разработки совершенной продукции, от предложения богатой линейки коллекций до чрезвычайно эффективного послепродажного обслуживания - все это является результатом труда и увлеченности, всегда ставящих в центр внимания людей и качество пространства, в котором они живут.



SHIELD: IL PROCESSO ANTIBATTERICO CHE AIUTA A COMBATTERE LA CRESCITA BATTERICA PER UN ABITARE PIÙ PULITO E PIÙ IGIENICO.

La tecnologia a base d'argento aiuta a bloccare la proliferazione dei batteri e – a differenza dei normali detersivi chimici che perdono efficacia una volta che la superficie si sia asciugata – la tecnologia integrata di **Shield** resta attiva 24/7, contribuendo a ridurre il rischio di contaminazione batterica da una superficie all'altra.



Riduzione fino al
99,9%
nelle popolazioni di
Escherichia coli
e **Staphylococcus aureus**
sulle superfici
trattate

Protezione
24/7

SHIELD: ANTIMICROBIAL PROCESS THAT HELPS TO REDUCE BACTERIAL GROWTH FOR CLEANER MORE PLEASANT LIVING SPACES.

The silver based technology helps inhibit the proliferation of bacteria and - unlike standard cleaning chemicals, which lose efficacy once the treated surface dries - the built-in technology of Shield remains active 24/7, helping reduce the risk of bacterial cross-contamination from surface to surface.

Delivers up to 99,9% reduction in Escherichia coli and Staphylococcus aureus on treated surfaces. Protection 24/7.

SHIELD : LE PROCESSUS ANTIMICROBIEN QUI AIDE À RÉDUIRE LA CROISSANCE BACTÉRIENNE POUR UN HABITAT PLUS PROPRE ET PLUS AGRÉABLE À VIVRE.

Contrairement aux détergents chimiques normaux qui perdent leur efficacité une fois la surface séchée, la technologie à base d'argent aide à bloquer la prolifération des bactéries et la technologie intégrée de Shield reste active 24/7, contribuant ainsi à réduire le risque de contamination bactérienne croisée d'une surface à l'autre.

Réduction jusqu'à 99,9 % chez les populations de Escherichia coli et Staphylococcus aureus présentes sur les surfaces traitées.

Une protection 24 h/24, 7j/7.

SHIELD: DIE ANTIMIKROBIELLE TECHNOLOGIE HILFT GEGEN DAS BAKTERIENWACHSTUM UND SORGT FÜR EIN SAUBERES UND ANGENEHMES WOHNKLIMA.

Die Silberionen-Technologie hilft, die Vermehrung von Bakterien einzudämmen. Anders als normale chemische Reinigungsmittel, die nach dem Trocknen der Oberfläche ihre Wirkung verlieren, bleibt die eingearbeitete Technologie von Shield rund um die Uhr aktiv und trägt dazu bei, das Risiko einer bakteriellen Kreuzkontamination von Oberfläche zu Oberfläche zu reduzieren.

Reduzierung bis zu 99,9% der Populationen von Escherichia coli und Staphylococcus aureus auf den behandelten Flächenbelägen.

Schutz 24/7.

SHIELD: EL PROCESO ANTIMICROBIANO QUE AYUDA A REDUCIR LA PROLIFERACIÓN BACTERIANA PARA UNA VIVIENDA MÁS LIMPIA Y MÁS AGRADABLE.

La tecnología a base de plata ayuda a bloquear la proliferación de las bacterias y —a diferencia de los detergentes químicos corrientes que pierden eficacia una vez se ha secado la superficie— la tecnología integrada de Shield permanece activa 24/7, contribuyendo a reducir el riesgo de contaminación bacteriana cruzada de una superficie a la otra.

Reducción de hasta el 99,9% en las poblaciones de Escherichia coli y Staphylococcus aureus de las superficies tratadas.

Protección 24/7.

SHIELD: АНТИМИКРОБНЫЙ ПРОЦЕСС, ПОМОГАЮЩИЙ СНИЗИТЬ РАЗВИТИЕ БАКТЕРИЙ ДЛЯ СОЗДАНИЯ БОЛЕЕ ЧИСТОЙ И БОЛЕЕ ПРИЯТНОЙ СРЕДЫ ДЛЯ ПРОЖИВАНИЯ.

Интегрированная технология Shield на основе серебра помогает блокировать размножение бактерий и, в отличие от обычных химических моющих средств, теряющих эффективность после высыхания поверхности, она остается активной круглосуточно, способствуя снижению риска перекрестного бактериального заражения, переходящего с одной поверхности на другую.

Снижение до 99,9% популяции Escherichia coli и Staphylococcus aureus на обработанных поверхностях.

Круглосуточная защита.

PLUS

ELIMINA FINO AL 99,9%
DEI BATTERI SULLE SUPERFICI
TRATTATE

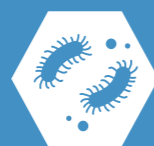

L'ingrediente attivo agli ioni d'argento aiuta a combattere la crescita batterica ostacolando la sopravvivenza, la riproduzione e la colonizzazione dei batteri sulle superfici trattate.

PULIZIA PIÙ PROFONDA
DELLE SUPERFICI



Grazie alla tecnologia antimicrobica integrata, Shield contribuisce a prevenire le macchie causate dalla crescita batterica e mantiene le superfici più pulite più a lungo.

AIUTA A ELIMINARE I CATTIVI
ODORI CAUSATI DALLA CRESCITA
BATTERICA



Contribuisce a prevenire la formazione di odori sgradevoli per un abitare più piacevole.

NESSUN IMPATTO NEGATIVO
SULL'ESTETICA DELLE
SUPERFICI CERAMICHE



L'integrazione della tecnologia a base di ioni d'argento nel processo ceramico non compromette in alcun modo l'estetica o la qualità dei nostri prodotti.

PLUS

ELIMINATES UP TO 99.9% OF BACTERIA ON THE TREATED SURFACE
The silver ion ingredient additive helps to combat bacteria growth by hindering their survival, reproduction and colonisation on the treated surface.

HIGHER LEVEL OF SURFACES CLEANLINESS
Thanks to its built-in antimicrobial properties, Shield helps prevent staining caused by bacterial growth and keeps surfaces cleaner for longer.

HELPS TO ELIMINATE UNPLEASANT SMELLS AND ODOURS CAUSED BY BACTERIAL GROWTH
It helps prevent the formation of undesirable smells for creating more pleasant living-spaces.

NO NEGATIVE IMPACTS ON AESTHETICS OF CERAMIC SURFACES
The inclusion of silver ion technology in the ceramic process has no negative effects on our products' looks or quality.

PLUSPUNKTE

BESEITIGT BIS ZU 99,9 % DER BAKTERIEN AUF DER BEHANDELTEN OBERFLÄCHE
Der aktive Inhaltsstoff auf Basis von Silberionen trägt zur Bekämpfung des Bakterienwachstums bei, indem er die Überlebensfähigkeit, die Reproduktion und den Befall der behandelten Oberfläche begrenzt.

GRÜNDLICHERE SAUBERKEIT DER OBERFLÄCHEN
Durch die integrierten antimikrobiellen Eigenschaften trägt Shield zur Vermeidung von Fleckenbildung durch Bakterienwachstum bei und hält die Oberflächen länger sauber.

TRÄGT DAZU BEI, UNANGENEHME GERÜCHE DURCH BAKTERIENWACHSTUM ABZUBAUEN
Hemmt die Bildung unangenehmer Gerüche und sorgt für ein angenehmes Wohnklima.

KEINE NEGATIVE AUSWIRKUNG AUF DIE ÄSTHETIK DER KERAMIKBELÄGE
Die Integration der Silberionen-Technologie in den Herstellungsprozess der Keramikfliesen hat keine negativen Auswirkungen auf die Ästhetik oder Qualität unserer Produkte.

AVANTAGES

ÉLIMINE JUSQU'À 99,9 % DES BACTÉRIES SUR LA SURFACE TRAITÉE
L'ingrédient actif aux ions argent aide à lutter contre la croissance des bactéries en les empêchant de survivre, de se reproduire et de coloniser la surface traitée.

UNE PROPRIÉTÉ DES SURFACES PLUS EN PROFONDEUR
Grâce à ses propriétés antimicrobiennes incorporées, Shield contribue à prévenir les tâches causées par la croissance bactérienne et permet de garder les surfaces plus propres plus longtemps.

CONTRIBUE À ÉLIMINER LES MAUVAISES ODEURS CAUSÉES PAR LA CROISSANCE BACTÉRIENNE
Contribue à prévenir la formation d'odeurs déplaisantes pour créer un habitat plus agréable à vivre.

AUCUN EFFET NÉGATIF SUR L'ESTHÉTIQUE DES SURFACES CÉRAMIQUES
L'incorporation dans le processus céramique de la technologie à base d'ions argent n'a aucun effet négatif sur l'esthétique ou la qualité de nos produits.

VENTAJAS

ELIMINA HASTA EL 99,9% DE LAS BACTERIAS DE LA SUPERFICIE TRATADA
El ingrediente activo a base de iones de plata ayuda a combatir la proliferación de las bacterias dificultando su supervivencia, su reproducción y la colonización de la superficie tratada.

LIMPIEZA MÁS PROFUNDA DE LAS SUPERFICIES
Gracias a sus propiedades antimicrobianas integradas, Shield contribuye a prevenir las manchas causadas por el crecimiento bacteriano y mantiene las superficies más limpias durante más tiempo.

AYUDA A ELIMINAR LOS MALOS OLORES CAUSADOS POR LA PROLIFERACIÓN BACTERIANA
Contribuye a prevenir la formación de malos olores haciendo así más agradable la vivienda.

NO OCASIONA NINGÚN IMPACTO NEGATIVO EN LA ESTÉTICA DE LAS SUPERFICIES CERÁMICAS
La integración de la tecnología a base de iones de plata en el proceso cerámico no ocasiona ningún impacto negativo en la estética ni la calidad de nuestros productos.

ПРЕИМУЩЕСТВА

УБИВАЕТ ДО 99,9% БАКТЕРИЙ НА ОБРАБОТАННОЙ ПОВЕРХНОСТИ
Активный ингредиент с ионами серебра помогает в борьбе с развитием бактерий, затрудняя их выживание, воспроизведение и распространение на обработанной поверхности.

БОЛЕЕ ГЛУБОКАЯ ОЧИСТКА ПОВЕРХНОСТЕЙ
Благодаря интегрированным антимикробным свойствам Shield помогает предотвращать образование пятен, вызванных размножением бактерий, и дольше содержит поверхности в чистоте.

ПОМОГАЕТ УСТРАНЯТЬ НЕПРИЯТНЫЕ ЗАПАХИ, ВЫЗВАННЫЕ РАЗМНОЖЕНИЕМ БАКТЕРИЙ
Помогает предотвращать образование неприятных запахов для создания более комфортных условий жизни.

ОТСУТСТВИЕ КАКОГО-ЛИБО ОТРИЦАТЕЛЬНОГО ВЛИЯНИЯ НА ЭСТЕТИКУ КЕРАМИЧЕСКИХ ПОВЕРХНОСТЕЙ
Интеграция технологии, использующей ионы серебра, в процесс производства керамики не имеет отрицательного влияния на эстетику или качество нашей продукции.

PLUS



TECNOLOGIA SOSTENIBILE



La tecnologia a base di argento integrata nel processo Shield ha dato prova nel tempo di essere sicura e può essere applicata a un'ampia gamma di prodotti di consumo, industriali e sanitari. La tecnologia è conforme ai requisiti previsti dalle autorità di regolamentazione a livello internazionale e non è pericolosa per l'ambiente.

PROTEZIONE PERENNE DELLE SUPERFICI



Non si degrada, non si usura e non si elimina con il lavaggio. La protezione antimicrobica integrata resta attiva 24/7 ed efficace per l'intero ciclo vitale del prodotto.

GRES RESISTENTE A MUFFE E FUNGHI



La ceramica Emilgroup si pulisce facilmente e in modo efficace con normali detergenti domestici e la sua superficie inerte non facilita la proliferazione di funghi e muffe.

EFFICACE SEMPRE, ANCHE AL BUIO



Shield si avvale di una tecnologia costantemente attiva con ogni condizione di luce, persino in assenza di raggi UV.

PLUS

SUSTAINABLE TECHNOLOGY

The silver-based technology integrated into the Shield process has a long history of safe use and can be found in a wide range of consumer, industrial and healthcare products. The technology is in full compliance with global regulatory bodies and is not hazardous for the environment.

PERMANENT SURFACE PROTECTION

Which will not wash off, wear away or leach out. Built-in antimicrobial protection remains active 24/7 and effective throughout the product's entire life cycle.

PORCELAIN STONEWARE RESISTANT TO MOLD AND FUNGI

Emilgroup ceramic can be easily and effectively cleaned with normal household detergents and its inert surface does not facilitate proliferation of fungi and molds.

ALWAYS EFFECTIVE, EVEN IN THE DARK

Shield contains a technology that's constantly active in all light conditions, even with no UV radiation.

PLUSPUNKTE

NACHHALTIGE TECHNOLOGIE

Die in das Shield-Verfahren integrierte Silberionen-Technologie hat sich als sicher bewährt und kann auf eine breite Palette von Konsumgütern, Industrieerzeugnissen und Sanitärprodukten angewendet werden. Die Technologie entspricht den Anforderungen internationaler Aufsichtsbehörden und ist nicht umweltgefährlich.

DAUERHAFTER SCHUTZ DER OBERFLÄCHEN

Kein Abbau, kein Verschleiß und kein Abtragen durch Reinigung. Der integrierte antimikrobielle Schutzschild bleibt rund um die Uhr aktiv und während des gesamten Lebenswegs des Produkts wirksam.

GEGEN SCHIMMEL UND PILZE RESISTENTES FEINSTEINZEUG

Die Keramik der Emilgroup lässt sich einfach und wirksam mit normalen Haushaltsreinigern reinigen. Die inerte Oberfläche hemmt die Vermehrung von Pilzen und Schimmel.

WIRKT IMMER, AUCH IM DUNKELN

Shield basiert auf einer Technologie, die ständig, unter jeder Lichtbedingung und sogar ohne UV-Licht aktiv ist.

AVANTAGES

UNE TECHNOLOGIE DURABLE

Cette technologie à base d'ions argent incorporée dans le processus Shield a fait la preuve de sa sécurité dans la durée. Elle peut s'appliquer à une gamme étendue de produits de consommation, industriels et sanitaires. Elle est conforme aux exigences des autorités réglementaires internationales et ne présente aucun danger pour l'environnement.

UNE PROTECTION PÉRENNE DES SURFACES

Elle ne se dégrade pas, ne s'use pas et ne s'élimine pas au lavage. La protection antimicrobienne incorporée reste active 24 h/24, 7j/7, et conserve son efficacité tout au long du cycle de vie du produit.

UN GRÈS CÉRAME RÉSISTANT AUX MOISSISSURES ET AUX CHAMPIGNONS

Le carrelage céramique Emilgroup peut se nettoyer de façon simple et efficace avec des détergents normaux à usage domestique. Sa surface inerte ne facilite pas la prolifération de champignons et moisissures.

UNE EFFICACITÉ PERMANENTE, MÊME DANS L'OBSCURITÉ

Shield repose sur une technologie constamment active dans toutes les conditions de lumière, y compris en l'absence de rayons UV.

VENTAJAS

TECNOLOGÍA SOSTENIBLE

La tecnología a base de plata integrada en el proceso Shield ha demostrado ser segura y poder aplicarse a una amplia gama de productos de consumo, industriales y sanitarios. La tecnología cumple los requisitos establecidos por las autoridades de reglamentación internacional y no es peligrosa para el medio ambiente.

PROTECCIÓN PERMANENTE DE LAS SUPERFICIES

No se degrada, no sufre desgaste y no se elimina con el lavado. La protección antimicrobiana integrada permanece activa 24/7 y es eficaz a lo largo de todo el ciclo de vida del producto.

GRES PORCELÁNICO RESISTENTE A MOHO Y HONGOS

La cerámica de Emilgroup se puede limpiar de modo sencillo y eficaz con los detergentes corrientes de uso doméstico; además, su superficie inerte no facilita la proliferación de hongos y moho.

EFICAZ SIEMPRE, INCLUSO EN LA OSCURIDAD

Shield se sirve de una tecnología constantemente activa con independencia de las condiciones luminosas, incluso en ausencia de rayos ultravioletas.

ПРЕИМУЩЕСТВА

ЭКОЛОГИЧЕСКИ РАЦИОНАЛЬНАЯ ТЕХНОЛОГИЯ

Интегрированная в производственный процесс технология использования серебра Shield доказала с течением времени свою безопасность и применимость в широком ассортименте потребительских, промышленных и санитарных товаров. Эта технология соответствует требованиям, предусмотренным регламентирующими органами на международном уровне и не является угрозой для окружающей среды.

ВЕЧНАЯ ЗАЩИТА ПОВЕРХНОСТЕЙ

Не портится, не изнашивается и не смывается во время чистки. Интегрированная антимикробная защита активна круглосуточно и эффективна в течение всего жизненного цикла изделия.

КЕРАМОГРАНИТ, УСТОЙЧИВЫЙ К ОБРАЗОВАНИЮ ПЛЕСЕНИ И ГРИБКОВ

Керамические изделия Emilgroup можно просто и эффективно чистить обычными бытовыми моющими средствами, а их инертная поверхность не способствует развитию грибов и плесени.

ВСЕГДА ЭФФЕКТИВНА, ДАЖЕ В ТЕМНОТЕ

Shield использует технологию, которая активна постоянно, при любом освещении, даже при отсутствии УФ-излучения.

DESTINAZIONI



**ISTITUTI MEDICI
 OSPEDALI
 CLINICHE
 AMBULATORI
 CASE DI RIPOSO
 SPA
 TERME
 PISCINE
 PALESTRE
 SCUOLE
 AEROPORTI
 STAZIONI
 ALBERGHI**

**INDUSTRIE
 E MERCATI
 AGRO-ALIMENTARI
 MATTATOI
 SERVIZI
 DI RISTORAZIONE
 UFFICI
 PUBBLICI
 E COMMERCIALI
 MENSE
 CUCINE E BAGNI
 PUBBLICI
 E PRIVATI**

INTENDED USES

- Medical Institutes
- Hospitals
- Clinics
- Doctors' Surgeries
- Care Homes
- Wellness Centres
- Spas
- Swimming Pools
- Gyms
- Schools
- Airports
- Stations
- Hotels
- Food Processing Plants and Markets
- Abattoirs
- Catering Services
- Public And Commercial Offices
- Canteens
- Public and Private Kitchens, Bathrooms and Washrooms

ANWENDUNGSBEREICHE

- Medizinische Institute
- Krankenhäuser
- Kliniken
- Arztpraxen
- Altersheime
- Spas
- Thermen
- Schwimmbäder
- Fitness-Studios
- Schulen
- Flughäfen
- Bahnhöfe
- Hotels
- Industriebetriebe Und Lebensmittelmärkte
- Schlachtbetriebe
- Gastronomiebetriebe
- Ämter Und Geschäftsbüros
- Kantinen
- Küchen, Öffentliche Toiletten Und Privatbäder

DOMAINES D'APPLICATION

- Établissements Médicaux
- Hôpitaux
- Cliniques
- Cabinets Médicaux
- Maisons De Retraite
- Spas
- Stations Thermales
- Piscines
- Salles De Sport
- Établissements Scolaires
- Aéroports
- Gares
- Hôtels
- Industries Et Marchés Agro-Alimentaires
- Abattoirs
- Services De Restauration
- Bureaux Publics Et Commerciaux
- Canteines
- Cuisines Et Salles De Bains Publiques Et Privées

APLICACIONES

- Centros Médicos
- Hospitales
- Clínicas
- Ambulatorios
- Residencias De Ancianos
- Spas
- Termas
- Piscinas
- Gimnasios
- Escuelas
- Aeropuertos
- Estaciones
- Hoteles
- Industrias y Mercados Agroalimentarios
- Mataderos
- Servicios De Restauración
- Oficinas Públicas Y Comerciales
- Comedores Públicos
- Cocinas Y Baños Públicos Y Privados

НАЗНАЧЕНИЕ

- Медицинские Учреждения
- Больницы
- Клиники
- Поликлиники
- Дома Престарелых
- Спа
- Термальные Заведения
- Бассейны
- Спортзалы
- Школы
- Аэропорты
- Вокзалы
- Гостиницы
- Агро-Пищевой Сектор И Агропром
- Скотобойни
- Заведения Общественного Питания
- Общественные Учреждения И Торговые Заведения
- Столовые
- Кухни, Общественные И Частные Туалетные Комнаты

CERTIFIED
MANAGEMENT SYSTEMS

CQY
CERTIQUALITY

UNI EN ISO 9001:2015
UNI EN ISO 14001:2015
UNI ISO 45001:2018
UNI CEI EN ISO 50001:2018

SISTEMA DI GESTIONE INTEGRATO

Emilgroup eccelle nel settore ceramico anche grazie al proprio Sistema di Gestione Integrato aziendale in materia di Qualità, Ambiente, Energia, Salute e Sicurezza dei Lavoratori. Una prova tangibile dell'impegno massimo e costante che il gruppo dedica, con approccio proattivo a queste fondamentali tematiche garantendo l'assoluto rispetto degli standard più elevati in tutte le fasi del ciclo di vita del prodotto.

Una gestione che consolida e accresce la competitività del gruppo sui mercati e permette all'azienda di valutare e definire le azioni da intraprendere per realizzare prodotti sicuri, di alta qualità, innovativi, che rispettano l'ambiente e la salute dei consumatori e dei lavoratori. Grazie all'integrazione e certificazione dei quattro sistemi di gestione

- QUALITÀ
- AMBIENTE
- ENERGIA
- SALUTE & SICUREZZA DEI LAVORATORI,

Emilgroup è stata premiata con il "GOLD EXCELLENCE AWARD", riconoscimento di eccellenza gestionale che l'istituto di certificazione CERTIQUALITY conferisce alle aziende particolarmente virtuose.

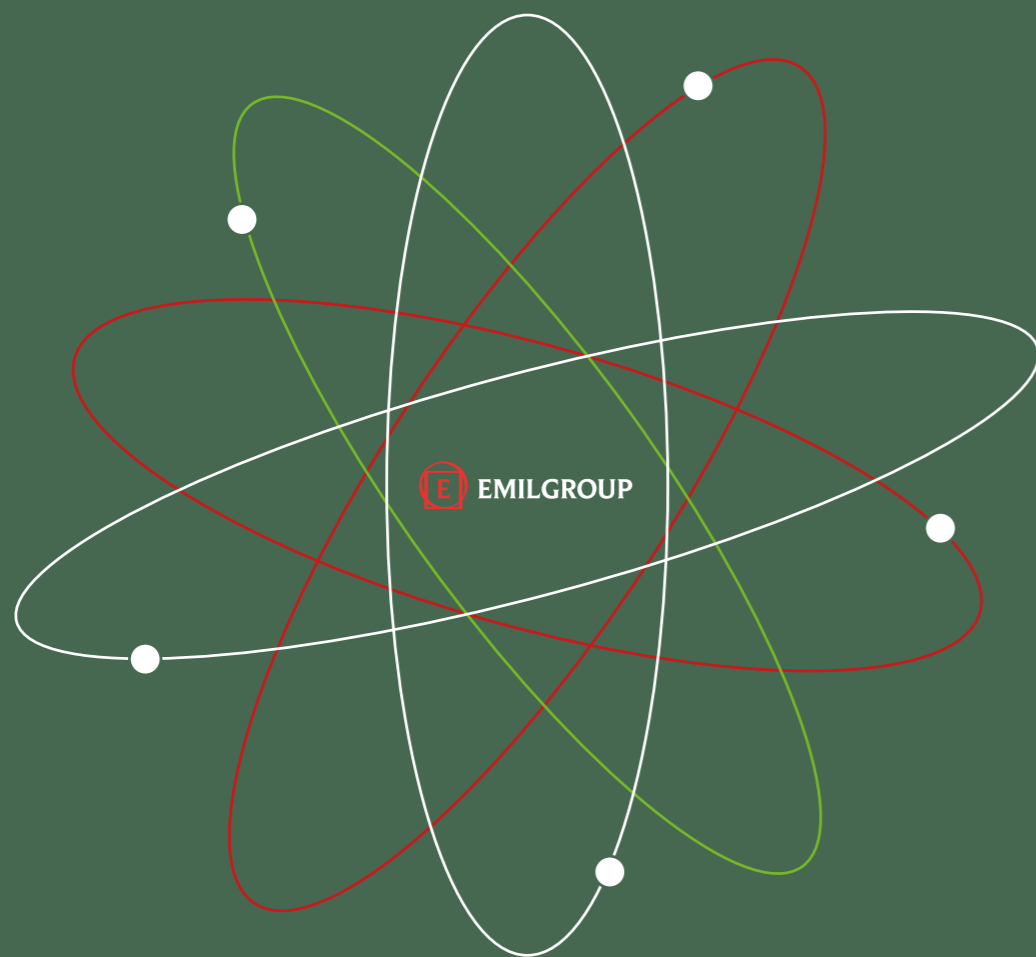

INTEGRATED MANAGEMENT SYSTEM

Emilgroup excels in the ceramics sector thanks also to its Integrated Management System in the area of Quality, the Environment, Energy and Occupational Health and Safety. Tangible proof of the significant and constant commitment the Group dedicates, with its proactive approach, to these essential areas, guaranteeing complete respect for the highest standards in all phases of the product life cycle.

A management approach that consolidates and increases the Group's competitiveness on the market and enables the company to evaluate and define the actions required to develop safe, innovative and high quality products that respect the environment and the health of consumers and workers.

Thanks to the integration and certification of its four management systems
- QUALITY - ENVIRONMENT - ENERGY - OCCUPATIONAL HEALTH AND SAFETY

Emilgroup has received the "GOLD EXCELLENCE AWARD" for managerial excellence assigned by the CERTIQUALITY certification institute to companies which excel in this field.

SYSTÈME DE GESTION INTÉGRÉ

L'excellence d'Emilgroup dans le secteur céramique repose aussi sur son Système de Management Intégré en matière de Qualité, d'Environnement, d'Énergie, de Santé et Sécurité au travail. S'inscrivant dans une démarche proactive, le groupe donne là une preuve tangible de son engagement total et constant en faveur de ces thématiques essentielles, dans le respect absolu des normes les plus élevées à toutes les étapes du cycle de vie du produit.

Cette gestion répond à un double objectif : renforcer et augmenter la compétitivité du groupe sur les marchés et permettre à l'entreprise d'évaluer et de mettre en œuvre des mesures pour fabriquer des produits sûrs, de haute qualité, innovants, respectueux de l'environnement et de la santé des consommateurs et des travailleurs.

Elle s'appuie sur l'intégration et la certification de quatre systèmes de management
- QUALITÉ - ENVIRONNEMENT - ÉNERGIE - SANTÉ ET SÉCURITÉ AU TRAVAIL

Emilgroup s'est vu remettre le « GOLD EXCELLENCE AWARD », un certificat témoignant de l'excellence en management que l'organisme de certification CERTIQUALITY décerne aux entreprises particulièrement vertueuses.

INTEGRIERTES MANAGEMENT SYSTEM

Die Emilgroup ist im Rahmen eines Integrierten Managementsystems in den Bereichen Qualität, Umweltschutz und Energie sowie Arbeits- und Gesundheitsschutz besonders gut aufgestellt. Ein greifbarer Beweis für 100 %-iges Engagement, das die Gruppe diesen grundsätzlichen Themenbereichen mit einem proaktiven Ansatz widmet, indem die unbedingte Einhaltung der höchsten Standards in allen Lebensphasen des Produkts garantiert wird.

Ein Management, das die Wettbewerbsfähigkeit der Gruppe auf den Märkten stärkt und ausbaut und es dem Unternehmen ermöglicht, die Maßnahmen zur Realisierung sicherer, hochwertiger und innovativer Produkte, die umweltfreundlich und unbedenklich für die Gesundheit der Verbraucher und Mitarbeiter sind, zu definieren und umzusetzen.

Für die Integration und Zertifizierung der Managementsysteme in den vier Bereichen

- QUALITÄT - UMWELT - ENERGIE - ARBEITS- UND GESUNDHEITSSCHUTZ

erhielt die Emilgroup den GOLD EXCELLENCE AWARD, den die Zertifizierungsstelle CERTIQUALITY besonders vorbildlichen Unternehmen verleiht.

SISTEMA DE GESTIÓN INTEGRADO

Emilgroup destaca en el sector cerámico en parte gracias a su Sistema de Gestión Integrado en la empresa en materia de Calidad, Medio Ambiente y Energía, Salud y Seguridad de los Trabajadores. Una prueba tangible del esfuerzo máximo y constante que hace el grupo, con una actitud proactiva, en relación con estos asuntos fundamentales es que se garantiza la plena observación de los estándares más elevados en todas las fases del ciclo de vida del producto.

Una gestión que consolida e incrementa la competitividad del grupo en los mercados y le permite a la empresa evaluar y definir las acciones que emprender para fabricar productos seguros, de alta calidad, innovadores, y que respeten el medio ambiente y la salud de los consumidores y los trabajadores.

Gracias a la integración y a la certificación de los cuatro sistemas de gestión
- CALIDAD - MEDIO AMBIENTE - ENERGÍA - SALUD Y SEGURIDAD DE LOS TRABAJADORES,

Emilgroup ha recibido el premio "GOLD EXCELLENCE AWARD", galardón de excelencia en la gestión que el organismo de certificación CERTIQUALITY otorga a empresas especialmente virtuosas.

ИНТЕГРИРОВАННАЯ СИСТЕМА МЕНЕДЖМЕНТА

Emilgroup лидирует в керамической отрасли также благодаря своей интегрированной системе корпоративного менеджмента в области качества, охраны окружающей среды, энергетики, здоровья и безопасности работников. Она является ярким подтверждением больших, постоянных и упреждающих усилий, которые предпринимает группа в этих фундаментально важных вопросах, гарантируя полное соблюдение самых высоких стандартов на всех этапах жизненного цикла изделия. Данное управление укрепляет и повышает конкурентоспособность группы на рынках и позволяет компании оценивать и определять предпринимаемые действия для производства безопасной, высококачественной, инновационной продукции, уважительно относящейся к окружающей среде и здоровью потребителей и работников.

Благодаря интеграции и сертификации четырех систем менеджмента
- КАЧЕСТВО - ОКРУЖАЮЩАЯ СРЕДА - ЭНЕРГЕТИКА - ЗДОРОВЬЕ И БЕЗОПАСНОСТЬ РАБОТНИКОВ,
Emilgroup удостоилась приза «GOLD EXCELLENCE AWARD» за совершенство управления, который сертифицирующий институт CERTIQUALITY присуждает особенно отличившимся компаниям.

QUALITÀ

Nel 1997 Emilgroup ha certificato il proprio sistema di gestione per la QUALITÀ secondo la norma ISO 9001.

Il principio guida di tutte le attività aziendali è la soddisfazione delle esigenze dei suoi clienti con prodotti dal design innovativo e dagli standard qualitativi affidabili, ottenuti attraverso il miglioramento continuo di prodotti e processi.

La qualità parte dalla scelta delle materie prime più pregiate che, grazie ad una progettazione estetica e funzionale all'avanguardia, a impianti di ultima generazione, all'applicazione rigorosa degli standard produttivi, sono garanzia di un prodotto che esprime la bellezza e tutto il valore del made in Italy.

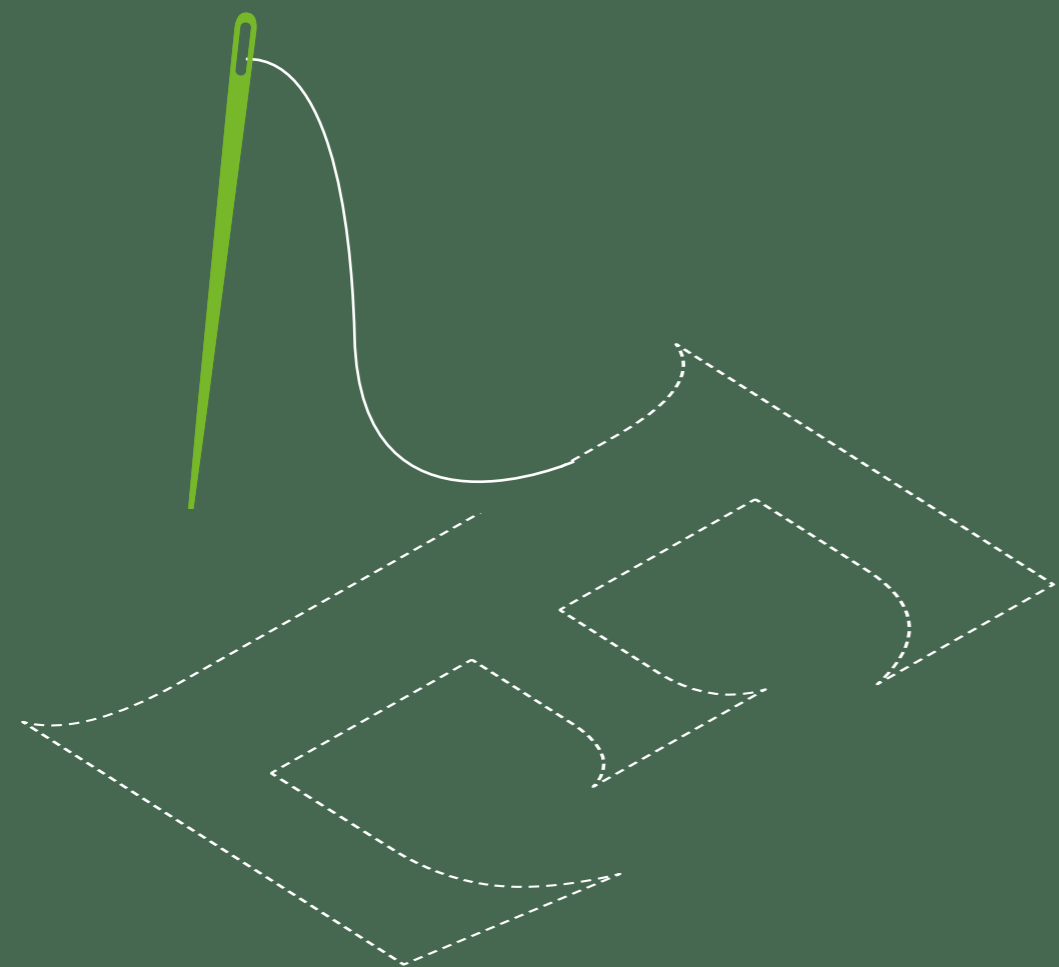

SISTEMA DI GESTIONE INTEGRATO

QUALITY

In 1997, Emilgroup certified its QUALITY management system according to the ISO 9001 standard. The company's guiding principle is the satisfaction of its customers' needs with innovative products of reliable standards of quality, produced thanks to continuous improvements to its processes and products. Quality begins with the choice of the finest raw materials which, thanks to cutting-edge aesthetic and functional designs, next-generation plants and the strict application of production standards, guarantee a product which embodies all the beauty and value of the Made in Italy label.

QUALITÉ

En 1997, Emilgroup a certifié son système de management de la QUALITÉ selon la norme ISO 9001. Un principe guide toutes les activités du groupe : satisfaire les exigences de ses clients en leur proposant des produits innovants et offrant des normes de qualité fiables, obtenus par l'amélioration continue des produits et des process. La qualité commence par le choix des meilleures matières premières. Grâce à une conception esthétique et fonctionnelle d'avant-garde, des équipements de dernière génération et l'application rigoureuse des normes de production, elles sont la garantie d'un produit qui exprime la beauté et l'excellence du Made in Italy.

QUALITÄT

1997 erlangte Emilgroup die Zertifizierung ihres Managementsystems für QUALITÄT nach der Norm ISO 9001. Aufbauend auf die kontinuierliche Verbesserung von Produkten und Prozessen sind alle Tätigkeiten darauf ausgerichtet, den Kundenbedürfnissen mit innovativem Design und zuverlässigen Qualitätsstandards gerecht zu werden. Die Qualität beginnt bei der Auswahl der hochwertigsten Rohstoffe, die dank einer zukunftsweisenden Planung in Ästhetik und Funktion, modernster Anlagen und der Einhaltung höchster Produktionsstandards die Garantie für ein Produkt sind, das die Schönheit und Wertigkeit des Made in Italy verkörpert.

CALIDAD

En 1997, Emilgroup certificó su sistema de gestión de la CALIDAD de conformidad con la norma ISO 9001. El principio que guía todas las actividades de la empresa es la satisfacción de las exigencias de sus clientes con productos de diseño innovador y con estándares cualitativos fiables, alcanzados gracias a la mejora continua de los productos y los procesos. La calidad es el resultado de la selección de las materias primas más preciadas, que —gracias a un diseño estético y funcional de vanguardia, a instalaciones de última generación y a la rigurosa aplicación de los estándares productivos— garantizan un producto que expresa la belleza y todo el valor del made in Italy.

КАЧЕСТВО

В 1997 году Emilgroup сертифицировала свою систему менеджмента КАЧЕСТВА на соответствие стандарту ISO 9001. Руководящим принципом всей корпоративной деятельности является удовлетворение потребностей своих клиентов продукцией с инновационным дизайном и надежными стандартами качества, получаемой путем непрерывного совершенствования как продукции, так и процессов. Качество начинается с выбора самого лучшего сырья, которое благодаря передовому проектированию эстетики и функциональности, производственным системам последнего поколения, строгому соблюдению стандартов качества, является залогом получения продукции, выражающей красоту и всю ценность клейма «made in Italy».

SALUTE E SICUREZZA DEI LAVORATORI

Emilgroup oltre a rispettare scrupolosamente quanto previsto dalla legislazione vigente, rafforza ed estende a 360° il proprio impegno in questo campo, attraverso i requisiti aggiuntivi previsti dal Sistema di Gestione per la Salute e la Sicurezza dei lavoratori, certificato dal 2014 come BS OHSAS 18001 e ora passato alla versione internazionale ISO 45001. I lavoratori e i loro rappresentanti sono coinvolti attivamente nel sistema di gestione con la segnalazione dei possibili miglioramenti, l'organizzazione delle squadre di emergenza, la formazione continua sui rischi e sull'uso dei dispositivi di protezione.



OCCUPATIONAL HEALTH AND SAFETY

As well as scrupulously respecting the provisions of the relevant legislation, Emilgroup strengthens and extends its commitment in this field right across the board by adopting the additional requisites of the Occupational Health and Safety Management System, certified according to the BS OHSAS 18001 standard since 2014 and now the international ISO 45001 version. Workers and their representatives are actively involved in the management system, suggesting possible improvements, organising emergency teams and undergoing continuous training on risks and the use of protective equipment.

SANTÉ ET SÉCURITÉ AU TRAVAIL

Outre le respect scrupuleux des dispositions réglementaires en vigueur, Emilgroup renforce et élargit son engagement tous azimuts en la matière en répondant aux critères supplémentaires du Système de management pour la Santé et la Sécurité au travail, certifié depuis 2014 en tant que BS OHSAS 18001 et passé depuis à la version internationale ISO 45001. Les travailleurs et leurs représentants participent activement au système de gestion à travers le signalement d'améliorations possibles, l'organisation d'équipes d'urgence, la formation continue sur les risques et l'utilisation des équipements de protection.

GESUNDHEITSSCHUTZ UND SICHERHEIT DER ARBEITNEHMER

Neben der strengen Erfüllung der geltenden Gesetzesanforderungen verstärkt und erweitert die Emilgroup ihr Engagement in diesem Bereich durch die Erfüllung der zusätzlichen Anforderungen des Arbeitsschutzmanagementsystems, das ab 2014 nach der Norm BS OHSAS 18001, die von der internationalen Version ISO 45001 abgelöst wurde, zertifiziert wurde. Alle Mitarbeiter und ihre Vertreter sind aktiv in das Managementsystem eingebunden. Dies bedeutet das Aufzeigen möglicher Verbesserungen, die Organisation von Notfallteams, die kontinuierliche Schulung über Risiken und den Gebrauch von Unfallschutzausrüstungen.

SALUD Y SEGURIDAD DE LOS TRABAJADORES

Emilgroup, además de cumplir escrupulosamente con todo lo previsto por la legislación vigente en materia de salud y seguridad en el trabajo, refuerza y amplía al máximo su compromiso adoptando los requisitos adicionales previstos por el Sistema de Gestión de Seguridad y Salud en el Trabajo, certificado desde 2014 a través de la norma BS OHSAS 18001 y en la actualidad pasado a la versión internacional ISO 45001. Los trabajadores y sus representantes se ven involucrados y participan de manera activa en el sistema de gestión, indicando posibles mejoras, organizando equipos de emergencia y recibiendo una formación continua sobre los riesgos y acerca del uso de los dispositivos de protección.

ЗДОРОВЬЕ И БЕЗОПАСНОСТЬ РАБОТНИКОВ

Помимо строгого соблюдения норм, предусмотренных действующим законодательством, Emilgroup увеличивает и расширяет на 360° свои усилия в этой сфере, выполняя дополнительные требования, предусмотренные системой менеджмента здоровья и безопасности работников, сертифицированной в 2014 году на соответствие стандарту BS OHSAS 18001, конвертированному в международный стандарт ISO 45001. Работники и их представители активно вовлекаются в эту систему менеджмента, сообщая о возможных улучшениях, организуя команды экстренных служб, проходя непрерывное обучение в вопросах рисков и использования средств защиты.

AMBIENTE

Nel 2011 Emilgroup ha certificato il proprio sistema di gestione ambientale implementato secondo la norma ISO 14001. In un'ottica globale di "life cycle perspective", l'azienda è quotidianamente impegnata nella definizione di prodotti e processi volti a ridurre l'impatto ambientale, adottando un approccio trasparente, collaborativo e previdente.

- Già nel 1982 Emilgroup è stata una delle prime aziende del settore ad instaurare un ciclo chiuso delle acque. Tali acque provenienti dagli stabilimenti produttivi, dopo essere state depurate con trattamenti chimico-fisici vengono integralmente riciclate, senza che vi sia nell'ambiente alcuno scarico di acque industriali.
- Dal 1989 Emilgroup ricicla totalmente gli scarti da lavorazione poiché riutilizza all'interno dei suoi impasti tutti gli scarti crudi e i fanghi ceramici limitando la generazione di rifiuti. Inoltre, recupera scarti produttivi da altre aziende ceramiche del comprensorio, secondo quanto previsto da specifica autorizzazione.
- I rifiuti interni vengono attentamente differenziati e inviati al recupero presso ditte autorizzate.
- Le emissioni in atmosfera sono costantemente controllate e ben al di sotto dei limiti previsti dalle autorizzazioni, grazie ad un'attenta gestione degli impianti.
- Si utilizzano inchiostri a base acquosa per la decorazione digitale, che garantiscono l'abbattimento degli odori e non contengono sostanze dannose per gli operatori.

ENVIRONMENT

In 2011 Emilgroup certified its environmental management system implemented according to the ISO 14001 standard. Adopting a "life cycle perspective", the company is committed, on a daily basis, to developing products and processes aimed at reducing environmental impact, adopting an approach based on transparency, cooperation and prevention.

- As early as 1982 Emilgroup became one of the first companies in the industry to install a closed water cycle. After undergoing chemical-physical treatment, all wastewater from the production plants is completely recycled without any industrial water discharged into the environment.
- Emilgroup has recycled all of its processing waste since 1989, reusing all unfired reject tiles and ceramic sludge in its body mixes and limiting the generation of waste. It also recovers production waste from other ceramic companies in the district, as per a specific authorisation.
- Internal waste is carefully sorted and sent for recovery at authorised companies.
- Atmospheric emissions are constantly monitored and well below the limits established by the authorisations thanks to the careful management of the plants.
- The water-based inks used for digital decoration reduce odours and do not contain any harmful substances for operators.

ENVIRONNEMENT

En 2011, Emilgroup a certifié son système de management environnemental mis en œuvre selon la norme ISO 14001. Dans une optique globale de « perspective de cycle de vie », le groupe s'engage tous les jours à développer des produits et des procédures qui réduisent l'impact sur l'environnement, en adoptant une démarche transparente, collaborative et prévoyante.

- Dès 1982, Emilgroup a été l'une des premières entreprises du secteur à instaurer un circuit fermé des eaux de production. Après avoir été épurées par un traitement physico-chimique, les eaux provenant des établissements de production sont entièrement recyclées, sans aucun rejet d'eaux industrielles dans l'environnement.
- Depuis 1989, Emilgroup recycle totalement les déchets de production puisqu'il réutilise dans ses pâtes l'ensemble des déchets de production non cuits et les boues céramiques, limitant ainsi la création de déchets. Par ailleurs, conformément aux dispositions d'une autorisation spécifique, il récupère les déchets de production d'autres entreprises de céramique du district.
- Les déchets internes sont soigneusement triés et envoyés à des entreprises agréées pour être valorisés.
- Les émissions dans l'atmosphère sont constamment surveillées et, grâce à une gestion rigoureuse des installations, se situent bien en dessous des limites fixées par les autorisations.
- Les encres à base d'eau sont utilisées pour la décoration numérique. Elles garantissent l'élimination des odeurs et ne contiennent pas de substances nocives pour les opérateurs.

UMWELTSCHUTZ

Im Jahr 2011 erlangte Emilgroup die Zertifizierung für ihr nach der Norm ISO 14001 umgesetztes Umweltmanagementsystem. Unter dem ganzheitlichen Ansatz der Lebenszyklusperspektive arbeitet das Unternehmen transparent, kollaborativ und vorausschauend an der Entwicklung von nachhaltigen Produkten und Prozessen.

- Bereits 1982 war Emilgroup eines der ersten Unternehmen der Keramikbranche, das einen geschlossenen Wasserkreislauf einführte. Die Abwässer der Werke werden mit Hilfe von chemischen und physikalischen Verfahren geklärt und vollständig recycelt, so dass keine Industrieabwässer in die Umwelt gelangen.
- Zur Reduzierung der Abfallerzeugung recycelt Emilgroup seit 1989 alle Produktionsabfälle, d.h. ungebrannte Abfälle und keramische Schlämme werden vollständig in die Aufbereitung der Rohstoffmassen zurückgeführt. Außerdem recycelt sie aufgrund einer Sondergenehmigung die Produktionsabfälle anderer Keramikunternehmen des Gebiets.
- Die betriebsinternen Abfälle werden sorgfältig getrennt und zum Recycling an autorisierte Stellen abgeführt.
- Die in die Luft abgegebenen Emissionen werden ständig überwacht und liegen dank einer umsichtigen Bewirtschaftung der Anlagen unter den von den Genehmigungen vorgesehenen Grenzwerten.
- Für die Dekoration mit Digitaldruck werden Druckfarben auf Wasserbasis verwendet, die geruchsneutral sind und keine gesundheitsschädlichen Stoffe enthalten.

MEDIO AMBIENTE

En 2011, Emilgroup certifi  su sistema de gesti n medioambiental implantado de conformidad con la norma ISO 14001. Con arreglo a un enfoque global de ciclo de vida la empresa se esfuerza d a tras d a en la definici n de productos y procesos orientados a reducir el impacto medioambiental, adoptando un planteamiento transparente, previsor y de colaboraci n.

- Ya en 1982 Emilgroup fue una de las primeras empresas del sector en introducir un ciclo cerrado de aguas. Las aguas procedentes de las f bricas, tras ser depuradas mediante tratamientos f sico-qu micos, son recicladas por entero, de manera que se evita todo vertido de aguas industriales.
- Desde 1989 Emilgroup recicla por completo, introduci ndolos en sus masas, todos los lodos cer micos y restos crudos de fabricaci n, limitando as  la generaci n de desechos. Adem s recicla los restos de fabricaci n de otras empresas cer micas del mismo polo productivo, de acuerdo con lo previsto por un permiso espec fico.
- Los residuos internos son seleccionados rigurosamente y se env an a empresas autorizadas para su reciclaje.
- Las emisiones a la atm sfera son controladas constantemente y se mantienen muy por debajo de los l mites previstos por las autorizaciones, gracias a una esmerada gesti n de los establecimientos productivos.
- En los procesos de decoraci n digital se utilizan tintas a base de agua que permiten reducir los olores y no contienen sustancias da inas para los trabajadores.

ОКРУЖАЮЩАЯ СРЕДА

В 2011 году Emilgroup сертифицировала свою систему экологического менеджмента на соответствие стандарту ISO 14001. В глобальном видении «перспектив жизненного цикла» компания ежедневно работает над определением продукции и процессов, снижающих воздействие на окружающую среду, используя в этом подход в духе прозрачности, сотрудничества и упреждения.

- Уже в 1982 году Emilgroup стала одной из первых компаний в этой отрасли, наладившей закрытый цикл использования воды. Сточные воды с производственных предприятий проходят очистку химико-физической обработкой и полностью повторно используются, без каких-либо сбросов промышленной воды в окружающую среду.
- С 1989 года Emilgroup полностью повторно использует производственные отходы, добавляя в свои смеси весь сырой брак и керамический шлам, что снижает объем производимых отходов. Кроме того, она вывозит производственные отходы с других керамических предприятий в этом кластере, действуя в соответствии с положениями специального разрешения.
- Внутренние отходы тщательно сортируются и отправляются на переработку в авторизованные компании.
- Выбросы в атмосферу постоянно проверяются и находятся на гораздо более низких уровнях, чем предусмотрено в разрешениях. Это обеспечивается внимательным управлением системами.
- Для цифровой печати используются красители на водной основе, которые снижают образование запахов и не содержат вредных веществ для операторов.

ENERGIA

Nel 2016 Emilgroup ha certificato il proprio Sistema di Gestione dell'Energia secondo la norma ISO 50001, segno tangibile del proprio impegno quotidiano per un uso dell'energia consapevole, attento e responsabile.

L'Azienda persegue il risparmio energetico grazie al monitoraggio continuo dei consumi, agli interventi di miglioramento sugli impianti produttivi, all'autoproduzione di energia tramite cogeneratore, al recupero di calore residuo che viene riutilizzato nella produzione e per il riscaldamento dei reparti.

SISTEMA DI GESTIONE INTEGRATO

ENERGY

In 2016 Emilgroup certified its Energy Management System according to the ISO 50001 standard, tangible proof of its daily commitment to the informed, attentive and responsible use of energy. The company pursues energy savings through the continuous monitoring of its consumption, the improvements carried out to its production plants, the self-production of energy through the cogenerator and the recovery of residual heat which is reused in production and for heating the departments.

ÉNERGIE

En 2016, Emilgroup a certifié son système de management de l'énergie selon la norme ISO 50001, concrétisant ainsi son engagement quotidien en faveur d'une utilisation consciente, rigoureuse et responsable de l'énergie. Les économies d'énergie que poursuit l'entreprise reposent sur les éléments suivants : contrôle continu de la consommation, améliorations sur les installations de production, autoproduction d'énergie au moyen d'un cogénérateur, récupération de la chaleur résiduelle qui est réutilisée dans la production et pour le chauffage des ateliers et services.

ENERGIE

2016 hat Emilgroup sein Energiemanagementsystem nach ISO 50001 zertifiziert. Dies ist ein deutliches Zeichen ihres täglichen Einsatzes für einen bewussten, aufmerksamen und verantwortlichen Energieverbrauch. Das Unternehmen setzt konsequent auf Energieeinsparung durch ständige Verbrauchsüberwachung, Verbesserung der Effizienz der Produktionsanlagen, Selbsterzeugung von Energie mittels Kraft-Wärme-Kopplungsanlage und Nutzung von Restwärme, die in der Produktion und zur Heizung der Abteilungen wiederverwertet wird.

ENERGÍA

En 2016 Emilgroup certificó su Sistema de Gestión de la Energía, implantado de conformidad con la norma ISO 50001, signo tangible de su compromiso cotidiano con un uso consciente, diligente y responsable de la energía. La empresa persigue el ahorro energético a través de la monitorización continua del consumo, de las intervenciones de mejora de las instalaciones de fabricación, de la autoproducción de energía por medio de cogeneradores, y de la recuperación del calor residual, que se reutiliza en la producción y para la calefacción de los varios departamentos.

ЭНЕРГОЭФФЕКТИВНОСТЬ

В 2016 году Emilgroup сертифицировала свою систему энергетического менеджмента на соответствие стандарту ISO 50001, которая является весомым доказательством своих ежедневных усилий в области осознанного, внимательного и ответственного использования энергии. Компания осуществляет энергосбережение благодаря непрерывному мониторингу потребления, усовершенствованиям производственных систем, самостоятельному когенерационному производству энергии, рекуперации остаточного тепла, которое повторно используется на производстве и для отопления цехов.

RESPONSABILITÀ

La politica aziendale di Emilgroup è da sempre basata sul rispetto dell'ambiente, della salute delle persone e del tessuto socio-economico in cui opera.

Durante gli anni l'azienda si è impegnata a concretizzare i valori dell'edilizia sostenibile, con il costante miglioramento degli impatti del processo produttivo, l'attenzione alla salubrità del prodotto, la salvaguardia della salute e sicurezza di tutti i lavoratori, e non ultimo il sostegno alle persone e al territorio locale.



RESPONSABILITÀ

RESPONSIBILITY

The Emilgroup corporate policy has always been based on respect for the environment, people's health and the socioeconomic fabric of the community in which it operates. Over the years the company has sought to implement the values of sustainable construction by constantly improving the impact of its production process, focusing on the healthiness of its products, safeguarding the health and safety of all workers and, last but not least, supporting people and the local area.

RESPONSABILITÉ

Depuis toujours, Emilgroup fonde sa politique d'entreprise sur le respect de l'environnement, de la santé de ses collaboratrices et collaborateurs et du tissu socio-économique dans lequel il est implanté. Au fil des ans, l'entreprise s'est attachée à traduire concrètement les valeurs de la construction durable. Pour ce faire, elle s'est appuyée sur l'amélioration continue des impacts du processus de production, l'attention portée à la salubrité du produit, la préservation de la santé et de la sécurité de tous les travailleurs et, enfin et surtout, le soutien à la population et au territoire local.

VERANTWORTUNG

Die Unternehmenspolitik von Emilgroup basiert seit jeher auf dem Umweltschutz, auf der Gesundheit des Menschen und des sozioökonomischen Umfelds, in dem er tätig ist. Im Verlauf der Jahre setzte sich das Unternehmen dafür ein, die Werte des nachhaltigen Bauens konkret umzusetzen. Dies bedeutet: konstante Reduzierung der Umweltbelastung des Produktionsprozesses, ein Augenmerk auf die gesundheitliche Unbedenklichkeit des Produkts, Gesundheitsschutz und Sicherheit aller Mitarbeiter und nicht zuletzt die Unterstützung der Standortregion und der darin lebenden Menschen.

RESPONSABILIDAD

La política empresarial de Emilgroup se ha basado siempre en el respeto por el medio ambiente, la salud de las personas y el tejido socioeconómico en el que opera. A lo largo de los años la empresa se ha esforzado de manera concreta para preservar los valores de la construcción sostenible, con una constante mejora del impacto del proceso productivo, velando por la salubridad del producto, la salvaguardia de la salud y la seguridad de todos los trabajadores, y el apoyo a las personas y al territorio local.

ОТВЕТСТВЕННОСТЬ

Корпоративная политика Emilgroup всегда основывалась на уважении к окружающей среде, к здоровью людей и социально-экономической среде, в которой она работает. За прошедшие годы компания работала над конкретным применением ценностей экологически рационального строительства, постоянно смягчая воздействие производственного процесса, уделяя внимание безопасности продукции для здоровья, охране здоровья и безопасности всех сотрудников, и, что не менее важно, поддержке людей и территории.

EDILIZIA SOSTENIBILE



LEED

Emilgroup promuove i principi dell'edilizia sostenibile. Per questo dal 2008 è membro del Green Building Council americano (USGBC) e dal 2010 è socio del Green Building Council Italia (GBC Italia), dei quali recepisce e condivide i regolamenti, realizzando prodotti in accordo con i principi della certificazione LEED (Leadership in Energy and Environmental Design). La certificazione LEED valuta e attesta la sostenibilità ambientale, sociale ed economica degli edifici dalla fase di progettazione fino alla gestione quotidiana.

Tutti i prodotti Emilgroup contribuiscono all'ottenimento di crediti LEED nelle aree Materiali e risorse (MR), Sito sostenibile (SS), Qualità ambientale interna (EQ).

CAM

Emilgroup realizza i propri prodotti rispettando i requisiti previsti dai CAM (criteri minimi ambientali) che definiscono le caratteristiche di sostenibilità dei materiali da costruzione utilizzati nelle opere pubbliche. Questi parametri impongono valori soglia da rispettare per ridurre il consumo di acqua nel ciclo produttivo, per aumentare il recupero delle acque di processo e dei rifiuti legati all'attività produttiva, per diminuire le emissioni nell'aria e nell'acqua. Il rispetto dei requisiti è verificato all'interno dell'EPD.



SUSTAINABLE CONSTRUCTION

LEED - Emilgroup promotes the principles of sustainable construction. For this reason it has been a member of the US Green Building Council (USGBC) since 2008 and the Green Building Council Italia (GBC Italia) since 2010, implementing and adopting their rules by manufacturing products in accordance with the principles of LEED (Leadership in Energy and Environmental Design) certification. LEED certification assesses and certifies the environmental, social and economic sustainability of buildings from the design phase through to routine management.

All Emilgroup products contribute to obtaining LEED credits in the Materials and resources (MR), Sustainable site (SS) and internal Environmental Quality (EQ) areas.

CAM - Emilgroup makes all of its products in accordance with the CAM (minimum environmental criteria) which define the sustainability characteristics of the construction materials used in public works. These parameters lay down threshold values which must be respected in order to reduce water consumption in the production cycle, increase the recovery of process water and waste connected with production activities, and reduce air and water emissions. Respect for these requirements is verified in the EPD.

CONSTRUCTION DURABLE

LEED - Emilgroup promeut les principes de la construction durable C'est à ce titre que, depuis 2008, le groupe est membre du Green Building Council américain (USGBC) et, depuis 2010, du Green Building Council Italia (GBC Italia), dont il reconnaît et partage les règlements, en fabriquant des produits en accord avec les principes de la certification LEED (Leadership in Energy and Environmental Design). La certification LEED évalue et atteste la durabilité environnementale, sociale et économique des bâtiments, depuis l'étude de projets jusqu'à la gestion quotidienne.

Tous les produits Emilgroup contribuent à l'obtention de crédits LEED dans les domaines Matériaux et ressources (MR), Sites durables (SS), Qualité de l'environnement intérieur (EQ).

CAM - Emilgroup fabrique ses produits dans le respect des exigences des CAM (critères environnementaux minimaux) qui définissent les caractéristiques de durabilité des matériaux de construction utilisés dans les travaux publics. Ces paramètres imposent des valeurs seuils à respecter afin de réduire la consommation d'eau dans le cycle de production, d'augmenter la récupération des eaux de traitement et des déchets liés aux activités de production et de réduire les émissions dans l'air et dans l'eau. Le respect des exigences est vérifié dans la DEP.

NACHHALTIGES BAUEN

LEED - Emilgroup fördert die Grundsätze des nachhaltigen Bauens. Deshalb ist sie seit 2008 Mitglied des amerikanischen Green Building Council (USGBC) und seit 2010 Mitglied des Green Building Council Italia (GBC Italia), dessen Regelwerk die Unternehmensgruppe mit der Herstellung von Produkten gemäß den Zertifizierungskriterien des Systems LEED (Leadership in Energy and Environmental Design) umsetzt und teilt. Die LEED-Zertifizierung dient zur Beurteilung und Bescheinigung der ökologischen, sozialen und wirtschaftlichen Nachhaltigkeit von Gebäuden, beginnend bei der Planung bis hin zur Nutzung.

Alle Produkte von Emilgroup tragen zur Erlangung von LEED Punkten in den Bewertungskategorien Materialien und Ressourcen (MR), Nachhaltige Baugelände (SS), Komfort und Raumqualität (EQ) bei.

CAM - Emilgroup fertigt ihre Produkte gemäß den Anforderungen der Mindestumweltkriterien (CAM), die die Nachhaltigkeitseigenschaften der im Objektbau verwendeten Baumaterialien definieren. Diese Parameter schreiben einzuhaltende Schwellenwerte vor, um den Wasserverbrauch im Produktionszyklus zu reduzieren, die Rückgewinnung der Prozesswasser und Produktionsabfälle zu steigern und die Emissionen in Luft und Wasser zu vermindern. Die Einhaltung der Anforderungen wird im Rahmen der Umwelt-Produktdeklaration (EPD) überprüft.

CONSTRUCCIÓN SOSTENIBLE

LEED - Emilgroup promueve los principios de la construcción sostenible. Por ello desde 2008 Emilgroup es miembro del Green Building Council estadounidense (USGBC) y desde 2010 es socio del Green Building Council Italia (GBC Italia) cuyos reglamentos acepta y comparte, realizando productos de acuerdo con los principios de la certificación LEED (Leadership in Energy and Environmental Design). La certificación LEED evalúa y da fe de la sostenibilidad medioambiental, social y económica de los edificios desde su proyección hasta su gestión diaria.

Todos los productos de Emilgroup contribuyen a la consecución de créditos LEED en las áreas de materiales y recursos (MR), sitios sostenibles (SS), calidad ambiental interna (EQ).

CAM - Emilgroup fabrica sus productos observando los requisitos establecidos con arreglo a los criterios medioambientales mínimos (CAM) que definen las características de sostenibilidad de los materiales de construcción utilizados en las obras públicas. Estos parámetros imponen unos valores límite que deben cumplirse para reducir el consumo de agua en el ciclo productivo, para incrementar la recuperación de las aguas del proceso de fabricación y de los residuos ligados a la actividad productiva, con el fin de disminuir las emisiones al aire y los vertidos en el agua. La observación de los requisitos se verifica dentro del EPD.

ЭКОЛОГИЧЕСКИ-РАЦИОНАЛЬНОЕ СТРОИТЕЛЬСТВО

LEED - Emilgroup продвигает принципы экологически рационального строительства. По этой причине с 2008 года она является членом американской Green Building Council (USGBC), а с 2010 года - членом Green Building Council Italia (GBC Italia), соблюдая и выполняя их регламенты и производя продукцию, соответствующую принципам сертификации LEED (Leadership in Energy and Environmental Design). Сертификация LEED оценивает и подтверждает экологическую, социальную и экономическую рациональность зданий, начиная с этапа проектирования, вплоть до ежедневного управления.

Вся продукция Emilgroup способствует получению кредитов LEED в сфере Материалы и ресурсы (MR), Экологически-рациональные объекты (SS), Качество внутренней среды (EQ).

МКОС - Emilgroup производит свою продукцию с соблюдением требований, предусмотренных МКОС (минимальные критерии окружающей среды), определяющих характеристики экологической рациональности строительных материалов, используемых на общественных объектах. Эти параметры предписывают пороговые значения, которые должны соблюдаться для снижения потребления воды в производственном процессе, для увеличения повторного использования технологической воды и отходов производственного процесса, для снижения выбросов в атмосферу и стоков в водоемы. Соблюдение требований проверяется в рамках Экологической декларации продукции (ЭДП).

EDILIZIA SOSTENIBILE



EPD e ANALISI DEL CICLO DI VITA (LCA)

Durante gli anni l'azienda si è impegnata a concretizzare progetti per ridurre l'impatto dei suoi prodotti e processi. Già a partire dal 2012 ha implementato lo studio LCA per valutarne gli effetti ambientali lungo l'intero ciclo di vita, dall'estrazione delle materie prime alla lavorazione, per poi passare alla distribuzione del prodotto, alla sua installazione e manutenzione, fino alla rimozione con recupero o smaltimento. I risultati ottenuti soprattutto da dati primari dell'azienda e non solo da database generali, sono stati verificati e pubblicati nell'EPD (ENVIRONMENTAL PRODUCT DECLARATION) che garantisce una comunicazione trasparente verso i consumatori. L'EPD concorre all'ottenimento di crediti LEED.

GESTIONE DELLE CAVE

La tutela dell'ambiente in Emilgroup parte dalla selezione di fornitori di materie prime, tutte provenienti da cave autorizzate e con piani di ripristino ambientale secondo le normative internazionali per il rispetto dell'habitat.

Il recupero interno dei materiali di processo permette a Emilgroup di diminuire l'estrazione di materie vergini e di ridurre il trasporto verso gli stabilimenti produttivi.

CONTENUTO DI MATERIALE RICICLATO

Nell'ottica di realizzare un'economia circolare, Emilgroup recupera nella maggior parte dei suoi prodotti scarti di produzione provenienti da altre aziende ceramiche del comprensorio e seleziona materie prime contenenti una determinata quantità di materiale di riciclo. La percentuale di materiale riciclato dei prodotti è valorizzata nei crediti LEED.

SUSTAINABLE CONSTRUCTION

EPD and LIFE CYCLE ASSESSMENT (LCA) - Over the years the company has sought to implement projects which reduce the environmental impact of its products and processes. Back in 2012 it implemented an LCA to evaluate environmental effects right throughout the entire life cycle, from the extraction of raw materials to processing, the distribution of the product, its installation and maintenance, and through to its removal with recovery or disposal. The results obtained above all from the company's primary data and not just from general databases were verified and published in the EPD (ENVIRONMENTAL PRODUCT DECLARATION) which guarantees transparent communications to consumers. The EPD contributes to the attainment of LEED credits.

QUARRY MANAGEMENT - At Emilgroup environmental protection begins with selecting suppliers of raw materials, all of which come from authorised quarries with environmental remediation plans in line with international regulations for the protection of habitats. The internal recovery of process materials enables Emilgroup to reduce the extraction of virgin materials and reduce their transportation towards production sites.

CONTENT OF RECYCLED MATERIAL - With the aim of creating a circular economy, Emilgroup reuses production waste from other ceramic companies in the district in the majority of its products and chooses raw materials containing a certain quantity of recycled material. The percentage of recycled material in the products is rewarded with LEED credits.

CONSTRUCTION DURABLE

DEP et ANALYSE DU CYCLE DE VIE (ACV) - Au fil des ans, l'entreprise s'est attachée à concrétiser des projets visant à réduire l'impact de ses produits et procédés. Dès 2012, elle a mis en œuvre l'étude ACV pour évaluer les effets sur l'environnement tout au long du cycle de vie, de l'extraction des matières premières à la transformation, en passant par la distribution du produit, son installation et son entretien, jusqu'à son retrait avec récupération ou élimination. Les résultats obtenus principalement à partir des données initiales de l'entreprise, et pas seulement à partir de bases de données générales, ont été vérifiés et publiés dans la DEP (DÉCLARATION ENVIRONNEMENTALE DE PRODUIT) qui assure une communication transparente aux consommateurs. La DEP concourt à l'obtention de crédits LEED.

GESTION DES CARRIÈRES - Chez Emilgroup, la protection de l'environnement commence par la sélection des fournisseurs de matières premières, provenant toutes de carrières autorisées et dotées de plans de remise en état des sites conformes aux réglementations internationales en matière d'habitat. La récupération en interne des matériaux de processus permet à Emilgroup de diminuer l'extraction de matériaux vierges et de réduire leur transport vers les usines de production.

CONTENU DE MATÉRIEAUX RECYCLÉS - S'inscrivant dans une démarche d'économie circulaire, Emilgroup récupère dans la plupart de ses produits des déchets de production provenant d'autres entreprises de céramique du district et sélectionne des matières premières contenant une quantité donnée de matériaux recyclés. Le pourcentage de matériaux recyclés dans les produits est pris en compte dans les crédits LEED.

NACHHALTIGES BAUEN

EPD und Lebenszyklusanalyse (LCA) - Das Unternehmen verwirklichte daher die folgenden Projekte zur Senkung der Umweltbelastung der Produkte und Prozesse. Bereits ab 2012 führte es die Lebenszyklusanalyse LCA ein, um die Umweltauswirkungen der Produkte während des gesamten Lebensweges, vom Abbau der Rohstoffe bis hin zu ihrer Verarbeitung, vom Vertrieb des Produkts bis zu seiner Verlegung, Pflege und Instandhaltung und sogar bis zu seiner Entfernung mit Recycling oder Entsorgung zu überprüfen. Die erhaltenen Ergebnisse, vor allem aus den Primärdaten des Unternehmens und nicht nur aus allgemeinen Datenbanken, wurden im Rahmen der EPD (UMWELT-PRODUKTDEKLARATION), die eine transparente Verbraucherkommunikation gewährleistet, überprüft und veröffentlicht. Die EPD trägt zur Zuerkennung von LEED-Punkten bei.

MANAGEMENT DER LAGERSTÄTTEN - Bei Emilgroup beginnt der Umweltschutz mit der Auswahl der Zulieferer von Rohstoffen, die alle aus autorisierten Lagerstätten mit Rekultivierungsplänen entsprechend den internationalen Rechtsvorschriften für die Sanierung des Lebensraums stammen. Die Rückgewinnung der Prozessmaterialien ermöglicht es Emilgroup, den Rohstoffabbau und somit deren Transport zu den Werken zu reduzieren.

RECYCLINGANTEIL - Zur Umsetzung einer Kreislaufwirtschaft recycelt Emilgroup in den meisten ihrer Produkte Produktionsabfälle von anderen Keramikunternehmen des Gebiets und wählt Rohstoffe mit einem bestimmten Anteil an Recyclingmaterial aus. Der Recyclinganteil in den Produkten trägt zur Gewinnung von LEED-Punkten bei.

CONSTRUCCIÓN SOSTENIBLE

EPD y ANÁLISIS DEL CICLO DE VIDA (LCA) - A lo largo de los años la empresa se ha esforzado por llevar a cabo proyectos con el objeto de reducir el impacto de sus productos y procesos de fabricación. Ya en 2012 implementó el estudio de análisis del ciclo de vida (LCA) para evaluar sus efectos en el medio ambiente en el curso de todo el ciclo de vida, desde la extracción de las materias primas hasta su elaboración, para después pasar a la distribución del producto, a su instalación y mantenimiento, hasta su retirada mediante reciclaje o eliminación. Los resultados conseguidos, según datos originales de la empresa y no solo según bases de datos generales, se han comprobado y publicado en la declaración ambiental de producto (EPD, ENVIRONMENTAL PRODUCT DECLARATION), que garantiza una comunicación transparente a los consumidores. La EPD contribuye a la obtención de créditos LEED.

GESTIÓN DE LAS CANTERAS - La protección del medio ambiente en Emilgroup comienza a partir de la selección de los proveedores de materias primas, todas ellas procedentes de canteras autorizadas y con planes de recuperación medioambiental de conformidad con las normativas internacionales que velan por el respeto del hábitat. El reciclaje interno de los materiales empleados en el proceso de producción le permite a Emilgroup disminuir la extracción de materias vírgenes y reducir su transporte a las fábricas.

CONTENIDO DE MATERIAL RECICLADO - De acuerdo con un enfoque de economía circular, Emilgroup recicla, incorporándolos a la mayor parte de sus productos, residuos de fabricación provenientes de otras empresas cerámicas de su mismo polo productivo y selecciona materias primas que contienen una determinada cantidad de material reciclado. El porcentaje de material reciclado de los productos es premiado con créditos LEED.

ЭКОЛОГИЧЕСКИ-РАЦИОНАЛЬНОЕ СТРОИТЕЛЬСТВО

ЭДП и ОЦЕНКА ЖИЗНЕННОГО ЦИКЛА (ОЖЦ) - За последние годы компания работала над конкретизацией проектов по снижению воздействия на окружающую среду своей продукции и производственных процессов. Уже в 2012 году она начала исследование ОЖЦ для изучения последствий на окружающую среду в течение всего жизненного цикла, от добычи сырья до обработки, перехода к распределению продукции, к ее установке и обслуживанию, вплоть до демонтажа с рекуперацией и утилизацией. Полученные результаты, в особенности на основе первичных данных компании, а не только общих баз данных, были проверены и опубликованы в ЭДП (ЭКОЛОГИЧЕСКАЯ ДЕКЛАРАЦИЯ ПРОДУКЦИИ), что гарантирует обмен прозрачной информацией с потребителями. ЭДП способствует получению кредитов LEED.

УПРАВЛЕНИЕ КАРЬЕРАМИ - Защита окружающей среды в Emilgroup начинается с выбора поставщиков сырья, которое поступает только с официальных карьеров, имеющих план рекультивации, соответствующий международным природоохранным нормам. Внутренняя рекуперация использованных в производственном процессе материалов позволяет Emilgroup снизить добычу сырья и объем перевозок на производственные предприятия.

СОДЕРЖАНИЕ ВТОРСЫРЬЯ - В свете построения круговой экономики Emilgroup повторно использует в большинстве своей продукции производственные отходы, поступающие с других керамических предприятий в этом кластере и выбирает сырье, содержащее определенное количество вторсырья. Процент содержания вторсырья в продукции учитывается в кредитах LEED.

EDILIZIA SOSTENIBILE

HPD

Emilgroup realizza i propri prodotti utilizzando materie prime di origine naturale, come argille, feldspati, sabbie e pigmenti inorganici. Per garantire la trasparenza delle informazioni, l'Azienda pubblica dal 2016 l'HPD (Health Product Declaration), un'autodichiarazione sulla composizione chimica del prodotto, che permette all'utilizzatore di verificare il grado e la tipologia di pericolosità associata ai singoli componenti dei prodotti da costruzione.

L'HPD viene riconosciuta all'interno dei crediti LEED.



GREENGUARD e GREENGUARD GOLD

La salubrità degli ambienti in cui viviamo e lavoriamo è fondamentale. Emilgroup realizza prodotti sicuri, come certificato dal rigoroso standard americano Greenguard, che garantisce il rispetto di bassissimi livelli di emissione di sostanze organiche volatili (VOC), e dal Greenguard Gold, con limiti più stringenti per gli ambienti sensibili, come le scuole. I marchi Greenguard e Greenguard Gold contribuiscono ai crediti LEED.

SUSTAINABLE CONSTRUCTION

HPD - Emilgroup develops its products using raw materials of natural origin like clays, feldspars, sands and inorganic pigments. To guarantee the transparency of its information, since 2016 the company has published an HPD (Health Product Declaration), a self-declaration on the chemical composition of the product which enables users to verify the level and type of danger associated with the individual components of construction products.

The HPD is recognised by LEED credits.

GREENGUARD and GREENGUARD GOLD - The healthiness of the environments in which we live and work is of the utmost importance. Emilgroup develops safe products, as certified by the stringent American Greenguard standard, which guarantees respect for very low emissions of volatile organic compounds (VOC), and by Greenguard Gold, with more restrictive limits for sensitive environments, like schools. The Greenguard and Greenguard Gold brands contribute to LEED credits.

CONSTRUCTION DURABLE

HPD - Emilgroup fabrique ses produits en utilisant des matières premières d'origine naturelle, telles que des argiles, des feldspaths, des sables et des pigments inorganiques. Pour assurer la transparence des informations, l'entreprise publie depuis 2016 la HPD (Health Product Declaration), ou Fiche de déclaration sanitaire du produit, une auto-déclaration relative à la composition chimique du produit, qui permet à l'utilisateur de vérifier le degré et le type de danger associé aux différents composants des produits de construction.

L'HPD est reconnue dans les crédits LEED.

GREENGUARD et GREENGUARD GOLD - La salubrité des environnements dans lesquels nous vivons et travaillons est fondamentale. Emilgroup fabrique des produits sûrs, certifiés par les normes américaines rigoureuses de Greenguard, qui garantit le respect de très faibles niveaux d'émissions de composés organiques volatils (COV), et par Greenguard Gold, dont les limites sont plus strictes pour les environnements sensibles, comme les écoles. Les labels Greenguard et Greenguard Gold contribuent à l'obtention de crédits LEED.

NACHHALTIGES BAUEN

HPD - Emilgroup verwendet für die Herstellung ihrer Produkte Rohstoffe natürlichen Ursprungs wie Ton, Feldspat, Sand und anorganische Pigmente. Zur Gewährleistung der Transparenz der Informationen veröffentlicht das Unternehmen seit 2016 eine HPD-Deklaration (Health Product Declaration). Es handelt sich um eine Eigenerklärung zur chemischen Zusammensetzung des Produkts, anhand der der Verbraucher das Ausmaß und die Art der gesundheitlichen Auswirkungen im Zusammenhang mit den Inhaltsstoffen der Bauprodukte prüfen kann.

Die HPD wird bei der Vergabe von LEED-Punkten berücksichtigt.

GREENGUARD und GREENGUARD GOLD - Ein gesundes Raumklima am Arbeitsplatz und Zuhause ist grundlegend. Emilgroup fertigt sichere Produkte, die nach dem strengen amerikanischen Greenguard-Standard für die Einhaltung niedriger Emissionen von flüchtigen organischen Verbindungen (VOC) oder nach dem Greenguard Gold-Standard zertifiziert sind, der noch schärfere Grenzwerte für besonders sensible Umgebungen wie Schulen festlegt. Die Marken Greenguard und Greenguard Gold tragen zur Erlangung von LEED-Punkten bei.

CONSTRUCCIÓN SOSTENIBLE

HPD - Emilgroup realiza sus propios productos utilizando materias primas de origen natural, como arcillas, feldespatos, arenas y pigmentos inorgánicos. Para garantizar la máxima transparencia informativa, la empresa desde 2016 publica la HPD (Health Product Declaration), una autodeclaración relativa a la composición química del producto, gracias a la cual el usuario puede conocer el grado y el tipo de peligrosidad correspondiente a los varios componentes de los productos de construcción.

La HPD contribuye a la obtención de créditos LEED.

GREENGUARD y GREENGUARD GOLD - La salubridad de los ámbitos en que vivimos y trabajamos es fundamental. Emilgroup fabrica productos seguros, según certifica el riguroso estándar estadounidense Greenguard, que garantiza la observación de muy bajos niveles de emisión de compuestos orgánicos volátiles (COV), y el Greenguard Gold, con límites más severos en referencia a ámbitos más sensibles, como las escuelas. Las marcas Greenguard y Greenguard Gold contribuyen a la consecución de créditos LEED.

ЭКОЛОГИЧЕСКИ-РАЦИОНАЛЬНОЕ СТРОИТЕЛЬСТВО

ДБПЗ - Emilgroup производит свою продукцию с использованием натурального сырья, такого как глина, полевые шпаты, песок и неорганические пигменты. Для обеспечения прозрачности информации с 2016 года компания публикует ДБПЗ (Декларация о безопасности продукции для здоровья) - декларацию компании о химическом составе продукции, позволяющую пользователю проверить степень и тип опасности, связанной с каждым отдельным строительным материалом.

ДБПЗ учитывается в кредитах LEED.

GREENGUARD и GREENGUARD GOLD - Безопасность для здоровья помещений, в которых мы живем и работаем, имеет фундаментально важное значение. Emilgroup производит безопасную продукцию, что сертифицируется строгим американским стандартом Greenguard, гарантирующим соблюдение очень низких уровней выделений летучих органических соединений (ЛОС), и Greenguard Gold с еще более жесткими ограничениями для чувствительных помещений, таких как школы. Клейма Greenguard и Greenguard Gold учитываются в кредитах LEED.

EDILIZIA SOSTENIBILE

IMBALLAGGI RICICLABILI

Dal 2000 Emilgroup impiega materiali completamente riciclabili per imballaggi, carta, fustelle, plastica dei cappucci e palette in legno.

1

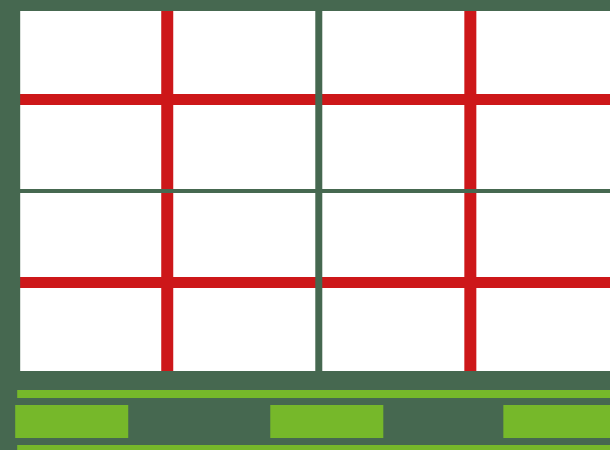

2



3



**CONSORZI ITALIANI
PER LA RACCOLTA,
RECUPERO E RICICLAGGIO
DEGLI IMBALLAGGI**

ITALIAN PACKAGING COLLECTION,
RECOVERY AND RECYCLING CONSORTIA

RILEGNO
www.rilegno.it

Conorzio nazionale per la raccolta, il recupero ed il riciclaggio degli imballaggi in legno.
National wooden packaging collection, recovery and recycling consortium.

COREPLA
www.corepla.it

Conorzio nazionale per la raccolta, il recupero ed il riciclaggio degli imballaggi in plastica.
National plastic packaging collection, recovery and recycling consortium.

COMIECO
www.comieco.it

Conorzio nazionale per la raccolta, il recupero ed il riciclaggio degli imballaggi a base cellulosica.
National cellulose-based packaging collection, recovery and recycling consortium.

PLASTICA
PLASTIC



CAPPUCCI > Imballaggi in plastica > CER 150102
Hoods Plastic packaging EWC 150102

PLASTICA
PLASTIC



REGGETTE > Imballaggi in plastica > CER 150102
Straps Plastic packaging EWC 150102

LEGNO
WOOD



PALLETS > Imballaggi in legno > CER 150103
Pallets Wooden packaging EWC 150103

CARTA - CARTONE
PAPER - CARDBOARD



SCATOLA > Imballaggi carta e cartone > CER 150101
Boxes Paper and cardboard packaging EWC 150101

INERTE
AGGREGATES



PIASTRELLE > ScaScarti di piastrelle non posate > CER 170103
Tiles Waste from unlaidd tiles EWC 170103

INERTE
AGGREGATES



PIASTRELLE/MOSAICI > Miscugli di cemento e piastrelle > CER 170107
Tiles and Mosaics Mixtures of concrete and tiles EWC 170107

Emilceramica è iscritta al CONAI (Conorzio Nazionale Imballaggi) CODICE SOCIO 11001608 in quanto utilizzatore di imballi.
Emilceramica aderisce al Sistema PARI (Piano per la gestione autonoma dei rifiuti di imballaggio) del CARPI (Conorzio autonomo riciclo plastiche Italia).

Emilceramica is member number 11001608 of the CONAI (National Packaging Consortium) as a user of packaging.
Emilceramica is also a member of the PARI System (Independent packaging waste management plan) of the CARPI (Italian independent plastic recycling consortium).

PERSONE E TERRITORIO

SOSTEGNO ALLA CULTURA

Emilgroup crede nel ruolo sociale e culturale dell'impresa ed ha promosso e finanziato, negli anni, rilevanti opere di promozione e di salvaguardia del patrimonio culturale.

Emilgroup si è impegnata a lungo per il restauro del Palazzo Ducale di Sassuolo, recuperando e ripristinando le originali pavimentazioni in cotto, finanziando il restauro degli affreschi seicenteschi del pittore Jean Boulanger nella "camera di Giove".

Tra le numerose iniziative si segnalano per importanza ed originalità la riscoperta delle antiche origini della ceramica di Sassuolo, sostenuta e documentata con la pubblicazione di fondamentali opere editoriali, tra cui spiccano i volumi sulla ceramica sassolese del '700 e '800.

SOSTEGNO ALLA SCUOLA

Dal 2008, il gruppo conferisce annualmente 10 borse di studio per complessivi 10.000 euro, destinate ai figli dei dipendenti che si sono dimostrati più meritevoli nello studio.

L'iniziativa è frutto di un accordo con i rappresentanti dei lavoratori, a supporto delle carriere scolastiche di successo e nell'ottica di consolidare i traguardi raggiunti. I premi vengono consegnati nel periodo autunnale in presenza delle istituzioni e dei famigliari.

PEOPLE AND THE COMMUNITY

SUPPORT FOR CULTURE - Emilgroup believes in the social and cultural role of enterprise and has promoted and financed important projects to promote and safeguard cultural heritage over the years.

Emilgroup has made a long-term commitment to the restoration of the Ducal Palace in Sassuolo, recovering and restoring the original floors in terracotta and financing the restoration of the 17th-century frescoes by painter Jean Boulanger in the "Camera di Giove" (Jupiter Room). Among the many initiatives, the most important and original include the rediscovery of the ancient origins of Sassuolo ceramics, supported and documented with the publication of fundamental works, including volumes on Sassuolo ceramics from the 18th and 19th centuries.

SUPPORT FOR SCHOOLS - Since 2008, every year the group has awarded 10 student grants of a total of €10,000 to children of its employees who have shown outstanding ability in their studies. This initiative is the result of an agreement with the workers' representatives and aims to support successful academic careers and consolidate the achievements of the students. The grants are awarded in the autumn in the presence of the authorities and the students' families.

POPULATION ET TERRITOIRE

SOUTIEN À LA CULTURE - Emilgroup croit au rôle social et culturel de l'entreprise. À ce titre, au cours des ans, il a promu et financé d'importantes actions de promotion et de sauvegarde du patrimoine culturel.

Emilgroup s'est longuement investi dans la restauration du Palais ducal de Sassuolo. L'entreprise a récupéré et remis en état les dallages originaux en terre cuite et financé la restauration des fresques du XVIIe siècle du peintre Jean Boulanger dans la « Camera di Giove » (Chambre de Jupiter).

Parmi les nombreuses initiatives mises en œuvre par le Groupe, l'une est particulièrement importante et originale : il s'agit de la redécouverte des origines antiques de la céramique de Sassuolo, étayée et documentée par la publication d'ouvrages fondamentaux, dont les livres sur la céramique de Sassuolo du XVIIIe et XIXe et siècle.

SOUTIEN À L'ÉDUCATION - Depuis 2008, le Groupe attribue chaque année 10 bourses d'étude pour un montant global de 10 000 euros, destinées aux enfants les plus méritants de salariés. Fruit d'un accord avec les représentants des salariés, cette initiative soutient la réussite scolaire, dans un optique de consolidation des résultats obtenus. Ces prix sont remis en automne en présence des institutions et des familles.

MENSCHEN UND REGION

UNTERSTÜTZUNG IM BEREICH KULTUR - Emilgroup glaubt an die soziale und kulturelle Aufgabe von Unternehmen und hat im Laufe der Jahre wichtige Maßnahmen zur Förderung und zum Schutz des Kulturerbes unterstützt und finanziert.

Emilgroup engagierte sich lange Zeit für die Restaurierung des Palazzo Ducale in Sassuolo, wo die ursprünglichen Cotto-Bodenbeläge wiederhergestellt wurden, und hat die Restaurierung der aus dem 17. Jahrhundert stammenden Fresken des Malers Jean Boulanger im „Camera di Giove“ (Jupiter-Zimmer) finanziert.

Unter den zahlreichen Initiativen ist aufgrund ihrer Bedeutung und Originalität vor allem die Wiederentdeckung der historischen Ursprünge der Keramik in Sassuolo zu nennen, die durch die Veröffentlichung grundlegender Verlagswerke, darunter die Bände über die Keramik in Sassuolo im 18. und 19. Jahrhundert, unterstützt und dokumentiert wurde.

UNTERSTÜTZUNG IM BEREICH SCHULE - Seit 2008 vergibt die Gruppe jährlich 10 Stipendien in einer Höhe von insgesamt 10.000 € an besonders begabte Kinder von Mitarbeitern. Die Initiative ist das Ergebnis einer Vereinbarung mit Arbeitnehmervertretern zur Unterstützung und Förderung guter Schüler. Die Stipendien werden im Herbst im Beisein von Vertretern der Institutionen und Familienangehörigen vergeben.

PERSONAS Y TERRITORIO

APOYO A LA CULTURA - Emilgroup cree en el papel social y cultural de la empresa, por lo que a lo largo de los años ha promovido y financiado importantes obras de promoción y salvaguardia del patrimonio cultural.

Emilgroup se ha comprometido durante mucho tiempo en la restauración del Palazzo Ducale de Sassuolo, recuperando y restaurando los pavimentos de terracota originales, financiando la restauración de los frescos del pintor Jean Boulanger del siglo XVII en la "Camera di Giove" (Sala de Júpiter).

Entre las numerosas iniciativas, se indican por importancia y originalidad el redescubrimiento de los antiguos orígenes de la cerámica en Sassuolo, apoyado y documentado con la publicación de obras editoriales fundamentales, entre las cuales se destacan los volúmenes sobre la cerámica de Sassuolo de los siglos XVIII y XIX.

APOYO A LA ESCUELA - Desde 2008, el grupo otorga diez becas formativas al año, por un valor total de diez mil euros, destinadas a los hijos de los empleados que hayan demostrado una mayor aplicación en el estudio. La iniciativa es el resultado de un acuerdo con los representantes de los trabajadores, con el fin de apoyar las trayectorias escolares exitosas y con el objetivo de consolidar los logros obtenidos. Los premios se entregan en otoño ante instituciones y familiares.

ЛЮДИ И ТЕРРИТОРИЯ

ПОДДЕРЖКА КУЛЬТУРЫ - Emilgroup верит в социальную и культурную роль предпринимательства и в течение прошлых лет организовала и профинансировала важные мероприятия по продвижению и защите культурного наследия.

Emilgroup долго участвовала в реставрации Герцогского Дворца в Сассуоло, отреставрировав и восстановив оригинальные полы из неглазурованной керамики, профинансировав реставрацию фресок XVII в. кисти Жана Булангера в «комнате Юпитера».

Среди многочисленных инициатив следует упомянуть важный и оригинальный проект, связанный с открытием истоков производства керамики в Сассуоло, который получил поддержку и был задокументирован публикацией фундаментальных работ, среди которых - тома о керамике в Сассуоло в XVII и XIX вв.

ПОДДЕРЖКА ШКОЛЫ - С 2008 года наша группа ежегодно присуждает 10 стипендий на общую сумму 10000 евро для детей сотрудников, которые показали самые высокие результаты в учебе. Эта инициатива является результатом соглашения с представителями работников о поддержке успешного обучения в школе и об укреплении достигнутых целей. Стипендии вручаются осенью, в присутствии представителей госорганов и членов семей.

PERSONE E TERRITORIO

SOSTEGNO AI LAVORATORI E ALLE LORO FAMIGLIE

Emilceramica ha creato un esteso programma di welfare aziendale, volto a incrementare il benessere individuale e familiare dei lavoratori dipendenti, che possono usufruire di una serie di servizi a tariffe agevolate erogati da alcuni esercizi convenzionati presenti sul nostro territorio (banche e assicurazioni, autovetture e servizi, farmacia e servizi per la salute, servizi alla famiglia, servizi per la casa, librerie, associazioni sportive e palestre, ristorazione, trasporti e viaggi, corsi di lingua, ristoranti e supermercati).

Inoltre, l'azienda offre un piano di assistenza sanitaria per i dipendenti e le loro famiglie, consulenza Legale, consulenza Psicologica e servizi di Assicurazione. Tutte le prestazioni effettuate in convezione sono svolte da professionisti specializzati nel pieno rispetto della privacy dei dipendenti.

Dal 2017, in collaborazione con AUSL di Modena, medico del lavoro e rappresentanze sindacali, Emilceramica aderisce al progetto VISION 2020 per sensibilizzare i dipendenti sui temi della salute e del benessere attraverso uno stile di vita sano e corretto con incontri dedicati e il supporto del medico aziendale durante le visite periodiche (lotta contro il fumo, prevenzione di obesità e malattie cardio vascolari, prevenzione dermatologica, incontri con nutrizionista e osteopata, interventi di primo soccorso e disostruzione pediatrica).

PEOPLE AND THE COMMUNITY

SUPPORT FOR WORKERS AND THEIR FAMILIES - Emilceramica has put together an extensive company welfare programme aimed at improving the individual and family wellbeing of employees who can take advantage of a series of services provided by a number of local partners (banks and insurance companies, cars and services, pharmacies and health services, family services, services for the home, bookshops, sports clubs and gyms, catering, transport and travel, language courses, restaurants and supermarkets) at favourable rates. The company also offers a healthcare programme for employees and their families, legal advice, psychological health assistance and insurance services. All services offered under these schemes are provided by specialist professionals with the confidentiality of employees guaranteed. Since 2017, in association with the Modena Health Trust, the company physician and the union representatives, Emilceramica has adhered to the VISION 2020 project to raise awareness among employees of the issues of health and wellbeing through healthy and appropriate lifestyles with dedicated meetings and the support of the company physician during periodic check-ups (combating smoking, preventing obesity and cardiovascular illnesses, dermatological prevention, meetings with nutritionists and osteopaths, first aid and child choking training).

POPULATION ET TERRITOIRE

SOUTIEN AUX TRAVAILLEURS ET À LEUR FAMILLE - Emilceramica a créé un grand programme d'avantages sociaux et culturels en entreprise, destiné à accroître le bien-être individuel et familial des salariés. C'est ainsi qu'ils peuvent bénéficier d'une série de services à des tarifs préférentiel fournis par des entreprises conventionnées présentes sur notre territoire (banques et compagnies d'assurance, voitures et services, pharmacie et services de santé, services aux familles, services à domicile, librairies, associations sportives et salles de sport, restauration, transports et voyages, cours de langues, restaurants et supermarchés). En outre, l'entreprise propose un plan de soins de santé pour les salariés et leur famille, des consultations juridiques, des consultations psychologiques et des services d'assurance. Toutes les prestations dans le cadre de la convention sont effectuées par des professionnels spécialisés, dans le plein respect de la protection de la vie privée des salariés. Depuis 2017, en collaboration avec l'Agence Unité sanitaire de Modène, la médecine du travail et les représentants syndicaux, Emilceramica adhère au projet VISION 2020. Son objectif : sensibiliser les salariés aux questions de santé et de bien-être à travers un mode de vie sain et équilibré, dans le cadre de réunions dédiées et le soutien du médecin d'entreprise lors des visites périodiques (lutte contre le tabagisme, prévention de l'obésité et des maladies cardiovasculaires, prévention dermatologique, entretiens avec un nutritionniste et un ostéopathe, premiers secours et interventions de désobstruction des voies respiratoires chez l'enfant).

MENSCHEN UND REGION

UNTERSTÜTZUNG IM BEREICH MITARBEITER UND IHRE FAMILIEN - Emilceramica bietet ein umfangreiches Programm an betrieblichen Sozialleistungen, um das individuelle und familiäre Wohlbefinden der Mitarbeiter zu steigern. Diese können bestimmte Dienste zu ermäßigten Preisen in Anspruch nehmen, die über vertragsgebundene Betriebe in der Region erbracht werden (Banken und Versicherungen, Pkws und Services, Apotheken und Gesundheitsdienste, Familiendienste, Hausdienste, Buchhandlungen, Sportvereine und Fitness-Studios, Gastronomiebetriebe, Verkehr und Reisen, Sprachkurse, Restaurants und Supermärkte). Außerdem bietet das Unternehmen einen Gesundheitsvorsorgeplan für die Mitarbeiter und ihre Familien, Rechtsberatung, psychologische Beratung und Versicherungsdienste. Alle vertragsgebundenen Leistungen werden von Fachpersonal stets unter gebührender Wahrung der Privatsphäre der Mitarbeiter ausgeführt. Seit 2017 nimmt Emilceramica in Zusammenarbeit mit dem örtlichen Gesundheitsamt (AUSL) von Modena, dem Betriebsarzt und Gewerkschaftsvertretern am Projekt VISION 2020 teil, um ihre Mitarbeiter zu Themen wie Gesundheit und Wohlbefinden durch einen gesunden und korrekten Lebensstil zu sensibilisieren. Dies erfolgt durch spezielle Begegnungen und mit Unterstützung des Betriebsarztes im Rahmen von regelmäßigen ärztlichen Untersuchungen (Kampf gegen Tabakkonsum, Vorbeugung von Fettleibigkeit und Herz-Kreislauf-Erkrankungen, dermatologische Vorbeugung, Begegnungen mit Ernährungsexperten und Osteopathen, Erste-Hilfe-Maßnahmen und Maßnahmen zur Befreiung der Atemwege von Kindern).

PERSONAS Y TERRITORIO

APOYO A LOS TRABAJADORES Y A SUS FAMILIAS - Emilceramica ha creado un extenso programa de bienestar en la empresa, orientado a incrementar el bienestar individual y familiar de los empleados y trabajadores, que pueden disfrutar de una serie de servicios a precios módicos prestados por establecimientos asociados presentes en nuestro territorio (bancos y corredurías de seguros, concesionarios de automóviles y talleres de asistencia técnica, farmacias y servicios en beneficio de la salud, servicios a la familia, servicios para el hogar, librerías, asociaciones deportivas y gimnasios, restauración, transportes y viajes, cursos de idiomas, restaurantes y supermercados). Además, la empresa ofrece un plan de asistencia sanitaria para los trabajadores y sus familias, asesoramiento legal, asesoramiento psicológico y servicios de seguros. Todos los servicios a los que se acceda mediante estos convenios son prestados por profesionales especializados y respetando plenamente la privacidad del empleado. Desde 2017, en colaboración con los servicios sanitarios públicos AUSL de Módena, el médico del trabajo y los representantes sindicales, Emilceramica se suma al proyecto VISION 2020 para sensibilizar a los trabajadores acerca del cuidado de la salud y el bienestar a través de un estilo de vida sano y correcto con encuentros específicos y el apoyo del médico de la empresa durante las visitas periódicas (lucha contra el tabaco, prevención de la obesidad y de enfermedades cardiovasculares, prevención dermatológica, encuentros con nutricionistas y osteópatas, intervenciones de primeros auxilios y desobstrucción de la vía aérea en pediatría).

ЛЮДИ И ТЕРРИТОРИЯ

ПОДДЕРЖКА РАБОТНИКОВ И ИХ СЕМЕЙ - Emilceramica разработала обширную программу корпоративного соцобеспечения, нацеленную на повышение индивидуального и семейного уровня жизни работников и сотрудников, которые могут воспользоваться рядом услуг по льготным тарифам, предоставляемых некоторыми ассоциированными заведениями, имеющимися на нашей территории (банки и страховые агентства, автосалоны и услуги, аптеки и услуги для здоровья, услуги для семей, услуги для дома, книжные магазины, спортивные ассоциации и спортзалы, общественное питание, транспорт и путешествия, языковые курсы, рестораны и супермаркеты). Кроме того, компания предлагает план медицинской помощи сотрудникам и членам их семей, юридические консультации, психологическую помощь и страховые услуги. Все услуги, предоставляемые на основе договоренностей, оказываются квалифицированными специалистами, при полном соблюдении конфиденциальности сотрудников. С 2017 г. в сотрудничестве со Здравоохранительным предприятием Модены, врачом производственной медицины и представителями профсоюзов, Emilceramica участвует в проекте VISION 2020 по повышению ответственности сотрудников в вопросах здоровья и хорошего самочувствия посредством ведения здорового образа жизни. Для этого организуются специальные встречи и обеспечивается поддержка со стороны врача компании во время периодических медосмотров (борьба с курением, профилактика ожирения и сердечно-сосудистых заболеваний, дерматологическая профилактика, встречи с диетологом и остеопатом, первая помощь и очистка дыхательных путей в педиатрии).

20TWENTY



PRODUCT CERTIFIED FOR LOW CHEMICAL EMISSIONS:
ULCDM/CG
UL 2818

FORMATI

Sizes | Formats | Formate | Tamaños | Форматы

10,5 mm.

22,5x180 - 8^{7/8}"x70^{7/8}" Naturale

9,5 mm.

25x150 - 9^{13/16}"x59^{1/6}" Naturale

20x120 - 7^{7/8}"x47^{1/4}" Naturale

20x20 - 7^{7/8}"x7^{7/8}" Naturale

SUPERFICI

Finishes | Finitions | Oberflächen
Superficies | Отделка поверхности

NATURALE

R10 DIN 51130

B (A+B) DIN 51097

Wet \geq 0,50 DCOF

\geq 0,40 B.C.R.A.

P3 Pendolo AS 4586

> 36 Low Slip potential Pendolo BS 7976

2 Pendolo UNE 41901

SHADE VARIATIONS



V3 HIGH



Vintage



V4 RANDOM

DESTINAZIONI D'USO

Intended uses | Domaines d'application
Zweckbestimmung | Usos previstos | Назначение



22% 22,5x180
12% 20x120
5% 25x150
0% 20x20



UPEC-D+



PALLETS WHITE



INDUSTRIAL



TRONCO

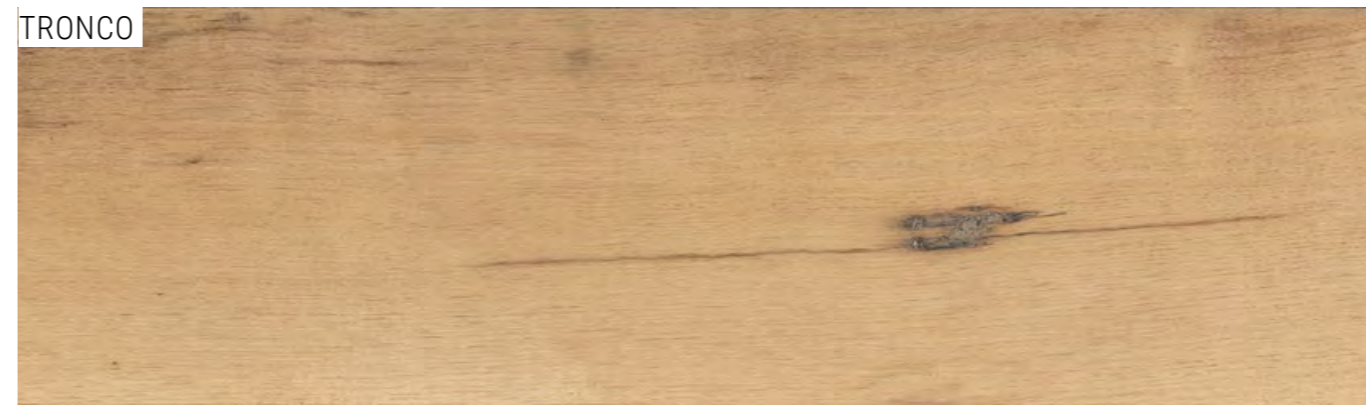

TAVOLA



VINTAGE



COLORI E FORMATI

Colours and Sizes | Couleurs et Formats | Farben und Formate | Colores y Tamaños | Цвета и Форматы

Pallets White



Industrial



Tronco



Tavola



Vintage

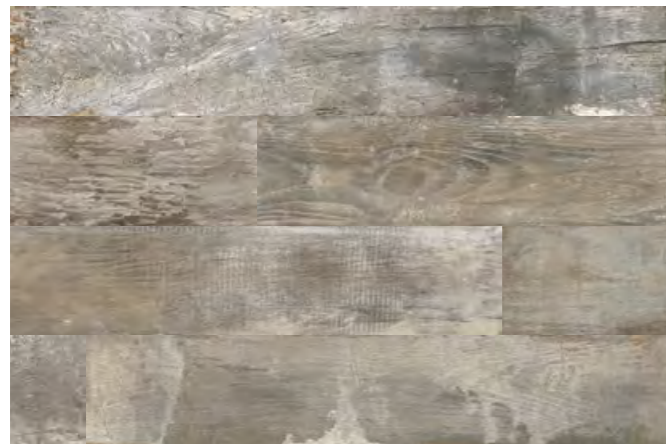

Si consiglia la posa con fuga 2 mm. - Laying with a 2 mm-joint is recommended. - Pose recommandée avec joints de 2 mm.
Es wird eine Fugenbreite von 2 mm empfohlen. - Se recomienda la colocación con juntas de 2 mm. - Рекомендуется укладка с швом 2 мм.

COLORI E FORMATI

Colours and Sizes | Couleurs et Formats | Farben und Formate | Colores y Tamaños | Цвета и Форматы

10,5 mm.

Naturale Rett.
22,5x180 - 8^{7/8}x70^{7/8}"

EGEW Industrial ● **T52**
EGEX Tronco ● **T52**

9,5 mm.

Naturale Rett.
25x150 - 9^{13/16}x59^{1/6}"

ECY0 Industrial U₄P₂E₃C₂D₄ ● **T38**
ECY1 Tronco ● **T38**

Naturale Rett.
20x120 - 7^{7/8}x47^{1/4}"

ECJT Pallets White ● **T23**
ECJU Industrial U₄P₂E₃C₂D₄ ● **T23**
ECJV Tronco ● **T23**
ECJW Tavola ● **T23**
ECJX Vintage ● **T23**







Naturale
20x20 - 7^{7/8}x7^{7/8}"

ECTM Industrial ● **T12**
ECTN Tronco ● **T12**

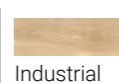
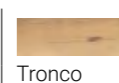
Verificare l'abbinamento dei toni tra i formati differenti. - Check the colour matching between different sizes.
Vérifier l'assortiment des tonalités entre les différents formats. - Die Kombination der Farbtöne unter den verschiedenen Formaten prüfen.
Comprobar la combinación de los tonos entre los distintos formatos. - Проверьте сочетание тонов у разных форматов.

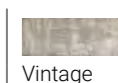
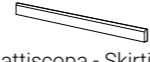
PEZZI SPECIALI

Trims | Peces Speciales | Formteile | Piezas Especiales | Специальные Изделия

	Dimensione Size	 Pallets White	 Industrial	 Tronco	 Tavola	 Vintage	Fascia di prezzo Price band
 Battiscopa - Skirting	Nat. Rett. 4,6x120 - 1 ^{13/16} x47 ^{1/4} " Pcs. Box. 6 - LM x Box 7,20	ECN7	ECN8	ECN9	ECNA	ECNC	● A28
 Gradino - Stair Tread	Nat. Rett. 33x120 - 12 ^{15/16} x47 ^{1/4} " Pcs. Box. 2 - LM x Box 2,40	ECPA	ECPC	ECPD	ECPE	ECPF	● A82
 Gradone - Step	Nat. Rett. 33x120x3,2x3,2 12 ^{15/16} x47 ^{1/4} x1 ^{1/4} x1 ^{1/4} " Pcs. Box. 2 - LM x Box 2,40	ECND	ECNE	ECNF	ECNG	ECNH	● A98
 Angolare Dx Sx Corner Tile Dx Sx	Nat. Rett. 33x120x3,2x3,2 12 ^{15/16} x47 ^{1/4} x1 ^{1/4} x1 ^{1/4} " Pcs. Box. 1 - LM x Box 1,20	DX ECMX	DX ECMZ	DX ECN1	DX ECN3	DX ECN5	● A104
		SX ECMY	SX ECN0	SX ECN2	SX ECN4	SX ECN6	

IMBALLI E PESI

Packing and Weight | Emballages et Poids | Verpackung und Gewicht | Embalajes y Pesos | Упаковка и Вес

Formato Size Format Format Tamaño Формат cm	Spessore Thickness Epaisseur Stärke Espesor Толщина mm	Pz. x Mq. Pieces x Sqm Pcs / M ² Stk. x Qm Pzs x Mc. Шт x Кв.М.	Pz. x Scat. Pieces x Box Pcs / Bte Stk. x Krt. Pzs x Caja Шт x Кор.	Mq. x Scat. Sqm x Box M ² / Bte Qm x Krt. Mc. x Caja Кв.М. x Кор.	Peso x Scat. Weight x Box Poids / Bte Gewicht x Krt. Peso x Caja Вес x Кор. Kg	Scat. x Pal. Boxes x Pal. Bte / Pal. Krt. x Pal. Cajas x Pal. Кор. x Подд.	Mq. x Pal. Sqm x Pal. M ² / Pal. Qm x Pal. Mc. x Pal. Кв.М x Подд.	Peso x Pal. Weight x Pal. Poids / Pal. Gewicht x Pal. Peso x Pal. Вес x Подд. Kg
22,5x180 Naturale	10,5	2,47	4	1,62	38,88	36	58,32	1400
25x150 Naturale	9,5	2,67	3	1,13	24,75	45	50,63	1114
20x120 Naturale	9,5	4,17	4	0,96	21,12	40	38,40	845
20x20 Naturale	9,5	25,00	24	0,96	21,12	54	51,84	1140

ANTHOLOGY STONE



PRODUCT CERTIFIED FOR LOW CHEMICAL EMISSIONS:
ULCDM/CG
UL 2818

FORMATI

Sizes | Formats | Formate | Tamaños | Форматы

9,5 mm.

30x60 - 11^{13/16}"x23^{5/8}" Indoor Nat. - Outdoor Nat.

SUPERFICI

Finishes | Finitions | Oberflächen
Superficies | Отделка поверхности

INDOOR NATURALE

R10 DIN 51130

B (A+B) DIN 51097

Wet $\geq 0,50$ DCOF

$\geq 0,40$ B.C.R.A.

P3 Pendolo AS 4586

> 36 Low Slip potential Pendolo BS 7976

- Pendolo UNE 41901

OUTDOOR NATURALE

R11 DIN 51130

C (A+B+C) DIN 51097

Wet $\geq 0,65$ DCOF

$\geq 0,40$ B.C.R.A.

P3 Pendolo AS 4586

> 36 Low Slip potential Pendolo BS 7976

- Pendolo UNE 41901

SHADE VARIATIONS



V4 RANDOM

DESTINAZIONI D'USO

Intended uses | Domaines d'application
Zweckbestimmung | Usos previstos | Назначение



12%



GOLD



GREY



DARK GREY

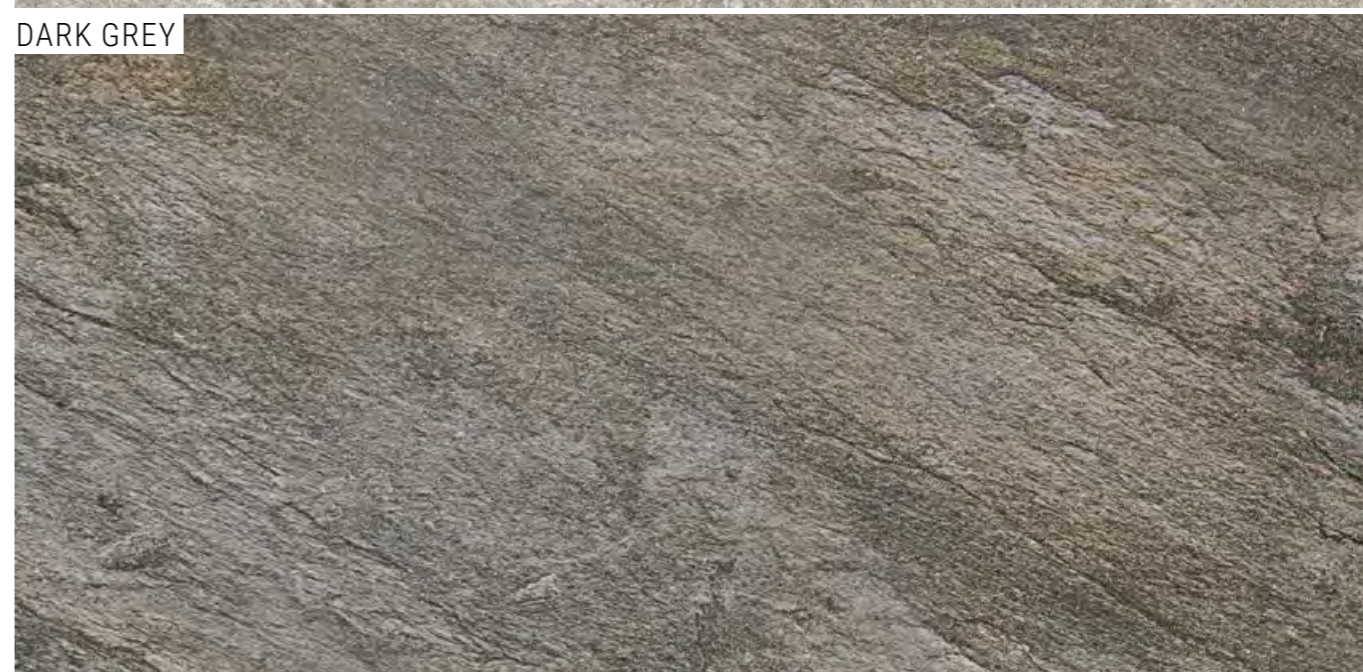

ANTHOLOGY STONE

COLORI E FORMATI

Colours and Sizes | Couleurs et Formats | Farben und Formate | Colores y Tamaños | Цвета и Форматы

Gold



Grey



Dark Grey



ANTHOLOGY STONE

COLORI E FORMATI

Colours and Sizes | Couleurs et Formats | Farben und Formate | Colores y Tamaños | Цвета и Форматы

 **9,5 mm.**

	Indoor Nat. Rett.		Outdoor Nat. Rett.	
	30x60 - 11 ^{13/16} "x23 ^{5/8} "		30x60 - 11 ^{13/16} "x23 ^{5/8} "	
	E1F1 Gold	● T10	E1FR Gold	● T10
E1F2 Grey	● T10	E1FS Grey	● T10	
E1F3 Dark Grey	● T10	E1FT Dark Grey	● T10	

Si consiglia la posa con fuga 2 mm. - Laying with a 2 mm-joint is recommended. - Pose recommandée avec joints de 2 mm.
 Es wird eine Fugenbreite von 2 mm empfohlen. - Se recomienda la colocación con juntas de 2 mm. - Рекомендуется укладка с швом 2 мм.

ANTHOLOGY STONE

DECORI

Decors | Decors | Dekore | Decorados | Декоры

MOSAICO*

Tessera - Chip 2,8x2,8 - 1¹/₈"x1¹/₈"



30x30 - 11¹³/₁₆"x11¹³/₁₆"

E1GZ Gold Indoor Nat. ● **A96**



30x30 - 11¹³/₁₆"x11¹³/₁₆"

E1H0 Grey Indoor Nat. ● **A96**

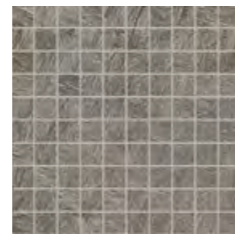

30x30 - 11¹³/₁₆"x11¹³/₁₆"

E1H1 Dark Grey Indoor Nat. ● **A96**

LISTELLI SFALSATI*



30x60 - 11¹³/₁₆"x23⁵/₈"

E1H5 Gold Indoor Nat. ● **A80**



30x60 - 11¹³/₁₆"x23⁵/₈"

E1H8 Grey Indoor Nat. ● **A80**

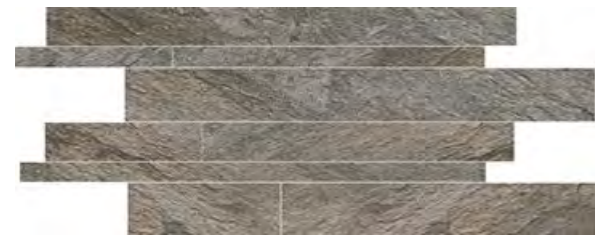

30x60 - 11¹³/₁₆"x23⁵/₈"

E1HC Dark Grey Indoor Nat. ● **A80**

ANTHOLOGY STONE

PEZZI SPECIALI

Trims | Pieces Speciales | Formteile | Piezas Especiales | Специальные Изделия

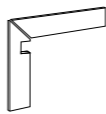
	Dimensione Size				Fascia di prezzo Price band			
 Battiscopa - Skirting	Indoor Nat. Rett. 7x60 - 2 ³ / ₄ "x23 ⁵ / ₈ " Pcs. Box 15 - LM x Box 9,00	E1QF	E1QG	E1QH	● A11			
 Elemento A "L" L Shaped Piece	Outdoor Nat. Rett. 15x30x4,5 5 ⁷ / ₈ "x11 ¹³ / ₁₆ "x1 ³ / ₄ " Pcs. Box 6 - LM x Box 1,80	E1HP	E1HQ	E809	● A19			
 Gradone - Step	Indoor Nat. Rett. 30x60x3,2x3,2 11 ¹³ / ₁₆ "x23 ⁵ / ₈ "x1 ¹ / ₄ "x1 ¹ / ₄ " Pcs. Box 4 - LM x Box 2,40	E8LQ	E8LS	E8LU	● A58			
	Outdoor Nat. Rett. 30x60x3,2x3,2 11 ¹³ / ₁₆ "x23 ⁵ / ₈ "x1 ¹ / ₄ "x1 ¹ / ₄ " Pcs. Box 4 - LM x Box 2,40	E8LR	E8LT	E8LV	● A58			
 Angolare - Corner Tile	Indoor Nat. Rett. 30x30x3,2x3,2 11 ¹³ / ₁₆ "x11 ¹³ / ₁₆ "x1 ¹ / ₄ "x1 ¹ / ₄ " Pcs. Box 2 - LM x Box 0,60	E8LX	E8LZ	E8M1	● A66			
	Outdoor Nat. Rett. 30x30x3,2x3,2 11 ¹³ / ₁₆ "x11 ¹³ / ₁₆ "x1 ¹ / ₄ "x1 ¹ / ₄ " Pcs. Box 2 - LM x Box 0,60	E8LY	E8M0	E8M2	● A66			
 Battiscopa Scala Dx Sx Tread Skirting Dx Sx	Indoor Nat. Rett. 7x60x60 - 2 ³ / ₄ "x23 ⁵ / ₈ "x23 ⁵ / ₈ " Pcs. Box 2 - LM x Box 1,20	DX E73J	SX E1V5	DX E73K	SX E73L	DX E841	SX E842	● A33

IMBALLI E PESI

Packing and Weight | Emballages et Poids | Verpackung und Gewicht | Embalajes y Pesos | Упаковка и Вес

Formato Size Format Format Tamaño Формат cm	Spessore Thickness Epaisseur Stärke Espesor Толщина mm	Pz. x Mq. Pieces x Sqm Pcs / M ² Stk. x Qm Pzs x Mc. Шт x Кв.М.	Pz. x Scat. Pieces x Box Pcs / Bte Stk. x Krt. Pzs x Caja Шт x Кор.	Mq. x Scat. Sqm x Box M ² / Bte Qm x Krt. Mc. x Caja Кв.М. x Кор.	Peso x Scat. Weight x Box Poids / Bte Gewicht x Krt. Peso x Caja Вес x Кор. Kg	Scat. x Pal. Boxes x Pal. Bte / Pal. Krt. x Pal. Cajas x Pal. Кор. x Подд.	Mq. x Pal. Sqm x Pal. M ² / Pal. Qm x Pal. Mc. x Pal. Кв.М x Подд.	Peso x Pal. Weight x Pal. Poids / Pal. Gewicht x Pal. Peso x Pal. Вес x Подд. Kg
30x60 Naturale	9,5	5,56	6	1,08	23,76	48	51,84	1140
30x60 Listelli Sfalsati Naturale	9,5	5,56	4	0,72	15,80	30	21,60	474
30x30 Mosaico Naturale	9,5	11,11	5	0,45	8,73	60	27,00	524

* Su rete in fibra - On fibre mesh backing - Sur filet en fibre de verre - Auf Glasfasernetz - Sobre malla de fibra - На волоконной сетке

BE-SQUARE



PRODUCT CERTIFIED FOR LOW CHEMICAL EMISSIONS:
ULCDM/CG
UL 2818

FORMATI

Sizes | Formats | Formate | Tamaños | Форматы

6,5 mm. 120x278 - 47^{1/4}"x109^{7/16}" Nat.
120x240 - 47^{1/4}"x94^{1/2}" Nat.
120x120 - 47^{1/4}"x47^{1/4}" Nat.
60x120 - 23^{5/8}"x47^{1/4}" Nat.

9,5 mm. 60x120 - 23^{5/8}"x47^{1/4}" Nat.
60x60 - 23^{5/8}"x23^{5/8}" Nat. - Lapp.
30x60 - 11^{13/16}"x23^{5/8}" Nat.
80x80 - 31^{1/2}"x31^{1/2}" Nat. - Lapp.
40x80 - 15^{3/4}"x31^{1/2}" Nat.
20x20 - 7^{7/8}"x7^{7/8}" Nat.

20MM 80x80 - 31^{1/2}"x31^{1/2}" Nat.
60x60 - 23^{5/8}"x23^{5/8}" Nat.

SUPERFICI

Finishes | Finitions | Oberflächen
Superficies | Отделка поверхности

NATURALE

R10 DIN 51130
B (A+B) DIN 51097
Wet \geq 0,50 DCOF
 \geq 0,40 B.C.R.A.
P2 Pendolo AS 4586
< 36 Moderate Slip potential Pendolo BS 7976
- Pendolo UNE 41901

LAPPATO

- DIN 51130
- DIN 51097
Wet \geq 0,42 DCOF
 \geq 0,40 B.C.R.A.
- Pendolo AS 4586
- Pendolo BS 7976
- Pendolo UNE 41901

20MM

R11 DIN 51130
C (A+B+C) DIN 51097
Wet \geq 0,65 DCOF
 \geq 0,40 B.C.R.A.
P3 Pendolo AS 4586
> 36 Low Slip potential Pendolo BS 7976
3 Pendolo UNE 41901

SHADE VARIATIONS



DESTINAZIONI D'USO

Intended uses | Domaines d'application
Zweckbestimmung | Usos previstos | Назначение

NATURALE - 20MM



LAPPATO



IVORY

SAND

CONCRETE

BLACK

BE-SQUARE

COLORI E FORMATI

Colours and Sizes | Couleurs et Formats | Farben und Formate | Colores y Tamaños | Цвета и Форматы

Ivory



Sand



Concrete



Black



Si consiglia la posa con fuga 2 mm. - Laying with a 2 mm-joint is recommended. - Pose recommandée avec joints de 2 mm.
Es wird eine Fugenbreite von 2 mm empfohlen. - Se recomienda la colocación con juntas de 2 mm. - Рекомендуется укладка с швом 2 мм.

BE-SQUARE SLIM

COLORI E FORMATI

Colours and Sizes | Couleurs et Formats | Farben und Formate | Colores y Tamaños | Цвета и Форматы

6,5 mm.



Slim Naturale Rett.

120x278 - 47^{1/4}"x109^{7/16}"

- EKDM Ivory ● T99
- EKDN Sand ● T99
- EKDP Concrete ● T99
- EKDQ Black ● T99



Slim Naturale Rett.

120x240 - 47^{1/4}"x94^{1/2}"

- EDPK Ivory ● T92
- EDPL Sand ● T92
- EDPM Concrete ● T92
- EDPN Black ● T92

Fino ad esaurimento scorte. - While stock last. - Jusqu'à épuisement des stocks.
Solange der Vorrat reicht. - Hasta agotar existencias. - Пока на складе есть в наличии.

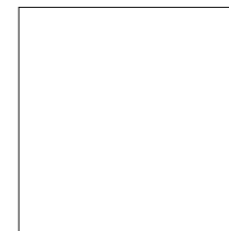

Slim Naturale Rett.

120x120 - 47^{1/4}"x47^{1/4}"

- EDPF Ivory ● T74
- EDPG Sand ● T74
- EDPH Concrete ● T74
- EDPJ Black ● T74

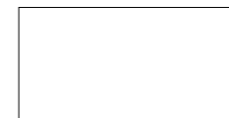

Slim Naturale Rett.

60x120 - 23^{5/8}"x47^{1/4}"

- EKDG Ivory ● T59
- EKDH Sand ● T59
- EKDJ Concrete ● T59
- EKDK Black ● T59

Verificare l'abbinamento dei toni tra i formati differenti. - Check the colour matching between different sizes.
Vérifier l'assortiment des tonalités entre les différents formats. - Die Kombination der Farbtöne unter den verschiedenen Formaten prüfen.
Comprobar la combinación de los tonos entre los distintos formatos. - Проверьте сочетание тонов у разных форматов.

COLORI E FORMATI

Colours and Sizes | Couleurs et Formats | Farben und Formate | Colores y Tamaños | Цвета и Форматы

9,5 mm.



Naturale Rett.

60x120 - 23^{5/8}"x47^{1/4}"

- ECXU Ivory U₄P₃E₃C₂ ● T31
- ECXV Sand U₄P₃E₃C₂ ● T31
- ECXW Concrete U₄P₃E₃C₂ ● T31
- ECXX Black U₄P₃E₃C₂ ● T31

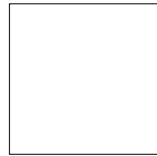

Naturale Rett.

80x80 - 31^{1/2}"x31^{1/2}"

- ECXG Ivory U₄P₃E₃C₂ ● T25
- ECXH Sand U₄P₃E₃C₂ ● T25
- ECXJ Concrete U₄P₃E₃C₂ ● T25
- ECXK Black U₄P₃E₃C₂ ● T25



Naturale Rett.

40x80 - 15^{3/4}"x31^{1/2}"

- ECX3 Ivory U₄P₄E₃C₂ ● T23
- ECX4 Sand U₄P₄E₃C₂ ● T23
- ECX5 Concrete U₄P₄E₃C₂ ● T23
- ECX6 Black U₄P₄E₃C₂ ● T23



Naturale Rett.

60x60 - 23^{5/8}"x23^{5/8}"

- ECX7 Ivory U₄P₄E₃C₂ ● T17
- ECX8 Sand U₄P₄E₃C₂ ● T17
- ECX9 Concrete U₄P₄E₃C₂ ● T17
- ECXA Black U₄P₄E₃C₂ ● T17



Naturale Rett.

30x60 - 11^{13/16}"x23^{5/8}"

- ECXC Ivory U₄P₄E₃C₂ ● T14
- ECXD Sand U₄P₄E₃C₂ ● T14
- ECXE Concrete U₄P₄E₃C₂ ● T14
- ECXF Black U₄P₄E₃C₂ ● T14



Naturale

20x20 - 7^{7/8}"x7^{7/8}"

- ED0A Ivory ● T12
- ED0C Sand ● T12
- ED0D Concrete ● T12
- ED0E Black ● T12

Lappato Rett.

80x80 - 31^{1/2}"x31^{1/2}"

- EDCM Ivory ● T39
- EDCN Sand ● T39
- EDCP Concrete ● T39
- EDCQ Black ● T39

Lappato Rett.

60x60 - 23^{5/8}"x23^{5/8}"

- EEN7 Ivory ● T26
- EEN8 Sand ● T26
- EEM3 Concrete ● T26
- EEN9 Black ● T26

20MM

Naturale Rett.

80x80 - 31^{1/2}"x31^{1/2}"

- ECR7 Concrete U₃₈P₃E₃C₂F₊ ● T67

Naturale Rett.

60x60 - 23^{5/8}"x23^{5/8}"

- ECYS Ivory ● T34
- ECYT Sand ● T34
- ECYU Concrete ● T34
- ECYV Black ● T34

DECORI

Decors | Decors | Dekore | Decorados | Декоры

OPTICAL



30x30 - 11^{13/16}"x11^{13/16}"

EDRP Ivory/Sand Nat. Rett.

Pcs. Box 4

● A34

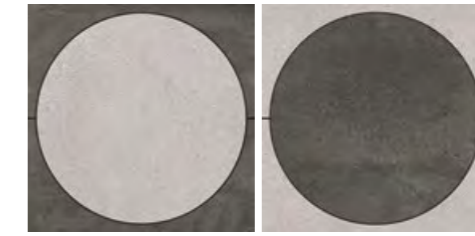

30x30 - 11^{13/16}"x11^{13/16}"

EDRQ Concrete/Black Nat. Rett.

Pcs. Box 4

● A34

MOSAICO 3X3*

Tessera - Chip 2,8x2,8 - 1^{1/8}"x1^{1/8}"



30x30 - 11^{13/16}"x11^{13/16}"

EDPT Ivory Nat. ● A96



30x30 - 11^{13/16}"x11^{13/16}"

EDPU Sand Nat. ● A96

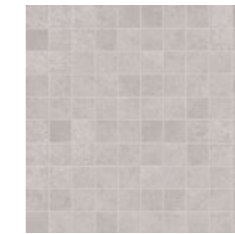

30x30 - 11^{13/16}"x11^{13/16}"

EDPV Concrete Nat. ● A96

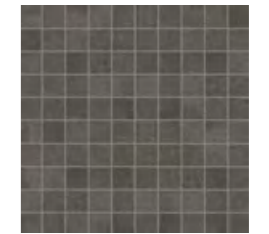

30x30 - 11^{13/16}"x11^{13/16}"

EDPW Black Nat. ● A96

LISTELLI SFALSATI*

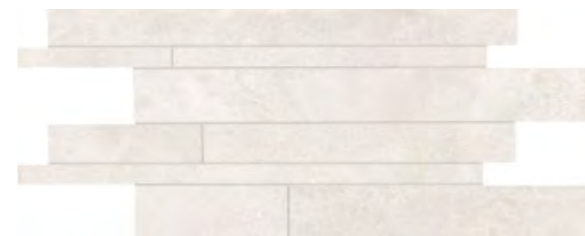

30x60 - 11^{13/16}"x23^{5/8}"

ED8K Ivory Nat.

● A80

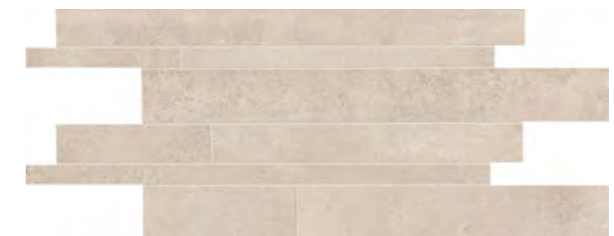

30x60 - 11^{13/16}"x23^{5/8}"

ED8L Sand Nat.

● A80

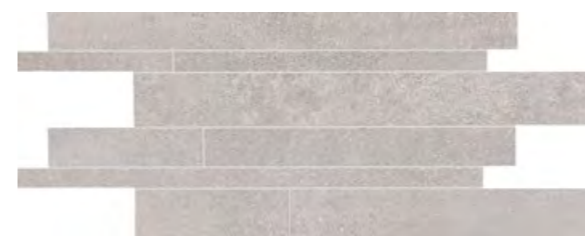

30x60 - 11^{13/16}"x23^{5/8}"

ED8M Concrete Nat.

● A80

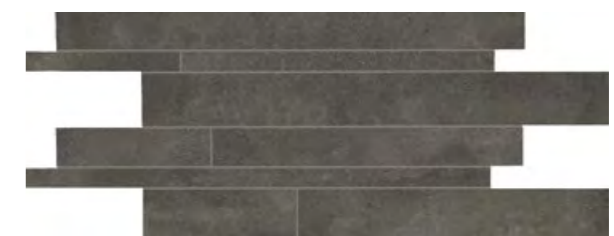

30x60 - 11^{13/16}"x23^{5/8}"

ED8N Black Nat.

● A80

Si consiglia la posa con fuga 2 mm. - Laying with a 2 mm-joint is recommended. - Pose recommandée avec joints de 2 mm.
Es wird eine Fugenbreite von 2 mm empfohlen. - Se recomienda la colocación con juntas de 2 mm. - Рекомендуется укладка с швом 2 мм.

Verificare l'abbinamento dei toni tra i formati differenti. - Check the colour matching between different sizes.
Vérifier l'assortiment des tonalités entre les différents formats. - Die Kombination der Farbtöne unter den verschiedenen Formaten prüfen.
Comprobar la combinación de los tonos entre los distintos formatos. - Проверьте сочетание тонов у разных форматов.

* Su rete in fibra - On fibre mesh backing - Sur filet en fibre de verre - Auf Glasfasernetz - Sobre malla de fibra - На волоконной сетке

BE-SQUARE

DECORI

Decors | Decors | Dekore | Decorados | Декоры

BEDECOR MAJOLICA MIX



20x20 - 7⁷/₈" x 7⁷/₈"

ED07 Rett.

● T94

BEDECOR MAJOLICA SINGLE



20x20 - 7⁷/₈" x 7⁷/₈"

ED09 Rett.

● T94

20DECOR



20x20 - 7⁷/₈" x 7⁷/₈"

ED62 Nat.

● T12

BEDECOR CONCRETE MIX



20x20 - 7⁷/₈" x 7⁷/₈"

ED06 Nat. Rett.

● T94

BEDECOR CONCRETE SINGLE



20x20 - 7⁷/₈" x 7⁷/₈"



ED08 Nat. Rett.

● T94

BE-SQUARE



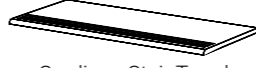





PEZZI SPECIALI

Trims | Pieces Speciales | Formteile | Piezas Especiales | Специальные Изделия

	Dimensione Size	Ivory	Sand	Concrete	Black	Fascia di prezzo Price band				
 Battiscopa - Skirting	Nat. Rett. 7x60 - 2 ³ / ₄ " x 23 ⁵ / ₈ " Pcs. Box 15 - LM x Box 9,00	ECZV	ECZW	ECZX	ECZY	● A11				
	Nat. Rett. 4,6x80 - 1 ¹³ / ₁₆ " x 31 ¹ / ₂ " Pcs. Box 12 - LM x Box 9,60	ECYJ	ECYK	ECYL	ECYM	● A16				
 Gradino - Stair Tread	Nat. Rett. 33x120 - 12 ¹⁵ / ₁₆ " x 47 ¹ / ₄ " Pcs. Box 2 - LM x Box 2,40	ED8Q	ED8R	ED8S	ED8T	● A82				
 Gradone - Step	Nat. Rett. 33x120x3,2x3,2 12 ¹⁵ / ₁₆ " x 47 ¹ / ₄ " x 1 ¹ / ₄ " x 1 ¹ / ₄ " Pcs. Box 2 - LM x Box 2,40	ECYN	ECYP	ECYQ	ECYR	● A98				
 Angolare Dx Sx Corner Tile Dx Sx	Nat. Rett. 33x120x3,2x3,2 12 ¹⁵ / ₁₆ " x 47 ¹ / ₄ " x 1 ¹ / ₄ " x 1 ¹ / ₄ " Pcs. Box 1 - LM x Box 1,20	DX ECY9	SX ECYA	DX ECYC	SX ECYD	DX ECYE	SX ECYF	DX ECYG	SX ECYH	● A104

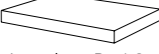
20MM PEZZI SPECIALI

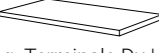
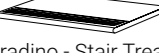
Trims | Pieces Speciales | Formteile | Piezas Especiales | Специальные Изделия





	Dimensione Size	 Ivory	 Sand	 Concrete	 Black	Fascia di prezzo Price band				
	Nat. Rett. 33x60x5 12 ^{15/16} "x23 ^{5/8} "x1 ^{15/16} " Pcs. Box 2 - LM x Box 1,20	ECZ0	ECZ3	ECZ6	ECZ9	● A68				
	Nat. Rett. 33x80x5 12 ^{15/16} "x31 ^{1/2} "x1 ^{15/16} " Pcs. Box 2 - LM x Box 1,60	-	-	EENA	-	● A80				
	Nat. Rett. 33x60x5 12 ^{15/16} "x23 ^{5/8} "x1 ^{15/16} " Pcs. Box 2 - LM x Box 1,20	DX ECZ1	SX ECZ2	DX ECZ4	SX ECZ5	DX ECZ7	SX ECZ8	DX ECZA	SX ECZC	● A90
	Nat. Rett. 33x80x5 12 ^{15/16} "x31 ^{1/2} "x1 ^{15/16} " Pcs. Box 2 - LM x Box 1,60	-	-	-	-	DX EENC	SX EEND	-	-	● A96
	Nat. Rett. 33x60x2,5 12 ^{15/16} "x23 ^{5/8} "x1 ^{15/16} " Pcs. Box 2 - LM x Box 1,20	ECZD	ECZG	ECZK	ECZN					● A72
	Nat. Rett. 33x80x2,5 12 ^{15/16} "x31 ^{1/2} "x1 ^{15/16} " Pcs. Box 2 - LM x Box 1,60	-	-	-	-	EENG				
	Nat. Rett. 33x60x2,5 12 ^{15/16} "x23 ^{5/8} "x1 ^{15/16} " Pcs. Box 2 - LM x Box 1,20	DX ECZE	SX ECZF	DX ECZH	SX ECZJ	DX ECZL	SX ECZM	DX ECZP	SX ECZQ	● A90
	Nat. Rett. 33x80x2,5 12 ^{15/16} "x31 ^{1/2} "x1 ^{15/16} " Pcs. Box 2 - LM x Box 1,60	-	-	-	-	DX EENH	SX EENJ	-	-	● A96
	Nat. Rett. 33x60 - 12 ^{15/16} "x23 ^{5/8} " Pcs. Box 2 - LM x Box 1,20	ECZR	ECZS	ECZT	ECZU					● A66
	Nat. Rett. 33x80 - 12 ^{15/16} "x31 ^{1/2} " Pcs. Box 2 - LM x Box 1,60	-	-	EENE	-					● A80
	Nat. Rett. 16,5x60 - 6 ^{1/2} "x23 ^{5/8} " Pcs. Box 2 - LM x Box 1,20	ECYW	ECYX	ECYY	ECYZ					● A29
	Nat. Rett. 16,5x80 - 6 ^{1/2} "x31 ^{1/2} " Pcs. Box 4 - LM x Box 3,20	-	-	EENF	-					● A44

IMBALLI E PESI

Packing and Weight | Emballages et Poids | Verpackung und Gewicht | Embalajes y Pesos | Упаковка и Вес

Formato Size Format Format Tamaño Формат cm	Spessore Thickness Epaisseur Stärke Espesor Толщина mm	Pz. x Mq. Pieces x Sqm Pcs / M ² Stk. x Qm Pzs x Mc. Шт x Кв.М.	Pz. x Scat. Pieces x Box Pcs / Bte Stk. x Krt. Pzs x Caja Шт x Кор.	Mq. x Scat. Sqm x Box M ² / Bte Qm x Krt. Mc. x Caja Кв.М. x Кор.	Peso x Scat. Weight x Box Poids / Bte Gewicht x Krt. Peso x Caja Вес x Кор. Kg	Scat. x Pal. Boxes x Pal. Bte / Pal. Krt. x Pal. Cajas x Pal. Кор. x Подд.	Mq. x Pal. Sqm x Pal. M ² / Pal. Qm x Pal. Mc. x Pal. Кв.М x Подд.	Peso x Pal. Weight x Pal. Poids / Pal. Gewicht x Pal. Peso x Pal. Вес x Подд. Kg
120x278 Naturale	6,5	0,30	1	3,34	50,04	vedi sotto - see below		
120x240 Naturale	6,5	0,35	1	2,88	43,20			
120x120 Naturale	6,5	0,69	2	2,88	43,20	20	57,60	984
60x120 Naturale	6,5	1,39	3	2,16	32,40	15	32,40	486
60x120 Naturale	9,5	1,39	2	1,44	31,68	36	51,84	1140
80x80 Naturale - Lappato	9,5	1,56	2	1,28	28,16	42	53,76	1183
40x80 Naturale	9,5	3,13	3	0,96	21,12	28	26,88	591
60x60 Naturale - Lappato	9,5	2,78	3	1,08	23,76	40	43,20	950
30x60 Naturale	9,5	5,56	6	1,08	23,76	48	51,84	1140
20x20 Naturale - 20Decor	9,5	25,00	24	0,96	21,12	54	51,84	1140
30x60 Listelli sfalsati	9,5	5,56	4	0,72	15,80	30	21,60	474
30x30 Mosaico 3X3	9,5	11,11	5	0,45	8,73	60	27,00	524
20x20 BeDecor	9,5	25,00	18	0,68	15,84	72	48,96	1140
80x80 Naturale 20MM	20	1,56	1	0,64	29,44	45	28,80	1325
60x60 Naturale 20MM	20	2,78	2	0,72	33,12	32	23,04	1060

Slabs 120x240 - 120x278

Articolo Item Reference Artikel Articulo Артикула	Dimensione (cm) Size (cm) Format (cm) Format (cm) Tamaño (cm) Формат (cm)	Nr. Lastre No. of Slabs Nbre Dalles Anz. Platten Nº de Placas Кол. Плит	Mq. x Imballo sqm per Pack m ² / Emballage qm pro Verpackung m ² por embalaje Кв.м. x упаковку	Peso Imballo (Kg) Weight of Packaging (kg) Poids Emballage (kg) Gewicht Verpackung (kg) Peso embalaje (kg) Вес упаковки (кг)	Peso Imballo+Lastre (Kg) Weight of Packaging + Slabs (kg) Poids Emballage+Dalles (kg) Gewicht Verpackung+Platten (kg) Peso embalaje + placas (kg) Вес упаковки + плит (кг)
 120x278	136,5x291,5x41,5h	18	60,05	120	1081
 120x240	136x266x18h	20	57,60	99	1020,6
 120x278	75x290x160h	40	133,44	180	2315
 120x240	75x250x159,6h	48	138,24	163	2375

CHATEAU



PRODUCT CERTIFIED FOR LOW CHEMICAL EMISSIONS:
UL/CDM/CG
UL 2818

FORMATI

Sizes | Formats | Formate | Tamaños | Форматы

- 9,5 mm. 120x120 - 47^{1/4}"x47^{1/4}" Nat. - Lapp.
- 60x120 - 23^{5/8}"x47^{1/4}" Nat. - Lapp.
- 80x80 - 31^{1/2}"x31^{1/2}" Nat. - Lapp.
- 40x80 - 15^{3/4}"x31^{1/2}" Nat. - Lapp.
- 60x60 - 23^{5/8}"x23^{5/8}" Nat. - Lapp. - Antislip
- 30x60 - 11^{13/16}"x23^{5/8}" Nat. - Lapp.

20MM

80x80 - 31^{1/2}"x31^{1/2}" Naturale

SUPERFICI

Finishes | Finitions | Oberflächen
Superficies | Отделка поверхности

NATURALE

R10 DIN 51130

B (A+B) DIN 51097

Wet $\geq 0,50$ DCOF

$\geq 0,40$ B.C.R.A.

P3 Pendolo AS 4586

> 36 Low Slip potential Pendolo BS 7976

2 Pendolo UNE 41901

LAPPATO

R9 DIN 51130

- DIN 51097

Wet $\geq 0,42$ DCOF

$\geq 0,40$ B.C.R.A.

- Pendolo AS 4586

- Pendolo BS 7976

- Pendolo UNE 41901

ANTISLIP | 20MM

R11 DIN 51130

C (A+B+C) DIN 51097

Wet $\geq 0,65$ DCOF

$\geq 0,40$ B.C.R.A.

P4 Pendolo AS 4586

> 36 Low Slip potential Pendolo BS 7976

3 Pendolo UNE 41901

SHADE VARIATIONS



V3 HIGH

DESTINAZIONI D'USO

Intended uses | Domaines d'application
Zweckbestimmung | Usos previstos | Назначение

NATURALE - 20MM



LAPPATO



BLANC



BEIGE



GRIS



NOIR

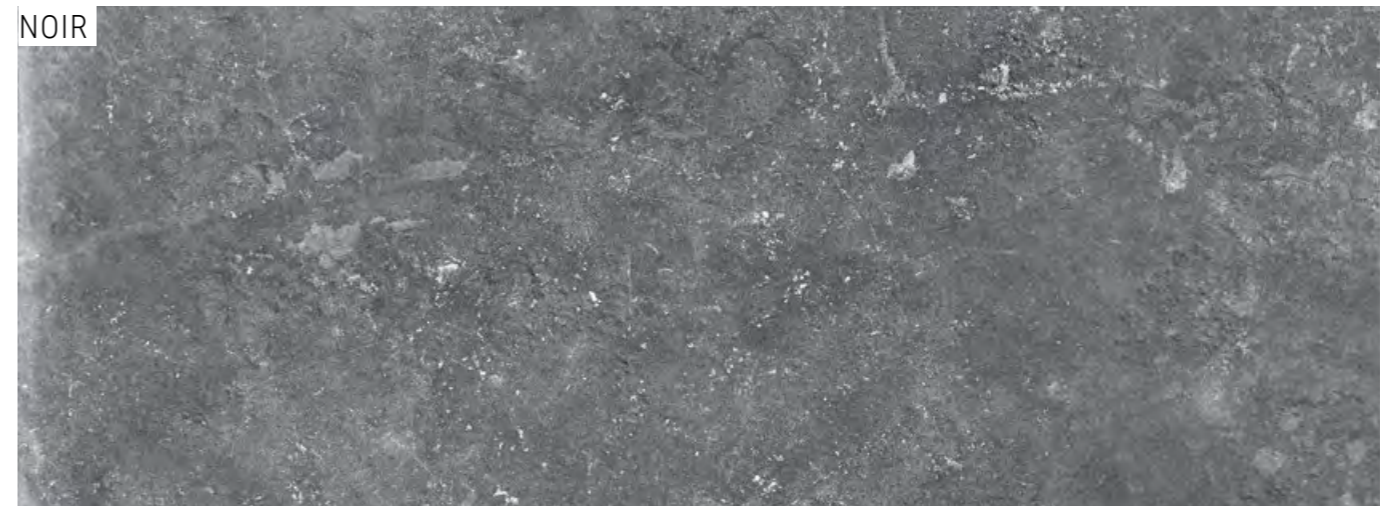

CHATEAU

COLORI E FORMATI

Colours and Sizes | Couleurs et Formats | Farben und Formate | Colores y Tamaños | Цвета и Форматы

Blanc

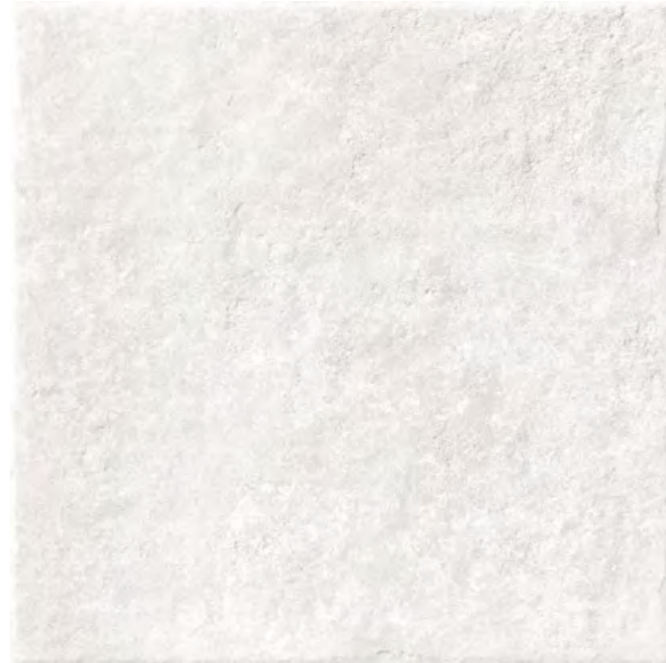

Beige



Gris



Noir

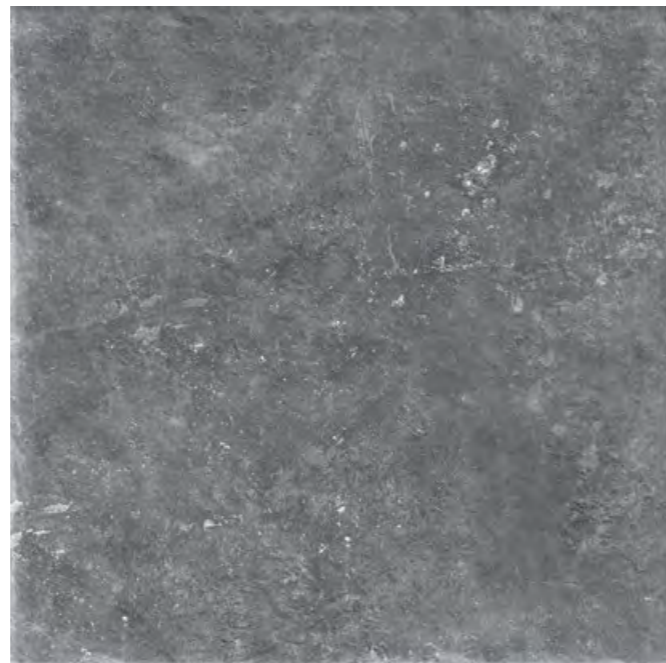

Si consiglia la posa con fuga 2 mm. - Laying with a 2 mm-joint is recommended. - Pose recommandée avec joints de 2 mm.
Es wird eine Fugenbreite von 2 mm empfohlen. - Se recomienda la colocación con juntas de 2 mm. - Рекомендуется укладка с швом 2 мм.

CHATEAU

COLORI E FORMATI

Colours and Sizes | Couleurs et Formats | Farben und Formate | Colores y Tamaños | Цвета и Форматы

9,5 mm.

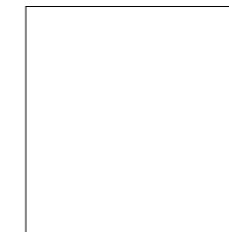

Naturale Rett.
° 120x120 - 47^{1/4}"x47^{1/4}"
EFLA Blanc ● T59
EFLC Beige ● T59
EFLD Gris ● T59
EFLF Noir ● T59



Naturale Rett.
60x120 - 23^{5/8}"x47^{1/4}"
EFLP Blanc U₄P₃E₃C₂ ● T31
EFLQ Beige U₄P₃E₃C₂ ● T31
EFLR Gris U₄P₃E₃C₂ ● T31
EFLS Noir U₄P₃E₃C₂ ● T31

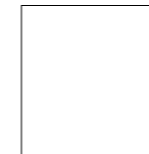

Naturale Rett.
80x80 - 31^{1/2}"x31^{1/2}"
EFL1 Blanc U₄P₃E₃C₂ ● T25
EFL2 Beige U₄P₃E₃C₂ ● T25
EFL3 Gris U₄P₃E₃C₂ ● T25
EFL4 Noir U₄P₃E₃C₂ ● T25



Naturale Rett.
40x80 - 15^{3/4}"x31^{1/2}"
EFL5 Blanc U₄P₄E₃C₂ ● T23
EFL6 Beige U₄P₄E₃C₂ ● T23
EFL7 Gris U₄P₄E₃C₂ ● T23
EFL8 Noir U₄P₄E₃C₂ ● T23



Naturale Rett.
60x60 - 23^{5/8}"x23^{5/8}"
EFLT Blanc U₄P₄₊E₃C₂ ● T17
EFLU Beige U₄P₄₊E₃C₂ ● T17
EFLV Gris U₄P₄₊E₃C₂ ● T17
EFLW Noir U₄P₄₊E₃C₂ ● T17



Naturale Rett.
30x60 - 11^{13/16}"x23^{5/8}"
EFLX Blanc U₄P₄E₃C₂ ● T14
EFLY Beige U₄P₄E₃C₂ ● T14
EFLZ Gris U₄P₄E₃C₂ ● T14
EFL0 Noir U₄P₄E₃C₂ ● T14

20MM



Naturale Rett.
80x80 - 31^{1/2}"x31^{1/2}"
EFM0 Blanc U₄P₃E₃C₂F₊ ● T67
EFM1 Beige U₄P₃E₃C₂F₊ ● T67
EFM2 Gris U₄P₃E₃C₂F₊ ● T67
EFM3 Noir U₄P₃E₃C₂F₊ ● T67

Lappato Rett.
° 120x120 - 47^{1/4}"x47^{1/4}"
EFLF Blanc ● T88
EFLG Beige ● T88
EFLH Gris ● T88
EFLJ Noir ● T88

Lappato Rett.
60x120 - 23^{5/8}"x47^{1/4}"
EFL9 Blanc ● T49
EFMA Beige ● T49
EFMC Gris ● T49
EFMD Noir ● T49

Lappato Rett.
80x80 - 31^{1/2}"x31^{1/2}"
EFMN Blanc ● T39
EFMP Beige ● T39
EFMQ Gris ● T39
EFMR Noir ● T39

Lappato Rett.
40x80 - 15^{3/4}"x31^{1/2}"
EFMS Blanc ● T35
EFMT Beige ● T35
EFMU Gris ● T35
EFMV Noir ● T35

Lappato Rett.
60x60 - 23^{5/8}"x23^{5/8}"
EFME Blanc ● T26
EFMF Beige ● T26
EFMG Gris ● T26
EFMH Noir ● T26

Lappato Rett.
30x60 - 11^{13/16}"x23^{5/8}"
EFMJ Blanc ● T23
EFMK Beige ● T23
EFML Gris ● T23
EFMM Noir ● T23

La smussatura dei bordi che caratterizza i formati più piccoli, viene eliminata nel 120x120 - 47^{1/4}"x47^{1/4}" per esaltare ulteriormente la modernità e sobrietà del formato maxi. Si consiglia pertanto una posa esclusiva del 120x120 - 47^{1/4}"x47^{1/4}" e non a modulo con gli altri formati.

The bevelling of the edges that characterizes the smaller sizes, is eliminated in 120x120 - 47^{1/4}"x47^{1/4}" to further enhance the modernity and sobriety of the maxi format. We therefore recommend an exclusive laying of 120x120 - 47^{1/4}"x47^{1/4}" and not to mix it with other formats.

Antislip Rett.
60x60 - 23^{5/8}"x23^{5/8}"
EFMW Blanc ● T17
EFMX Beige ● T17
EFMY Gris ● T17
EFMZ Noir ● T17

Verificare l'abbinamento dei toni tra i formati differenti. - Check the colour matching between different sizes.
Vérifier l'assortiment des tonalités entre les différents formats. - Die Kombination der Farbtöne unter den verschiedenen Formaten prüfen.
Comprobar la combinación de los tonos entre los distintos formatos. - Проверьте сочетание тонов у разных форматов.

DECORI

Decors | Decors | Dekore | Decorados | Декоры

MOSAICO 5X5*

Tessera - Chip 4,8x4,8 - 1^{7/8}"x1^{7/8}"



30x30 - 11^{13/16}"x11^{13/16}"
EFSY Blanc Nat. ● A86



30x30 - 11^{13/16}"x11^{13/16}"
EFSZ Beige Nat. ● A86



30x30 - 11^{13/16}"x11^{13/16}"
EFT0 Gris Nat. ● A86

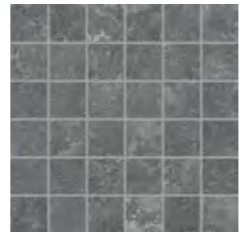

30x30 - 11^{13/16}"x11^{13/16}"
EFT1 Noir Nat. ● A86

MOSAICO MUR*



30x30 - 11^{13/16}"x11^{13/16}"
EFT2 Blanc Nat. ● A100



30x30 - 11^{13/16}"x11^{13/16}"
EFT3 Beige Nat. ● A100



30x30 - 11^{13/16}"x11^{13/16}"
EFT4 Gris Nat. ● A100



30x30 - 11^{13/16}"x11^{13/16}"
EFT5 Noir Nat. ● A100

MOSAICO PETITE MUR*



30x30 - 11^{13/16}"x11^{13/16}"
EFTU Blanc Nat. ● A105



30x30 - 11^{13/16}"x11^{13/16}"
EFTV Beige Nat. ● A105



30x30 - 11^{13/16}"x11^{13/16}"
EFTW Gris Nat. ● A105



30x30 - 11^{13/16}"x11^{13/16}"
EFTX Noir Nat. ● A105

* Su rete in fibra - On fibre mesh backing - Sur filet en fibre de verre - Auf Glasfasernetz - Sobre malla de fibra - На волоконной сетке

IMBALLI E PESI

Packing and Weight | Emballages et Poids | Verpackung und Gewicht | Embalajes y Pesos | Упаковка и Вес

Formato Size Format Format Тamaño Формат cm	Spessore Thickness Epaisseur Stärke Espesor Толщина mm	Pz. x Mq. Pieces x Sqm Pcs / M ² Stk. x Qm Pzs x Mc. Шт x Кв.М.	Pz. x Scat. Pieces x Box Pcs / Bte Stk. x Krt. Pzs x Caja Шт x Кор.	Mq. x Scat. Sqm x Box M ² / Bte Qm x Krt. Mc. x Caja Кв.М. x Кор.	Peso x Scat. Weight x Box Poids / Bte Gewicht x Krt. Peso x Caja Вес x Кор. Kg	Scat. x Pal. Boxes x Pal. Bte / Pal. Krt. x Pal. Cajas x Pal. Кор. x Подд.	Mq. x Pal. Sqm x Pal. M ² / Pal. Qm x Pal. Mc. x Pal. Кв.М x Подд.	Peso x Pal. Weight x Pal. Poids / Pal. Gewicht x Pal. Peso x Pal. Вес x Подд. Kg
120x120 Naturale - Lappato	9,5	0,69	1	1,44	31,68	36	51,84	1140
60x120 Naturale - Lappato	9,5	1,39	2	1,44	31,68	36	51,84	1140
80x80 Naturale - Lappato	9,5	1,56	2	1,28	28,16	42	53,76	1183
40x80 Naturale - Lappato	9,5	3,13	3	0,96	21,12	28	26,88	591
60x60 Nat. - Lappato - Antislip	9,5	2,78	3	1,08	23,76	40	43,20	950
30x60 Naturale - Lappato	9,5	5,56	6	1,08	23,76	48	51,84	1140
30x30 Mosaico 5X5 Naturale	9,5	11,11	5	0,45	8,73	60	27,00	524
30x30 Mosaico Mur - Petit Mur Naturale	9,5	11,11	5	0,45	8,73	60	27,00	524
80x80 Naturale 20MM	20	1,56	1	0,64	29,44	45	28,80	1325

PEZZI SPECIALI

Trims | Pieces Speciales | Formteile | Piezas Especiales | Специальные Изделия

	Dimensione Size	Blanc	Beige	Gris	Noir	Fascia di prezzo Price band				
 Battiscopa - Skirting	Nat. Rett. 7x60 - 2 ^{3/4} "x23 ^{5/8} " Pcs. Box 15 - LM x Box 9,00	EFTY	EFTZ	EFU0	EFU1	● A11				
	Nat. Rett. 4,6x80 - 1 ^{13/16} "x31 ^{1/2} " Pcs. Box 12 - LM x Box 9,60	EFU2	EFU3	EFU4	EFU5	● A16				
 Gradino - Stair Tread	Nat. Rett. 33x120 - 12 ^{15/16} "x47 ^{1/4} " Pcs. Box 2 - LM x Box 2,40	EFU6	EFU7	EFU8	EFU9	● A82				
	Nat. Rett. 33x120x3,2x3,2 12 ^{15/16} "x47 ^{1/4} "x1 ^{1/4} "x1 ^{1/4} " Pcs. Box 2 - LM x Box 2,40	EFUA	EFUC	EFUD	EFUE	● A98				
 Gradone - Step	Lapp. Rett. 33x120x3,2x3,2 12 ^{15/16} "x47 ^{1/4} "x1 ^{1/4} "x1 ^{1/4} " Pcs. Box 2 - LM x Box 2,40	EFUP	EFUQ	EFUR	EFUS	● A101				
	Nat. Rett. 33x120x3,2x3,2 12 ^{15/16} "x47 ^{1/4} "x1 ^{1/4} "x1 ^{1/4} " Pcs. Box 1 - LM x Box 1,20	DX EFUF	SX EFUK	DX EFUG	SX EFUL	DX EFUH	SX EFUM	DX EFUJ	SX EFUN	● A104
 Angolare Dx Sx Corner Tile Dx Sx	Lapp. Rett. 33x120x3,2x3,2 12 ^{15/16} "x47 ^{1/4} "x1 ^{1/4} "x1 ^{1/4} " Pcs. Box 1 - LM x Box 1,20	DX EFUT	SX EFUX	DX EFUU	SX EFUY	DX EFUV	SX EFUZ	DX EFUW	SX EFV0	● A106

20MM PEZZI SPECIALI

Trims | Pieces Speciales | Formteile | Piezas Especiales | Специальные Изделия

	Dimensione Size	Blanc	Beige	Gris	Noir	Fascia di prezzo Price band			
 Gradone - Step	Nat. Rett. 33x80x5 12 ^{15/16} "x31 ^{1/2} "x1 ^{15/16} " Pcs. Box 2 - LM x Box 1,60	EFV9	EFVA	EFVC	EFVD	● A80			
	Nat. Rett. 33x80x5 12 ^{15/16} "x31 ^{1/2} "x1 ^{15/16} " Pcs. Box 2 - LM x Box 1,60	DX EFVE	SX EFVJ	DX EFVF	SX EFVK	DX EFVG	SX EFVL	DX EFVH	SX EFVM
 Terminale - Endingpiece	Nat. Rett. 33x80x2,5 12 ^{15/16} "x31 ^{1/2} "x1 ^{15/16} " Pcs. Box 2 - LM x Box 1,60	EFVN	EFVP	EFVQ	EFVR	● A84			
	Nat. Rett. 33x80x2,5 12 ^{15/16} "x31 ^{1/2} "x1 ^{15/16} " Pcs. Box 2 - LM x Box 1,60	DX EFVS	SX EFVW	DX EFVT	SX EFVX	DX EFVU	SX EFVY	DX EFVV	SX EFVZ
 Gradino - Stair Tread	Nat. Rett. 33x80 - 12 ^{15/16} "x31 ^{1/2} " Pcs. Box 2 - LM x Box 1,60	EFV1	EFV2	EFV3	EFV4	● A80			
	Nat. Rett. 16,5x80 - 6 ^{1/2} "x31 ^{1/2} " Pcs. Box 4 - LM x Box 3,20	EFV5	EFV6	EFV7	EFV8	● A44			

DIMORE



PRODUCT CERTIFIED FOR LOW CHEMICAL EMISSIONS:
ULCDM/CG
UL 2818

FORMATI

Sizes | Formats | Formate | Tamaños | Форматы

9,5 mm.

20x120 - 77^{7/8} x 47^{1/4} Naturale

SUPERFICI

Finishes | Finitions | Oberflächen
Superficies | Отделка поверхности

NATURALE

R9 DIN 51130

A DIN 51097

Wet \geq 0,42 DCOF

\geq 0,40 B.C.R.A.

- Pendolo AS 4586

- Pendolo BS 7976

- Pendolo UNE 41901

SHADE VARIATIONS



V3 HIGH

DESTINAZIONI D'USO

Intended uses | Domaines d'application
Zweckbestimmung | Usos previstos | Назначение



15%



SBIANCATO

NATURALE

DORATO

TABACCO

COLORI E FORMATI

Colours and Sizes | Couleurs et Formats | Farben und Formate | Colores y Tamaños | Цвета и Форматы

Sbiancato



Naturale



Dorato



Tabacco



COLORI E FORMATI

Colours and Sizes | Couleurs et Formats | Farben und Formate | Colores y Tamaños | Цвета и Форматы

9,5 mm.

- Naturale** 20x120 - 7⁷/₈"x47¹/₄"
- EGN6** Sbiancato ● T11
- EGN7** Naturale ● T11
- EGN8** Dorato ● T11
- EGN9** Tabacco ● T11

Si consiglia la posa con fuga 2 mm.
Laying with a 2 mm-joint is recommended.
Pose recommandée avec joints de 2 mm.
Es wird eine Fugenbreite von 2 mm empfohlen.
Se recomienda la colocación con juntas de 2 mm.
Рекомендуется укладка с швом 2 мм.

DECORI

Decors | Decors | Dekore | Decorados | Декоры



20x20 - 7⁷/₈"x7⁷/₈"
EGNC Cubo ● T12



20x20 - 7⁷/₈"x7⁷/₈"
EGNF Diamante ● T12



20x20 - 7⁷/₈"x7⁷/₈"
EGNH Enigma ● T12



20x20 - 7⁷/₈"x7⁷/₈"
EGNJ Foglie ● T12



20x20 - 7⁷/₈"x7⁷/₈"
EGNL Petali ● T12



20x20 - 7⁷/₈"x7⁷/₈"
EGNM Riflesso ● T12



20x20 - 7⁷/₈"x7⁷/₈"
EGNQ Riquadro ● T12



20x20 - 7⁷/₈"x7⁷/₈"
EGNS Ventaglio ● T12

PEZZI SPECIALI

Trims | Peces Speciales | Formteile | Piezas Especiales | Специальные Изделия

	Dimensione Size	Sbiancato	Naturale	Dorato	Tabacco	Fascia di prezzo Price band
 Battiscopa - Skirting	Nat. 4,6x120 - 1 ¹³ / ₁₆ "x47 ¹ / ₄ " Pcs. Box. 6 - LM x Box 7,20	EGXJ	EGXK	EGXL	EGXM	● A22

IMBALLI E PESI

Packing and Weight | Emballages et Poids | Verpackung und Gewicht | Embalajes y Pesos | Упаковка и Вес

Formato Size Format Format Tamaño Формат cm	Spessore Thickness Épaisseur Stärke Espesor Толщина mm	Pz. x Mq. Pieces x Sqm Pcs / M ² Stk. x Qm Pzs x Mc. Шт x Кв.М.	Pz. x Scat. Pieces x Box Pcs / Bte Stk. x Krt. Pzs x Caja Шт x Кор.	Mq. x Scat. Sqm x Box M ² / Bte Qm x Krt. Mc. x Caja Кв.М. x Кор.	Peso x Scat. Weight x Box Poids / Bte Gewicht x Krt. Mc. x Caja Вес x Кор. Kg	Scat. x Pal. Boxes x Pal. Bte / Pal. Krt. x Pal. Cajas x Pal. Кор. x Подд.	Mq. x Pal. Sqm x Pal. M ² / Pal. Qm x Pal. Mc. x Pal. Кв.М x Подд.	Peso x Pal. Weight x Pal. Poids / Pal. Gewicht x Pal. Peso x Pal. Вес x Подд. Kg
20x120 Naturale	9,5	4,17	4	0,96	21,12	40	38,40	845
20x20 Decori	9,5	25,00	24	0,96	21,12	54	51,84	1140

ETERNA



PRODUCT CERTIFIED FOR LOW CHEMICAL EMISSIONS: ULCDM/CG UL 2818

FORMATI

Sizes | Formats | Formate | Tamaños | Форматы

9,5 mm.

60x120 - 23^{5/8}"x47^{1/4}" Naturale

60x60 - 23^{5/8}"x23^{5/8}" Naturale

30x60 - 11^{13/16}"x23^{5/8}" Naturale

7,5x30 - 2^{15/16}"x11^{13/16}" Naturale

SUPERFICI

Finishes | Finitions | Oberflächen
Superficies | Отделка поверхности

NATURALE

R9 DIN 51130

A DIN 51097

Wet \geq 0,42 DCOF

\geq 0,40 B.C.R.A.

- Pendolo AS 4586

- Pendolo BS 7976

- Pendolo UNE 41901

SHADE VARIATIONS



V3 HIGH

DESTINAZIONI D'USO

Intended uses | Domaines d'application
Zweckbestimmung | Usos previstos | Назначение



放射能水平低



12%



AVORIO



BEIGE



SILVER



TITANIO



ETERNA

COLORI E FORMATI

Colours and Sizes | Couleurs et Formats | Farben und Formate | Colores y Tamaños | Цвета и Форматы

Avorio



Beige



Silver



Titanio



Si consiglia la posa con fuga 2 mm. - Laying with a 2 mm-joint is recommended. - Pose recommandée avec joints de 2 mm.
Es wird eine Fugenbreite von 2 mm empfohlen. - Se recomienda la colocación con juntas de 2 mm. - Рекомендуется укладка с швом 2 мм.

ETERNA

COLORI E FORMATI

Colours and Sizes | Couleurs et Formats | Farben und Formate | Colores y Tamaños | Цвета и Форматы

 9,5 mm.



Naturale Rett.

60x120 - 23^{5/8}"x47^{1/4}"

ECJ9 Avorio ● T31

ECJA Beige ● T31



Naturale Rett.

60x60 - 23^{5/8}"x23^{5/8}"

ECHX Avorio ● T17

ECHY Beige ● T17



Naturale Rett.

30x60 - 11^{13/16}"x23^{5/8}"

ECJ1 Avorio ● T14

ECJ3 Beige ● T14

ECJ5 Silver ● T14

ECJ7 Titanio ● T14



Naturale Rett.

7,5x30 - 2^{15/16}"x11^{13/16}"

ECSA Avorio ● T61

ECSC Beige ● T61

ECSD Silver ● T61

ECSE Titanio ● T61

Verificare l'abbinamento dei toni tra i formati differenti. - Check the colour matching between different sizes.
Vérifier l'assortiment des tonalités entre les différents formats. - Die Kombination der Farbtöne unter den verschiedenen Formaten prüfen.
Comprobar la combinación de los tonos entre los distintos formatos. - Проверьте сочетание тонов у разных форматов.

DECORI

Decors | Decors | Dekore | Decorados | Декоры

DECORO ROME



30x60 - 11^{13/16}"x23^{5/8}"
ECJ2 Avorio Nat. Rett.

● T17



30x60 - 11^{13/16}"x23^{5/8}"
ECJ4 Beige Nat. Rett.

● T17



30x60 - 11^{13/16}"x23^{5/8}"
ECJ6 Silver Nat. Rett.

● T17

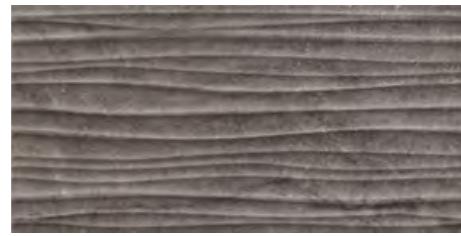

30x60 - 11^{13/16}"x23^{5/8}"
ECJ8 Titanio Nat. Rett.

● T17

MOSAICO 5X5*

Tessera - Chip 4,8x4,8 - 1^{7/8}"x1^{7/8}"

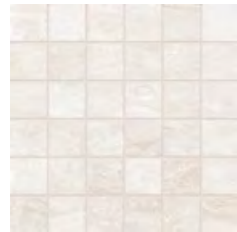

30x30 - 11^{13/16}"x11^{13/16}"
ECMA Avorio Nat. ● A86

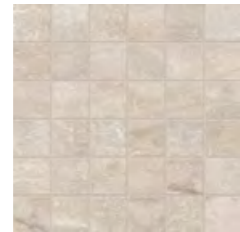

30x30 - 11^{13/16}"x11^{13/16}"
ECMA Beige Nat. ● A86

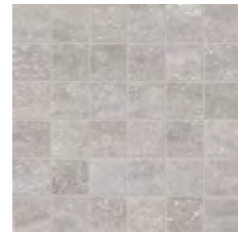

30x30 - 11^{13/16}"x11^{13/16}"
ECMA Silver Nat. ● A86



30x30 - 11^{13/16}"x11^{13/16}"
ECMA Titanio Nat. ● A86

MOSAICO APPIA*

Tessera - Chip 2,5x5 - 1^{5/16}"x1^{7/8}"



30x30 - 11^{13/16}"x11^{13/16}"
ECRR Avorio Nat. ● A102



30x30 - 11^{13/16}"x11^{13/16}"
ECRS Beige Nat. ● A102



30x30 - 11^{13/16}"x11^{13/16}"
ECRT Silver Nat. ● A102







30x30 - 11^{13/16}"x11^{13/16}"
ECRU Titanio Nat. ● A102

* Su rete in fibra - On fibre mesh backing - Sur filet en fibre de verre - Auf Glasfasernetz - Sobre malla de fibra - На волоконной сетке

PEZZI SPECIALI

Trims | Pieces Speciales | Formteile | Piezas Especiales | Специальные Изделия

	Dimensione Size	Avorio	Beige	Silver	Titanio	Fascia di prezzo Price band
 Battiscopa - Skirting	Nat. Rett. 7x60 - 2 ^{3/4} "x23 ^{5/8} " Pcs. Box 15 - LM x Box 9,00	ECMP	ECMR	ECMT	ECMV	● A11
 Gradino - Stair Tread	Nat. Rett. 33x120 - 12 ^{15/16} "x47 ^{1/4} " Pcs. Box 2 - LM x Box 2,40	ECMK	ECML	-	-	● A82
 Gradone - Step	Nat. Rett. 33x120x3,2x3,2 12 ^{15/16} "x47 ^{1/4} "x1 ^{1/4} "x1 ^{1/4} " Pcs. Box 2 - LM x Box 2,40	ECM1	ECM3	-	-	● A98
 Angolare Dx Sx Corner Tile Dx Sx	Nat. Rett. 33x120x3,2x3,2 12 ^{15/16} "x47 ^{1/4} "x1 ^{1/4} "x1 ^{1/4} " Pcs. Box 1 - LM x Box 1,20	DX ECLK	SX ECLL	DX ECLP	SX ECLQ	- - - - ● A104

IMBALLI E PESI

Packing and Weight | Emballages et Poids | Verpackung und Gewicht | Embalajes y Pesos | Упаковка и Вес

Formato Size Format Format Тamaño Формат cm	Spessore Thickness Epaisseur Stärke Espesor Толщина mm	Pz. x Mq. Pieces x Sqm Pcs / M ² Stk. x Qm Pzs x Mc. Шт x Кв.М.	Pz. x Scat. Pieces x Box Pcs / Bte Stk. x Krt. Pzs x Caja Шт x Кор.	Mq. x Scat. Sqm x Box M ² / Bte Qm x Krt. Mc. x Caja Кв.М. x Кор.	Peso x Scat. Weight x Box Poids / Bte Gewicht x Krt. Peso x Caja Вес x Кор. Kg	Scat. x Pal. Boxes x Pal. Bte / Pal. Krt. x Pal. Cajas x Pal. Кор. x Подд.	Mq. x Pal. Sqm x Pal. M ² / Pal. Qm x Pal. Mc. x Pal. Кв.М x Подд.	Peso x Pal. Weight x Pal. Poids / Pal. Gewicht x Pal. Peso x Pal. Вес x Подд. Kg
60x120 Naturale	9,5	1,39	2	1,44	31,68	36	51,84	1140
60x60 Naturale	9,5	2,78	3	1,08	23,76	40	43,20	950
30x60 Naturale - Dec. Rome Naturale	9,5	5,56	6	1,08	23,76	48	51,84	1140
7,5x30 Naturale	9,5	44,44	36	0,81	17,82	56	45,36	998
30x30 Mosaico 5X5 Naturale	9,5	11,11	5	0,45	8,73	60	27,00	524
30x30 Mosaico Appia Naturale	9,5	11,11	5	0,45	8,73	60	27,00	524

EXTERNA



PRODUCT CERTIFIED FOR LOW CHEMICAL EMISSIONS:
ULCDM/CG
UL 2818

FORMATI

Sizes | Formats | Formate | Tamaños | Форматы

9,5 mm.

20x40 - 7^{7/8} x 15^{3/4} Naturale

SUPERFICI

Finishes | Finitions | Oberflächen
Superficies | Отделка поверхности

■ NATURALE

R11 DIN 51130

C (A+B+C) DIN 51097

Wet \geq 0,65 DCOF

\geq 0,40 B.C.R.A.

P4 Pendolo AS 4586

> 36 Low Slip potential Pendolo BS 7976

3 Pendolo UNE 41901

SHADE VARIATIONS



V3 HIGH

DESTINAZIONI D'USO

Intended uses | Domaines d'application
Zweckbestimmung | Usos previstos | Назначение



EMILCERAMICA



AVORIO



SABBIA



GRIGIO



EXTERNA

COLORI E FORMATI

Colours and Sizes | Couleurs et Formats | Farben und Formate | Colores y Tamaños | Цвета и Форматы

Avorio



Sabbia



Grigio

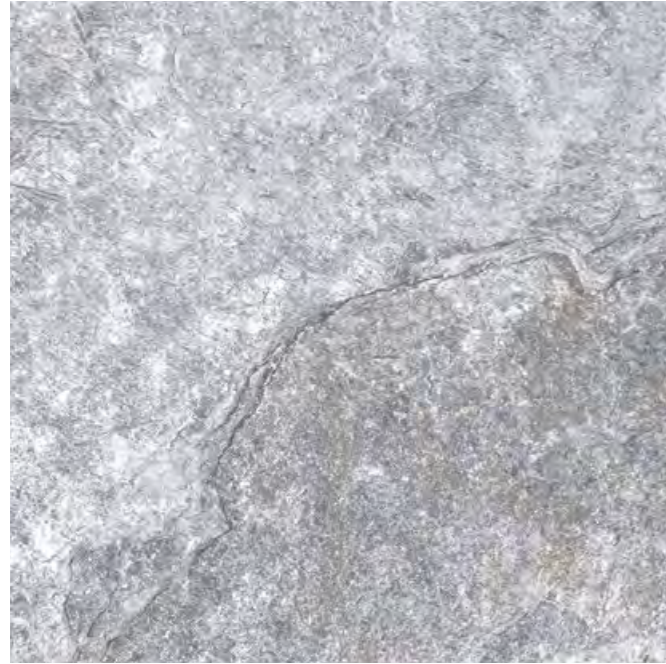

EXTERNA

COLORI E FORMATI

Colours and Sizes | Couleurs et Formats | Farben und Formate | Colores y Tamaños | Цвета и Форматы

 9,5 mm.







Naturale
20x40 - 7^{7/8}"x15^{3/4}"
EEHM Avorio
EEHN Sabbia
EEHP Grigio

● T5
● T5
● T5

Si consiglia la posa con fuga 2 mm. - Laying with a 2 mm-joint is recommended. - Pose recommandée avec joints de 2 mm.
Es wird eine Fugenbreite von 2 mm empfohlen. - Se recomienda la colocación con juntas de 2 mm. - Рекомендуется укладка с швом 2 мм.

PEZZI SPECIALI

Trims | Pieces Speciales | Formteile | Piezas Especiales | Специальные Изделия

	Dimensione Size	 Avorio	 Sabbia	 Grigio	Fascia di prezzo Price band
 Battiscopa - Skirting	Nat. Rett. 7x60 - 2 ^{3/4} "x23 ^{5/8} " Pcs. Box 15 - LM x Box 9,00	EFAJ	EFAK	EFAL	● A11
 Elemento a "L" - L Shaped Piece	Nat. 15x30x3,8 5 ^{7/8} "x11 ^{13/16} "x1 ^{1/2} " Pcs. Box 6 - LM x Box 1,80	EFAC	EFAD	EFAE	● A19

IMBALLI E PESI

Packing and Weight | Emballages et Poids | Verpackung und Gewicht | Embalajes y Pesos | Упаковка и Вес

Formato Size Format Format Tamaño Формат cm	Spessore Thickness Épaisseur Stärke Espesor Толщина mm	Pz. x Mq. Pieces x Sqm Pcs / M ² Stk. x Qm Pzs x Mc. Шт x Кв.М.	Pz. x Scat. Pieces x Box Pcs / Bte Stk. x Krt. Pzs x Caja Шт x Кор.	Mq. x Scat. Sqm x Box M ² / Bte Qm x Krt. Mc. x Caja Кв.М. x Кор.	Peso x Scat. Weight x Box Poids / Bte Gewicht x Krt. Peso x Caja Вес x Кор.	Scat. x Pal. Boxes x Pal. Bte / Pal. Krt. x Pal. Cajas x Pal. Кор. x Подд.	Mq. x Pal. Sqm x Pal. M ² / Pal. Qm x Pal. Mc. x Pal. Кв.М x Подд.	Peso x Pal. Weight x Pal. Poids / Pal. Gewicht x Pal. Peso x Pal. Вес x Подд. Kg
20x40 Naturale	9,5	12,50	12	0,96	21,12	54	51,84	1140

FORMATI

Sizes | Formats | Formate | Tamaños | Форматы

9,5 mm.

20x40 - 7^{7/8} x 15^{3/4} Naturale

SUPERFICI

Finishes | Finitions | Oberflächen
Superficies | Отделка поверхности

NATURALE

R11 DIN 51130

C (A+B+C) DIN 51097

Wet \geq 0,65 DCOF

\geq 0,40 B.C.R.A.

P4 Pendolo AS 4586

> 36 Low Slip potential Pendolo BS 7976

3 Pendolo UNE 41901

SHADE VARIATIONS



V3 HIGH

DESTINAZIONI D'USO

Intended uses | Domaines d'application
Zweckbestimmung | Usos previstos | Назначение



EMILCERAMICA



MATTONE



OCRA

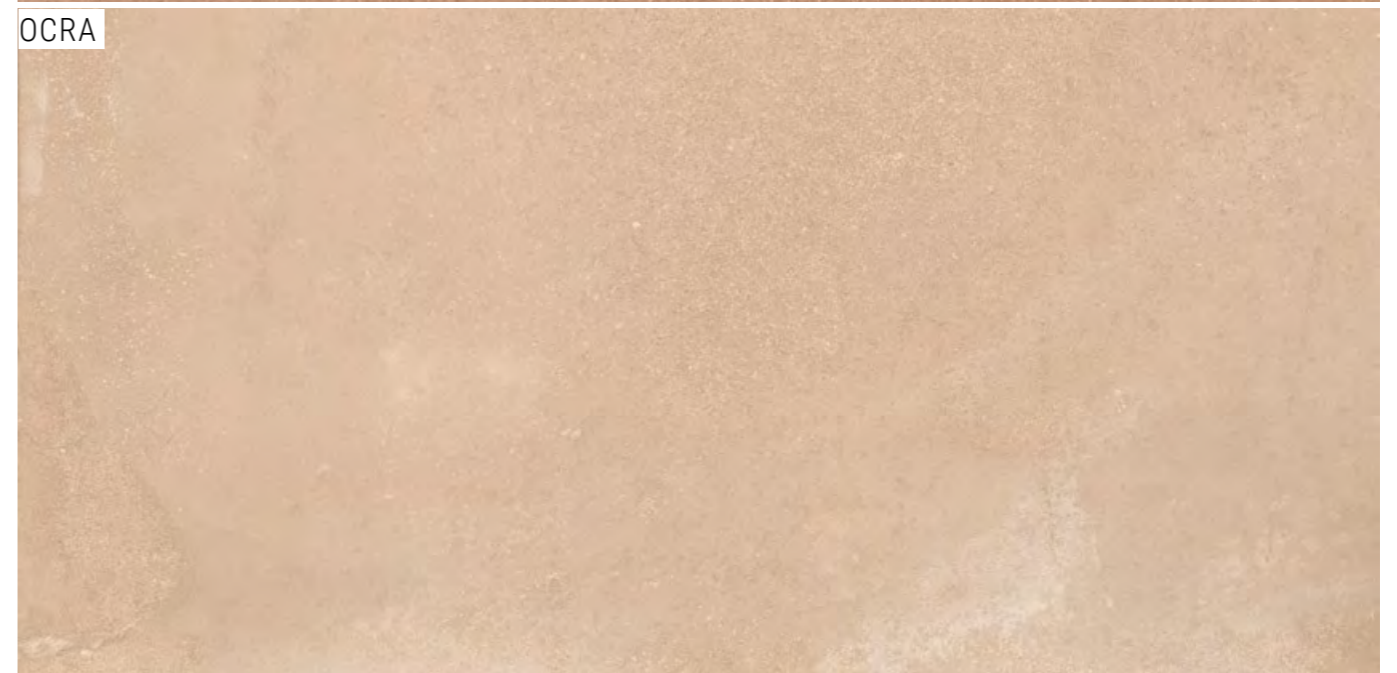

CENERE



EXTERNA COTTO

COLORI E FORMATI

Colours and Sizes | Couleurs et Formats | Farben und Formate | Colores y Tamaños | Цвета и Форматы

Mattone



Ocra



Cenere



EXTERNA COTTO

COLORI E FORMATI

Colours and Sizes | Couleurs et Formats | Farben und Formate | Colores y Tamaños | Цвета и Форматы

 9,5 mm.



Naturale
20x40 - 7^{7/8}"x15^{3/4}"

EGKH Mattone

● T5

EGKK Ocra

● T5





EGKJ Cenere

● T5

Si consiglia la posa con fuga 2 mm. - Laying with a 2 mm-joint is recommended. - Pose recommandée avec joints de 2 mm.
Es wird eine Fugenbreite von 2 mm empfohlen. - Se recomienda la colocación con juntas de 2 mm. - Рекомендуется укладка с швом 2 мм.

PEZZI SPECIALI

Trims | Pieces Speciales | Formteile | Piezas Especiales | Специальные Изделия

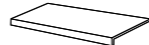
	Dimensione Size	 Mattone	 Ocra	 Cenere	Fascia di prezzo Price band
 Battiscopa - Skirting	Nat. 6x40 - 2 ^{3/8} "x15 ^{3/4} " Pcs. Box 20 - LM x Box 8,00	EGKM	EGKP	EGKN	● A5
 Elemento a "L"- L Shaped Piece	Nat. 15x30x3,8 5 ^{7/8} "x11 ^{13/16} "x1 ^{1/2} " Pcs. Box 6 - LM x Box 1,80	EGKR	EGKT	EGKS	● A19

IMBALLI E PESI

Packing and Weight | Emballages et Poids | Verpackung und Gewicht | Embalajes y Pesos | Упаковка и Вес

Formato Size Format Format Tamaño Формат cm	Spessore Thickness Épaisseur Stärke Espesor Толщина mm	Pz. x Mq. Pieces x Sqm Pcs / M ² Stk. x Qm Pzs x Mc. Шт x Кв.М.	Pz. x Scat. Pieces x Box Pcs / Bte Stk. x Krt. Pzs x Caja Шт x Кор.	Mq. x Scat. Sqm x Box M ² / Bte Qm x Krt. Mc. x Caja Кв.М. x Кор.	Peso x Scat. Weight x Box Poids / Bte Gewicht x Krt. Peso x Caja Вес x Кор.	Scat. x Pal. Boxes x Pal. Bte / Pal. Krt. x Pal. Cajas x Pal. Кор. x Подд.	Mq. x Pal. Sqm x Pal. M ² / Pal. Qm x Pal. Mc. x Pal. Кв.М x Подд.	Peso x Pal. Weight x Pal. Poids / Pal. Gewicht x Pal. Peso x Pal. Вес x Подд. Kg
20x40 Naturale	9,5	12,50	12	0,96	21,12	54	51,84	1140

EXTERNA | QUARZITE



PRODUCT CERTIFIED FOR LOW CHEMICAL EMISSIONS:
ULCDM/CG
UL 2818

FORMATI

Sizes | Formats | Formate | Tamaños | Форматы

 9,5 mm.

20x40 - 7^{7/8} x 15^{3/4}" Naturale

SUPERFICI

Finishes | Finitions | Oberflächen
Superficies | Отделка поверхности

■ NATURALE

R11 DIN 51130

C (A+B+C) DIN 51097

Wet \geq 0,65 DCOF

\geq 0,40 B.C.R.A.

P4 Pendolo AS 4586

> 36 Low Slip potential Pendolo BS 7976

3 Pendolo UNE 41901

SHADE VARIATIONS



V3 HIGH

DESTINAZIONI D'USO

Intended uses | Domaines d'application
Zweckbestimmung | Usos previstos | Назначение



EMILCERAMICA

GOLD GREY



RUST GREY



EXTERNA QUARZITE

COLORI E FORMATI

Colours and Sizes | Couleurs et Formats | Farben und Formate | Colores y Tamaños | Цвета и Форматы

Gold Grey



Rust Grey



EXTERNA QUARZITE

COLORI E FORMATI

Colours and Sizes | Couleurs et Formats | Farben und Formate | Colores y Tamaños | Цвета и Форматы

9,5 mm.



Naturale

20x40 - 7^{7/8}"x15^{3/4}"

EGL1 Gold Grey

● **T5**

EGL2 Rust Grey

● **T5**

Si consiglia la posa con fuga 2 mm. - Laying with a 2 mm-joint is recommended. - Pose recommandée avec joints de 2 mm.
Es wird eine Fugenbreite von 2 mm empfohlen. - Se recomienda la colocación con juntas de 2 mm. - Рекомендуется укладка с швом 2 мм.

PEZZI SPECIALI

Trims | Pieces Speciales | Formteile | Piezas Especiales | Специальные Изделия

	Dimensione Size			Fascia di prezzo Price band
 Battiscopa - Skirting	Nat. 6x40 - 2 ^{3/8} "x15 ^{3/4} " Pcs. Box 20 - LM x Box 8	EGL4	EGL5	● A5
 Elemento a "L" - L Shaped Piece	Nat. 15x30x3,8 5 ^{7/8} "x1 ^{13/16} "x1 ^{1/2} " Pcs. Box 6 - LM x Box 1,80	EGL7	EGL8	● A19

IMBALLI E PESI

Packing and Weight | Emballages et Poids | Verpackung und Gewicht | Embalajes y Pesos | Упаковка и Вес

Formato Size Format Format Тamaño Формат cm	Spessore Thickness Épaisseur Stärke Espesor Толщина mm	Pz. x Mq. Pieces x Sqm Pcs / M ² Stk. x Qm Pzs x Mc. Шт x Кв.М.	Pz. x Scat. Pieces x Box Pcs / Bte Stk. x Krt. Pzs x Caja Шт x Кор.	Mq. x Scat. Sqm x Box M ² / Bte Qm x Krt. Mc. x Caja Кв.М. x Кор.	Peso x Scat. Weight x Box Poids / Bte Gewicht x Krt. Peso x Caja Вес x Кор.	Scat. x Pal. Boxes x Pal. Bte / Pal. Krt. x Pal. Cajas x Pal. Кор. x Подд.	Mq. x Pal. Sqm x Pal. M ² / Pal. Qm x Pal. Mc. x Pal. Кв.М x Подд.	Peso x Pal. Weight x Pal. Poids / Pal. Gewicht x Pal. Peso x Pal. Вес x Подд. Kg
20x40 Naturale	9,5	12,50	12	0,96	21,12	54	51,84	1140

Kotto



PRODUCT CERTIFIED FOR LOW CHEMICAL EMISSIONS: ULCDM/CG UL 2818

FORMATI

Sizes | Formats | Formate | Tamaños | Форматы

9,5 mm.

80x80 - 31^{1/2}"x31^{1/2}" Naturale

40x80 - 15^{3/4}"x31^{1/2}" Naturale

60x60 - 23^{5/8}"x23^{5/8}" Naturale - Antislip

30x60 - 11^{13/16}"x23^{5/8}" Naturale

9 mm.

12,5x25 - 4^{15/16}"x9^{13/16}" Brick Naturale

6x25 - 2^{3/8}"x9^{13/16}" Brick Naturale

SUPERFICI

Finishes | Finitions | Oberflächen
Superficies | Отделка поверхности

NATURALE

R10 DIN 51130

B (A+B) DIN 51097

Wet \geq 0,50 DCOF

\geq 0,40 B.C.R.A.

P2 Pendolo AS 4586

< 36 Moderate Slip potential Pendolo BS 7976

2 Pendolo UNE 41901

BRICK NATURALE | ANTISLIP

R11 DIN 51130

C (A+B+C) DIN 51097

Wet \geq 0,65 DCOF

\geq 0,40 B.C.R.A.

P2 Pendolo AS 4586

> 36 Low Slip potential Pendolo BS 7976

2 Pendolo UNE 41901

SHADE VARIATIONS



V3 HIGH

DESTINAZIONI D'USO

Intended uses | Domaines d'application
Zweckbestimmung | Usos previstos | Назначение



12% 9,5 mm
0% 9 mm



GESSO (solo 6x25 e 12,5x25)

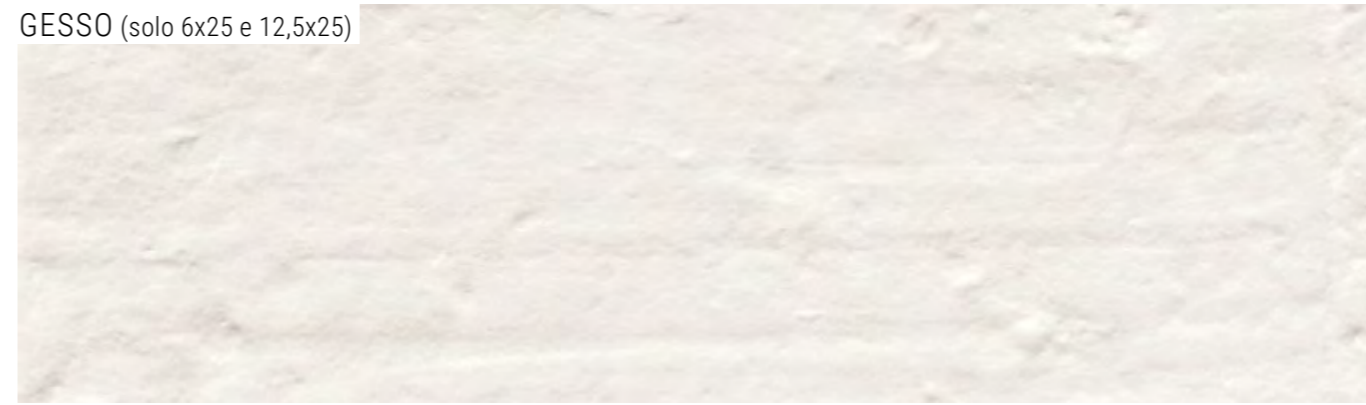

CALCE



AVANA

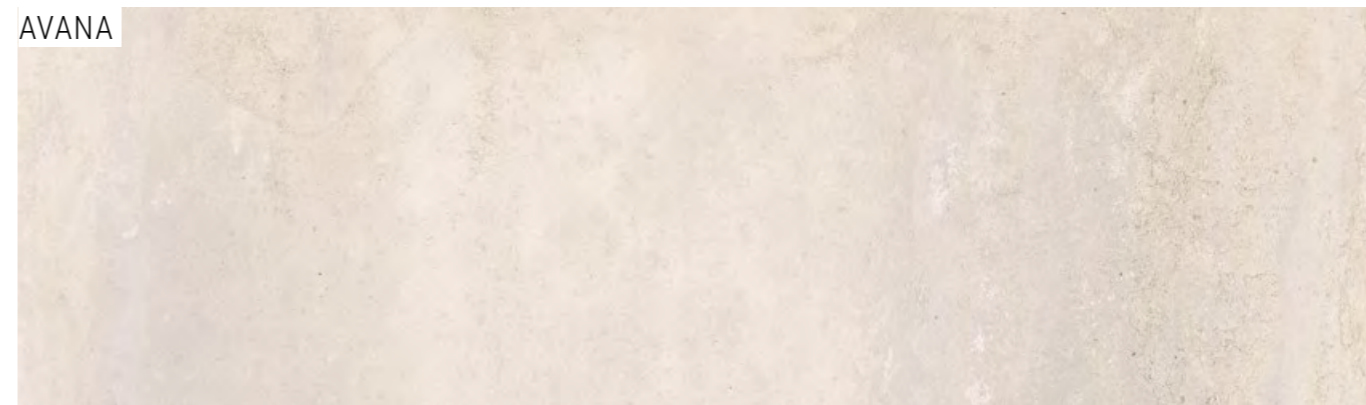

TERRA

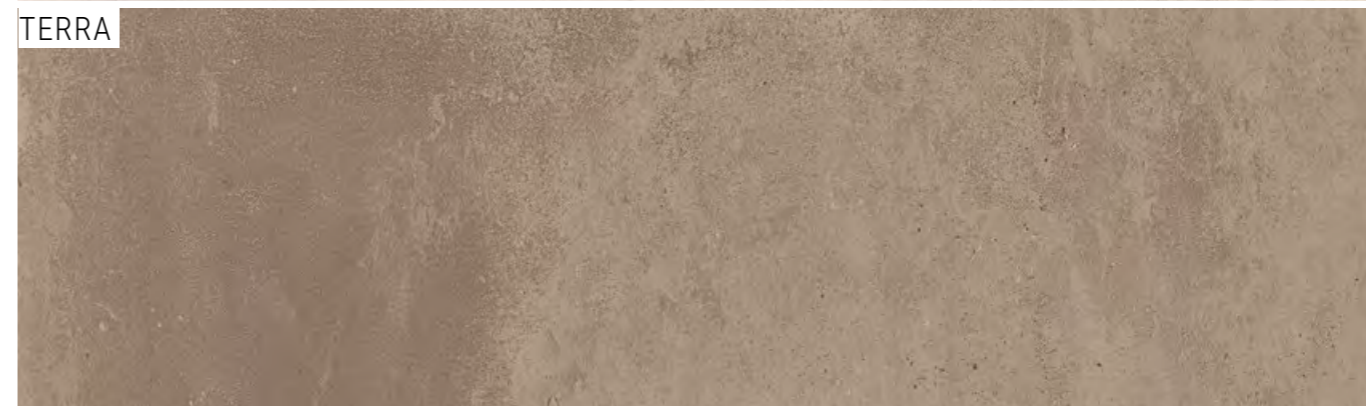

CENERE

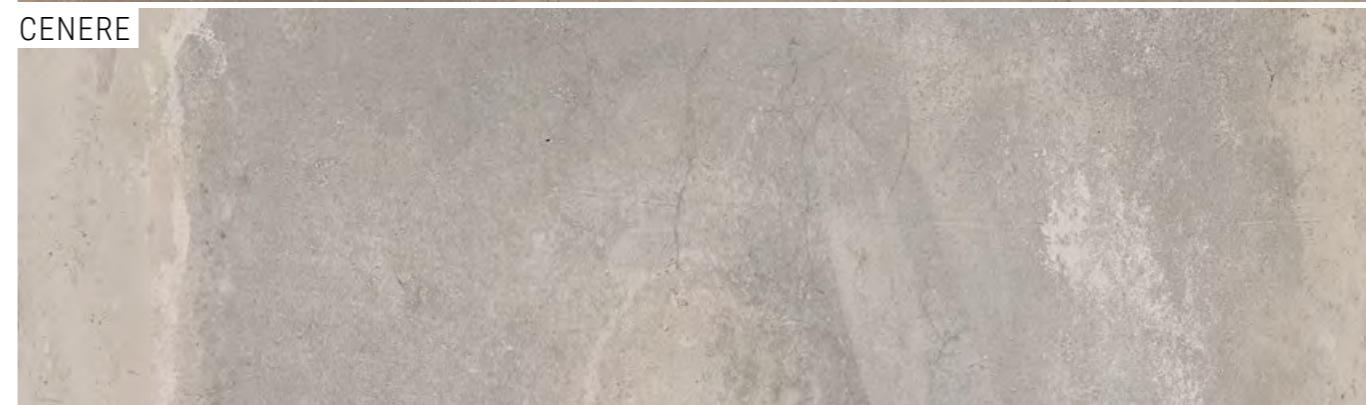

COLORI E FORMATI

Colours and Sizes | Couleurs et Formats | Farben und Formate | Colores y Tamaños | Цвета и Форматы

Gesso (solo 6x25 e 12,5x25)

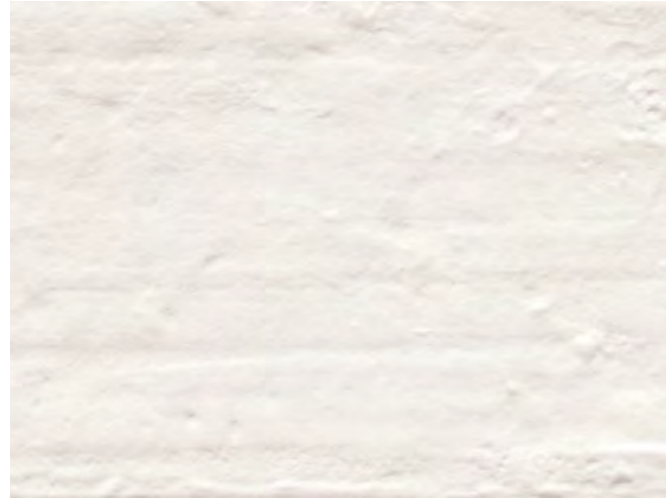

Calce



Avana



Terra

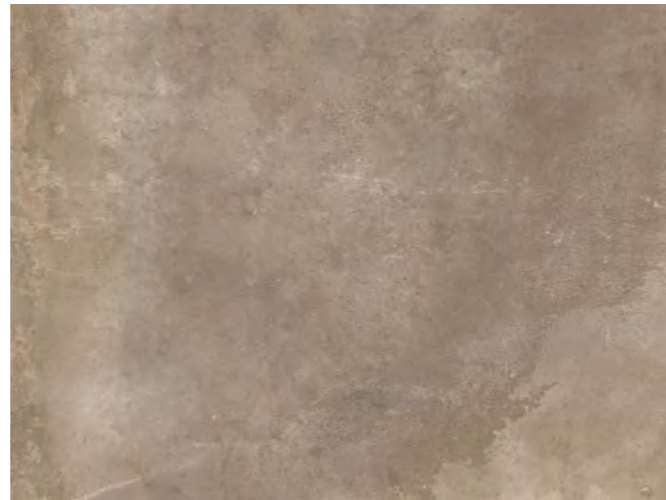

Cenere



COLORI E FORMATI

Colours and Sizes | Couleurs et Formats | Farben und Formate | Colores y Tamaños | Цвета и Форматы

9,5 mm. Kotto XL



Naturale Rett.

80x80 - 31^{1/2}x31^{1/2}"

- E30N Calce ● T25
- E30D Avana ● T25
- E30E Terra ● T25
- E30F Cenere ● T25



Naturale Rett.

40x80 - 15^{3/4}x31^{1/2}"

- E325 Calce ● T23
- E327 Avana ● T23
- E328 Terra ● T23
- E329 Cenere ● T23

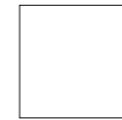

Naturale Rett.

60x60 - 23^{5/8}x23^{5/8}"

- E30L Calce ● T17
- E304 Avana ● T17
- E305 Terra ● T17
- E306 Cenere ● T17

Antislip Rett.

60x60 - 23^{5/8}x23^{5/8}"

- E3GW Avana ● T17
- E3GX Cenere ● T17

9,5 mm. Kotto XS



Naturale Rett.

30x60 - 11^{13/16}x23^{5/8}"

- E30M Calce ● T14
- E308 Avana ● T14
- E309 Terra ● T14
- E30A Cenere ● T14

9 mm. Kotto Brick



Brick Naturale

12,5x25 - 4^{15/16}x9^{13/16}"

- E2ZU Gesso ● T12
- E30J Calce ● T12
- E2ZW Avana ● T12



Brick Naturale

6x25 - 2^{3/8}x9^{13/16}"

- E30W Gesso ● T12
- E30X Calce ● T12
- E30Z Avana ● T12
- E310 Terra ● T12
- E311 Cenere ● T12

Si consiglia la posa con fuga 2 mm. - Laying with a 2 mm-joint is recommended. - Pose recommandée avec joints de 2 mm.
Es wird eine Fugenbreite von 2 mm empfohlen. - Se recomienda la colocación con juntas de 2 mm. - Рекомендуется укладка с швом 2 мм.

Verificare l'abbinamento dei toni tra i formati differenti. - Check the colour matching between different sizes.
Vérifier l'assortiment des tonalités entre les différents formats. - Die Kombination der Farbtöne unter den verschiedenen Formaten prüfen.
Comprobar la combinación de los tonos entre los distintos formatos. - Проверьте сочетание тонов у разных форматов.

KOTTO

DECORI

Decors | Decors | Dekore | Decorados | Декоры

DEKÒ ART KOTTO XL



20x20 - 7^{7/8}"x7^{7/8}"

E51C Calce Nat. Rett.

● T94



20x20 - 7^{7/8}"x7^{7/8}"

E32S Avana Nat. Rett.

● T94



20x20 - 7^{7/8}"x7^{7/8}"

E7PU Terra Nat. Rett.

● T94

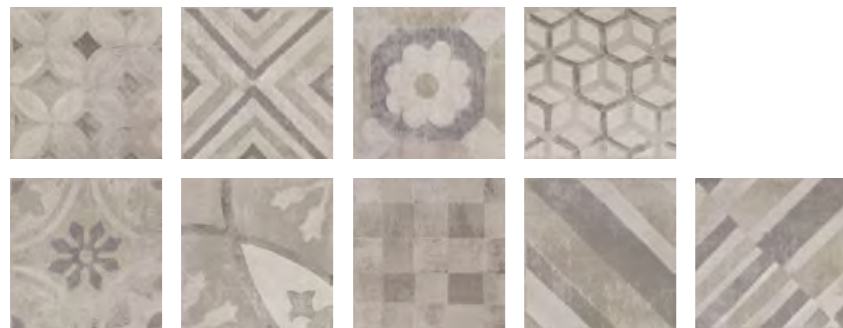

20x20 - 7^{7/8}"x7^{7/8}"

E7PW Cenere Nat. Rett.

● T94

KOTTO

DECORI

Decors | Decors | Dekore | Decorados | Декоры

MOSAICO 5X5* KOTTO XL

Tessera - Chip 4,8x4,8 - 1^{7/8}"x1^{7/8}"

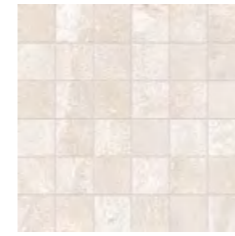

30x30 - 11^{13/16}"x11^{13/16}"

E344 Calce Nat. ● A86

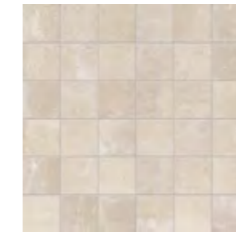

30x30 - 11^{13/16}"x11^{13/16}"

E346 Avana Nat. ● A86

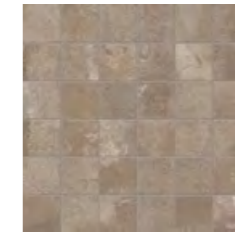

30x30 - 11^{13/16}"x11^{13/16}"

E347 Terra Nat. ● A86



30x30 - 11^{13/16}"x11^{13/16}"

E348 Cenere Nat. ● A86

MOSAICO 5X5* KOTTO XS

Tessera - Chip 4,8x4,8 - 1^{7/8}"x1^{7/8}"

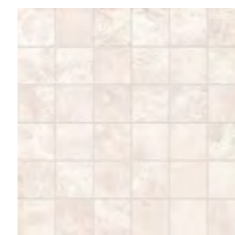

30x30 - 11^{13/16}"x11^{13/16}"

E312 Calce Nat. ● A86

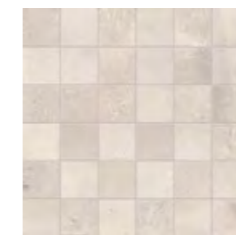

30x30 - 11^{13/16}"x11^{13/16}"

E314 Avana Nat. ● A86

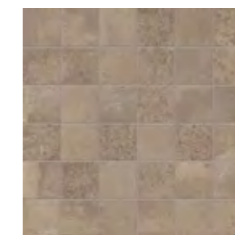

30x30 - 11^{13/16}"x11^{13/16}"

E315 Terra Nat. ● A86



30x30 - 11^{13/16}"x11^{13/16}"

E316 Cenere Nat. ● A86

* Su rete in fibra - On fibre mesh backing - Sur filet en fibre de verre - Auf Glasfasernetz - Sobre malla de fibra - На волоконной сетке

PEZZI SPECIALI KOTTO XL

Trims | Pieces Speciales | Formteile | Piezas Especiales | Специальные Изделия

	Dimensione Size					Fascia di prezzo Price band
 Battiscopa - Skirting	Nat. Rett. 7x60 - 2 ^{3/4} x23 ^{5/8} " Pcs. Box 15 - LM x Box 9,00	E317	E319	E31A	E31C	● A11
	Nat. Rett. 4,6x60 - 1 ^{13/16} x23 ^{5/8} " Pcs. Box 20 - LM x Box 12	E3AH	E3AK	E3AL	E9LF	● A11
 Gradino - Stair Tread	Nat. Rett. 33x60 - 12 ^{15/16} x23 ^{5/8} " Pcs. Box 6 - LM x Box 3,60	E9AW	E9AY	E9AZ	E9C0	● A54
 Gradone - Step	Nat. Rett. 33x60x3,2x3,2 12 ^{15/16} x23 ^{5/8} x1 ^{1/4} x1 ^{1/4} " Pcs. Box 4 - LM x Box 2,40	E9AF	E9AH	E9AJ	E9AK	● A68
 Angolare - Corner Tile	Nat. Rett. 33x33x3,2x3,2 12 ^{15/16} x12 ^{15/16} x1 ^{1/4} x1 ^{1/4} " Pcs. Box 2 - LM x Box 0,66	E9A9	E9AC	E9AD	E9AE	● A72
 Elemento a "L" - L Shaped Piece	Nat. Rett. 15x60x5 5 ^{7/8} x23 ^{5/8} x1 ^{15/16} " Pcs. Box 4 - LM x Box 2,40	E31H	E31K	E31L	E31M	● A34

PEZZI SPECIALI KOTTO XS

Trims | Pieces Speciales | Formteile | Piezas Especiales | Специальные Изделия

	Dimensione Size					Fascia di prezzo Price band
 Battiscopa - Skirting	Nat. Rett. 7x60 - 2 ^{3/4} x23 ^{5/8} " Pcs. Box 15 - LM x Box 9,00	E3DE	E3DG	E3DH	E9MH	● A11
	Nat. Rett. 4,6x60 - 1 ^{13/16} x23 ^{5/8} " Pcs. Box 20 - LM x Box 12	E3AM	E3AP	E3AQ	E3AR	● A11
 Gradino - Stair Tread	Nat. Rett. 30x60 - 11 ^{13/16} x23 ^{5/8} " Pcs. Box 6 - LM x Box 3,60	E9C1	E9C3	E9C4	E9C5	● A44
 Gradone - Step	Nat. Rett. 30x60x3,2x3,2 11 ^{13/16} x23 ^{5/8} x1 ^{1/4} x1 ^{1/4} " Pcs. Box 4 - LM x Box 2,40	E9AR	E9AT	E9AU	E9AV	● A58
 Angolare - Corner Tile	Nat. Rett. 30x30x3,2x3,2 11 ^{13/16} x11 ^{13/16} x1 ^{1/4} x1 ^{1/4} " Pcs. Box 2 - LM x Box 0,60	E9AL	E9AN	E9AP	E9AQ	● A66
 Elemento a "L" - L Shaped Piece	Nat. Rett. 15x60x5 5 ^{7/8} x23 ^{5/8} x1 ^{15/16} " Pcs. Box 4 - LM x Box 2,40	E31H	E31K	E31L	E31M	● A34

PEZZI SPECIALI KOTTO BRICK

Trims | Pieces Speciales | Formteile | Piezas Especiales | Специальные Изделия

	Dimensione Size						Fascia di prezzo Price band
 Brick Angolare - Brick Corner	Nat. (AxBxC) 12,5x19x6 4 ^{15/16} x7 ^{1/2} x2 ^{3/8} " Pcs. Box 6	E9FT	E9FU	E9FW	-	-	● A19
 Brick Angolare - Brick Corner	Nat. (AxBxC) 6x25x12,5 2 ^{3/8} x9 ^{13/16} x4 ^{15/16} " Pcs. Box 12	E38X	E38Y	E390	E391	E9FS	● A19
 Becco Civetta - Bullnose	Nat. 6x25 - 2 ^{3/8} x9 ^{13/16} " Pcs. Box 34	E396	E377	E378	E9EZ	E379	● A4
 Cove Base*	Nat. 16x30 - 6 ^{5/16} x11 ^{13/16} " Pcs. Box 30	E9GF	E9C6	E31E	E31F	E31G	● A22
 Cove Base Ang. Int.* Cove Base In Corner	Nat. 2,5x16 - 15 ^{1/16} x6 ^{5/16} " Pcs. Box 10	E9FZ	E9C7	E31U	E31V	E31W	● A16
 Cove Base Ang. Est.* Cove Base Out Corner	Nat. 2,5x16 - 15 ^{1/16} x6 ^{5/16} " Pcs. Box 10	E9FY	E31N	E31Q	E31R	E31S	● A16

*Ordine minimo 500 pezzi - Minimum order: 500 pieces - Commande minimale 500 pièces
Mindestbestellmenge 500 Stücke - Pedido mínimo 500 piezas - Минимальный заказ - 500 штук

IMBALLI E PESI

Packing and Weight | Emballages et Poids | Verpackung und Gewicht | Embalajes y Pesos | Упаковка и Вес

Formato Size Format Format Tamaño Формат cm	Spessore Thickness Epaisseur Stärke Espesor Толщина mm	Pz. x Mq. Pieces x Sqm Pcs / M ² Stk. x Qm Pzs x Mc. Шт x Кв.М.	Pz. x Scat. Pieces x Box Pcs / Bte Stk. x Krt. Pzs x Caja Шт x Кор.	Mq. x Scat. Sqm x Box M ² / Bte Qm x Krt. Кв.М. x Кор.	Peso x Scat. Weight x Box Poids / Bte Gewicht x Krt. Peso x Caja Вес x Кор. Kg	Scat. x Pal. Boxes x Pal. Bte / Pal. Krt. x Pal. Cajas x Pal. Кор. x Подд.	Mq. x Pal. Sqm x Pal. M ² / Pal. Qm x Pal. Кв.М x Подд.	Peso x Pal. Weight x Pal. Poids / Pal. Gewicht x Pal. Peso x Pal. Вес x Подд. Kg
80x80 Naturale	9,5	1,56	2	1,28	28,16	42	53,76	1183
40x80 Naturale	9,5	3,13	3	0,96	21,12	28	26,88	591
60x60 Naturale - Antislip	9,5	2,78	3	1,08	23,76	40	43,20	950
30x60 Naturale	9,5	5,56	6	1,08	23,76	48	51,84	1140
12,5x25 Naturale	9	32,00	26	0,81	12,50	81	65,61	1013
6x25 Naturale	9	66,67	34	0,51	9,57	99	50,49	947
30x30 Mosaico 5X5 XL Naturale	9,5	11,11	5	0,45	8,73	60	27,00	524
30x30 Mosaico 5X5 XS Naturale	9,5	11,11	5	0,45	8,73	60	27,00	524
20x20 Dekò Naturale	9,5	25,00	18	0,68	15,84	72	48,96	1140

LANDSCAPE



FORMATI

Sizes | Formats | Formate | Tamaños | Форматы

9,5 mm. 60x120 - 23^{5/8}"x47^{1/4}" Silktech
80x80 - 31^{1/2}"x31^{1/2}" Silktech
40x80 - 15^{3/4}"x31^{1/2}" Silktech
60x60 - 23^{5/8}"x23^{5/8}" Silktech
30x60 - 11^{13/16}"x23^{5/8}" Silktech
OPUS Silktech

20MM 80x80 - 31^{1/2}"x31^{1/2}" Naturale

SUPERFICI

Finishes | Finitions | Oberflächen
Superficies | Отделка поверхности

SILKTECH

R10 DIN 51130
B (A+B) DIN 51097
Wet ≥ 0,50 DCOF
≥ 0,40 B.C.R.A.
P3 Pendolo AS 4586
> 36 Low Slip potential Pendolo BS 7976
2 Pendolo UNE 41901

20MM

R11 DIN 51130
C (A+B+C) DIN 51097
Wet ≥ 0,65 DCOF
≥ 0,40 B.C.R.A.
P4 Pendolo AS 4586
> 36 Low Slip potential Pendolo BS 7976
3 Pendolo UNE 41901

SHADE VARIATIONS



V3 HIGH

DESTINAZIONI D'USO

Intended uses | Domaines d'application
Zweckbestimmung | Usos previstos | Назначение



20% 20MM
12% 40x80 - 80x80
0% 30x60 - 60x60 - 60x120



AVORIO

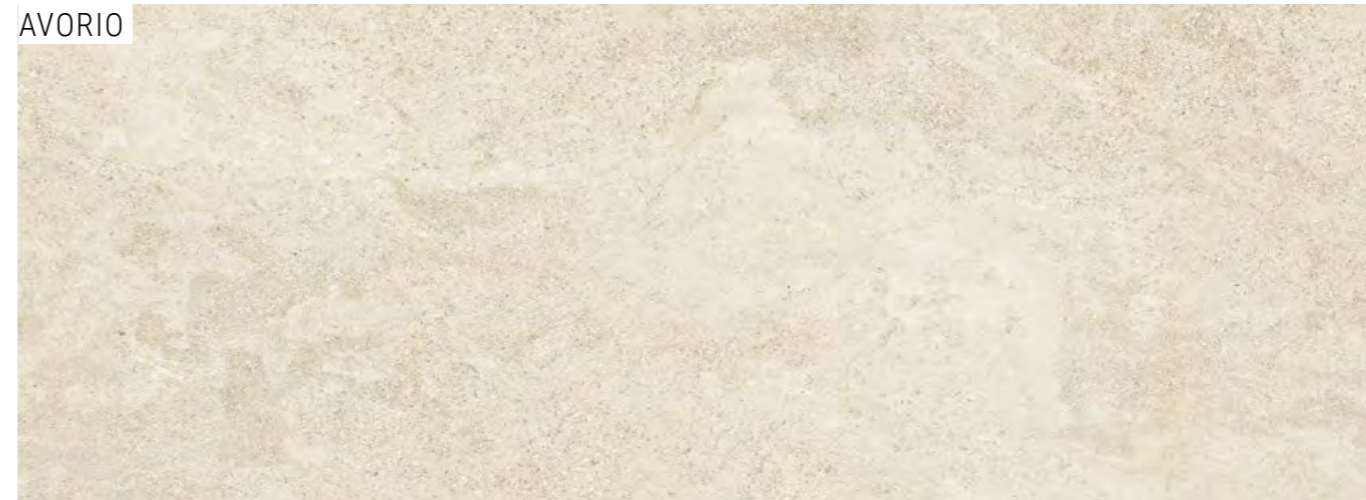

SABBIA



CENERE



ANTRACITE



LANDSCAPE

COLORI E FORMATI

Colours and Sizes | Couleurs et Formats | Farben und Formate | Colores y Tamaños | Цвета и Форматы

Avorio



Sabbia



Cenere



Antracite



Si consiglia la posa con fuga 2 mm. - Laying with a 2 mm-joint is recommended. - Pose recommandée avec joints de 2 mm.
Es wird eine Fugenbreite von 2 mm empfohlen. - Se recomienda la colocación con juntas de 2 mm. - Рекомендуется укладка с швом 2 мм.

LANDSCAPE

COLORI E FORMATI

Colours and Sizes | Couleurs et Formats | Farben und Formate | Colores y Tamaños | Цвета и Форматы

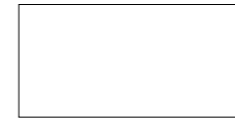

Silktech Rett.
60x120 - 23^{5/8}"x47^{1/4}"
EJRE Avorio
EJRF Sabbia
EJRG Cenere
EJRH Antracite

- T31
- T31
- T31
- T31



Silktech Rett.
80x80 - 31^{1/2}"x31^{1/2}"
EJR8 Avorio
EJR9 Sabbia
EJRA Cenere
EJRC Antracite

- T25
- T25
- T25
- T25



Silktech Rett.
40x80 - 15^{3/4}"x31^{1/2}"
EJX2 Avorio
EJX3 Sabbia
EJX4 Cenere
EJX5 Antracite

- T23
- T23
- T23
- T23



Silktech Rett.
60x60 - 23^{5/8}"x23^{5/8}"
EJRK Avorio
EJRL Sabbia
EJRM Cenere
EJRN Antracite

- T17
- T17
- T17
- T17



Silktech Rett.
30x60 - 11^{13/16}"x23^{5/8}"
EJRQ Avorio
EJRR Sabbia
EJRS Cenere
EJRT Antracite

- T14
- T14
- T14
- T14



1 pz./pcs 20x30 - 7^{7/8}"x11^{13/16}"
1 pz./pcs 20x20 - 7^{7/8}"x7^{7/8}"

OPUS

Silktech Brecciato
EJYF Avorio
EJYG Sabbia
EJYH Cenere
EJYJ Antracite

- T115
- T115
- T115
- T115



Naturale Rett.
80x80 - 31^{1/2}"x31^{1/2}"
EJS2 Sabbia
EJS3 Cenere
EJS4 Antracite

- T67
- T67
- T67



La tecnologia Silktech combina prestazioni antiscivolo elevate e una superficie ceramica setosa al tatto.

The Silktech technology combines excellent anti-slip performances with a ceramic surface that's silky to the touch.

Verificare l'abbinamento dei toni tra i formati differenti. - Check the colour matching between different sizes.
Vérifier l'assortiment des tonalités entre les différents formats. - Die Kombination der Farbtöne unter den verschiedenen Formaten prüfen.
Comprobar la combinación de los tonos entre los distintos formatos. - Проверьте сочетание тонов у разных форматов.

LANDSCAPE

DECORI

Decors | Decors | Dekore | Decorados | Декоры

DECORO RIGATO



60x120 - 23^{5/8}"x47^{1/4}"
EJRJ Rigato Avorio Silktech Rett.

● T37



60x120 - 23^{5/8}"x47^{1/4}"
EJRW Rigato Sabbia Silktech Rett.

● T37

LANDSCAPE

DECORI

Decors | Decors | Dekore | Decorados | Декоры

DECORO RIGATO



60x120 - 23^{5/8}"x47^{1/4}"
EJRZ Rigato Cenere Silktech Rett.

● T37



60x120 - 23^{5/8}"x47^{1/4}"
EJRZ Rigato Antracite Silktech Rett.

● T37

LANDSCAPE

DECORI

Decors | Decors | Dekore | Decorados | Декоры

LISTELLI SFALSATI*



30x60 - 11^{13/16}"x23^{5/8}"
EJX7 Avorio Silktech ● A80



30x60 - 11^{13/16}"x23^{5/8}"
EJX8 Sabbia Silktech ● A80

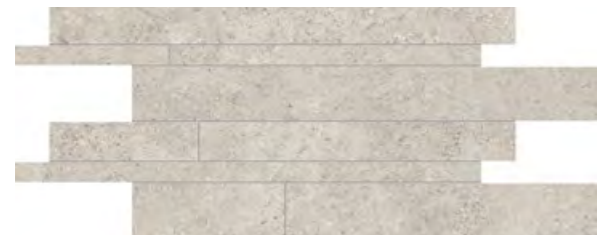

30x60 - 11^{13/16}"x23^{5/8}"
EJX9 Cenere Silktech ● A80



30x60 - 11^{13/16}"x23^{5/8}"
EJXA Antracite Silktech ● A80

MOSAICO MURETTO*



30x45 - 11^{13/16}"x17^{11/16}"
EJYQ Avorio Silktech ● A96



30x45 - 11^{13/16}"x17^{11/16}"
EJYR Sabbia Silktech ● A96



30x45 - 11^{13/16}"x17^{11/16}"
EJYS Cenere Silktech ● A96



30x45 - 11^{13/16}"x17^{11/16}"
EJYT Antracite Silktech ● A96

MOSAICO 5X5*

Tessera - Chip 4,8x4,8 - 1^{7/8}"x1^{7/8}"

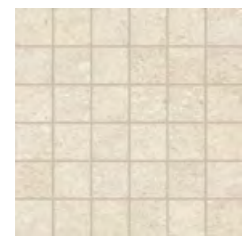

30x30 - 11^{13/16}"x11^{13/16}"
EJXD Avorio Silktech ● A86



30x30 - 11^{13/16}"x11^{13/16}"
EJXE Sabbia Silktech ● A86



30x30 - 11^{13/16}"x11^{13/16}"
EJXF Cenere Silktech ● A86





30x30 - 11^{13/16}"x11^{13/16}"
EJXG Antracite Silktech ● A86

* Su rete in fibra - On fibre mesh backing - Sur filet en fibre de verre - Auf Glasfasernetz - Sobre malla de fibra - На волоконной сетке

LANDSCAPE

PEZZI SPECIALI

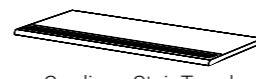
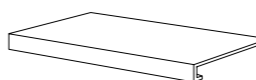
Trims | Pieces Speciales | Formteile | Piezas Especiales | Специальные Изделия

	Dimensione Size	Avorio	Sabbia	Cenere	Antracite	Fascia di prezzo Price band
 Battiscopa - Skirting	SilkTech Rett. 7x60 - 2 ^{3/4} "x23 ^{5/8} " Pcs. Box. 15 - LM x Box 9,00	EJXJ	EJXK	EJXL	EJXM	● A11
	SilkTech Rett. 4,6x80 - 1 ^{13/16} "x31 ^{1/2} " Pcs. Box 12 - LM x Box 9,60	EJXP	EJXQ	EJXR	EJXS	● A16
 Gradino - Stair Tread	SilkTech Rett. 33x120 - 12 ^{15/16} "x47 ^{1/4} " Pcs. Box 2 - LM x Box 2,40	EJXU	EJXV	EJXW	EJXX	● A82
 Gradone - Step	SilkTech Rett. 33x120x3,2x3,2 12 ^{15/16} "x47 ^{1/4} "x1 ^{1/4} "x1 ^{1/4} " Pcs. Box 2 - LM x Box 2,40	EJXZ	EJY0	EJY1	EJY2	● A98
 Angolare Dx Sx Corner Tile Dx Sx	SilkTech Rett. 33x120x3,2x3,2 12 ^{15/16} "x47 ^{1/4} "x1 ^{1/4} "x1 ^{1/4} " Pcs. Box 1 - LM x Box 1,20	DX EJY4	DX EJY5	DX EJY6	DX EJY7	● A104
		SX EJY9	SX EJYA	SX EJYC	SX EJYD	

Pezzi speciali 20mm su richiesta - 20mm trims available on request - Pièces spéciales 20mm (sur demande) - Formteile 20mm auf anfrage erhältlich - Piezas especiales 20mm disponibles bajo pedido - Специальные изделия 20мм по запросу

IMBALLI E PESI

Packing and Weight | Emballages et Poids | Verpackung und Gewicht | Embalajes y Pesos | Упаковка и Вес

Formato Size Format Format Tamaño Формат cm	Spessore Thickness Epaisseur Stärke Espesor Толщина mm	Pz. x Mq. Pieces x Sqm Pcs / M ² Stk. x Qm Pzs x Mc. Шт x Кв.М.	Pz. x Scat. Pieces x Box Pcs / Bte Stk. x Krt. Pzs x Caja Шт x Кор.	Mq. x Scat. Sqm x Box M ² / Bte Qm x Krt. Mc. x Caja Кв.М. x Кор.	Peso x Scat. Weight x Box Poids / Bte Gewicht x Krt. Peso x Caja Вес x Кор. Kg	Scat. x Pal. Boxes x Pal. Bte / Pal. Krt. x Pal. Cajas x Pal. Кор. x Подд.	Mq. x Pal. Sqm x Pal. M ² / Pal. Qm x Pal. Mc. x Pal. Кв.М x Подд.	Peso x Pal. Weight x Pal. Poids / Pal. Gewicht x Pal. Peso x Pal. Вес x Подд. Kg
80x80 Silktech	9,5	1,56	2	1,28	28,16	42	53,76	1183
40x80 Silktech	9,5	3,13	3	0,96	21,12	28	26,88	591
60x120 Silktech	9,5	1,39	2	1,44	31,68	36	51,84	1140
60x60 Silktech	9,5	2,78	3	1,08	23,76	40	43,20	950
30x60 Silktech	9,5	5,56	6	1,08	23,76	48	51,84	1140
60x120 Dec. Rigato Silktech	9,5	1,39	2	1,44	31,68	36	51,84	1140
30x60 Listelli Sfalsati Silktech	9,5	5,56	4	0,72	15,80	30	21,60	474
30x45 Mosaico Muretto Silktech	9,5	7,41	5	0,68	15,20	40	27,00	608
30x30 Mosaico Silktech	9,5	11,11	5	0,45	8,73	60	27,00	524
OPUS Brecciato Silktech	9,5	-	12	0,60	14,20	54	32,40	767
80x80 Naturale 20MM	20	1,56	1	0,64	29,44	45	28,80	1325

MILLELEGGNI



PRODUCT CERTIFIED FOR LOW CHEMICAL EMISSIONS: ULCDM/CG UL 2818

FORMATI

Sizes | Formats | Formate | Tamaños | Форматы

9,5 mm.

30x120 - 11^{13/16}"x47^{1/4}" Naturale

20x120 - 7^{7/8}"x47^{1/4}" Naturale

15x120 - 5^{7/8}"x47^{1/4}" Naturale

20MM

40x120 - 15^{3/4}"x47^{1/4}" Naturale

SUPERFICI

Finishes | Finitions | Oberflächen
Superficies | Отделка поверхности

NATURALE

R10 DIN 51130

B (A+B) DIN 51097

Wet \geq 0,50 DCOF

\geq 0,40 B.C.R.A.

P2 Pendolo AS 4586

< 36 High Slip potential Pendolo BS 7976

- Pendolo UNE 41901

20MM

R11 DIN 51130

C (A+B+C) DIN 51097

Wet \geq 0,65 DCOF

\geq 0,40 B.C.R.A.

P4 Pendolo AS 4586

> 36 Low Slip potential Pendolo BS 7976

3 Pendolo UNE 41901

SHADE VARIATIONS



V3 HIGH



Noce Selvatico



V4 RANDOM

DESTINAZIONI D'USO

Intended uses | Domaines d'application
Zweckbestimmung | Usos previstos | Назначение



12%
20% 20MM



UPEC-F+

20MM



001 WHITE TOULPIER



002 SCOTTISH OAK



003 NOCE SELVATICO

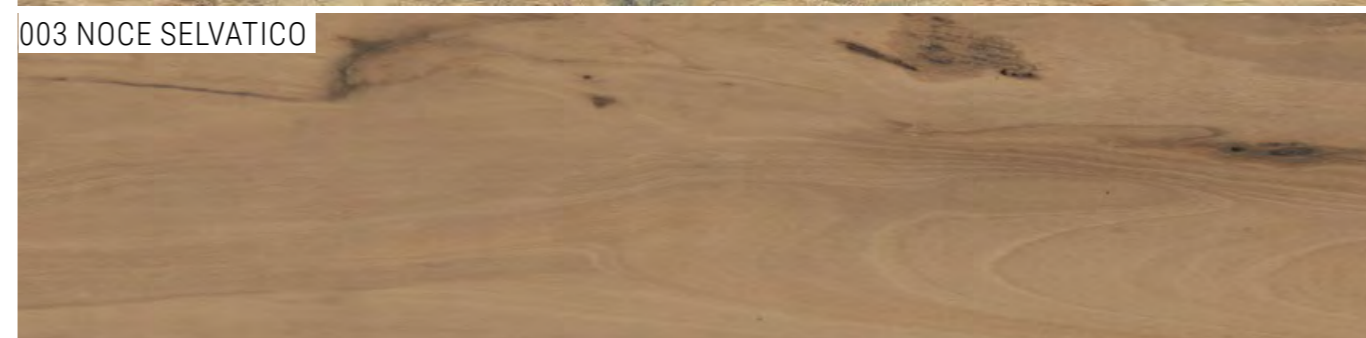

004 GREY ASH

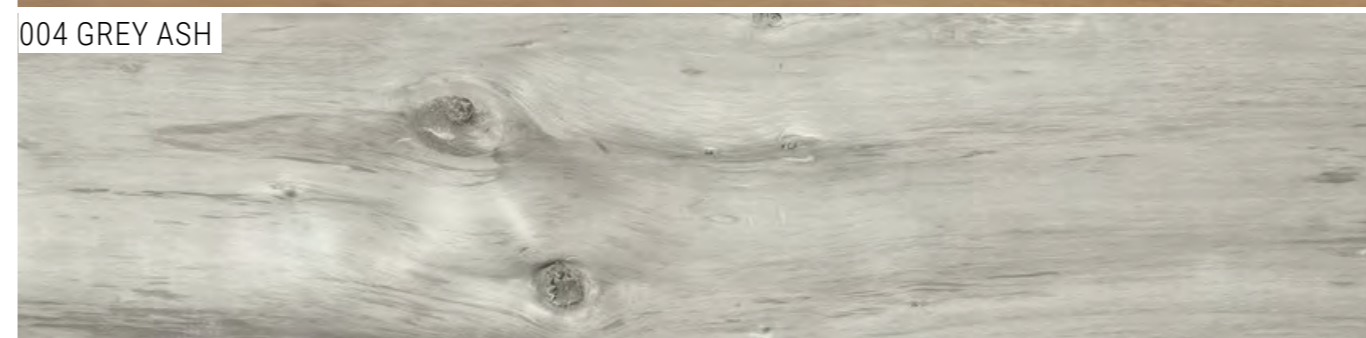

005 LARCH



006 ABETE OSSIDATO



MILLELEGNI

COLORI E FORMATI

Colours and Sizes | Couleurs et Formats | Farben und Formate | Colores y Tamaños | Цвета и Форматы

001 White Toulipier



002 Scottish Oak



003 Noce Selvatico

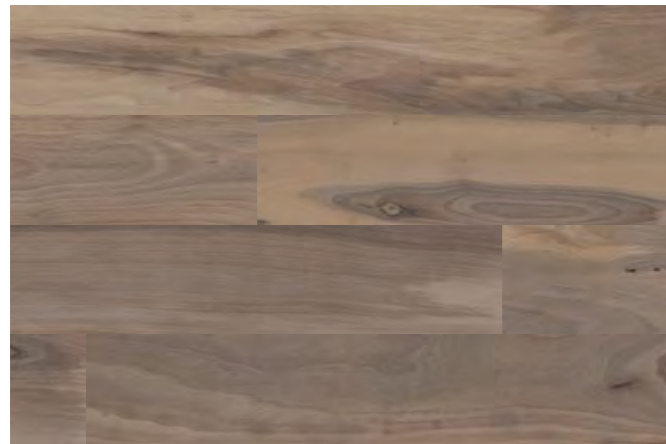

004 Grey Ash



005 Larch

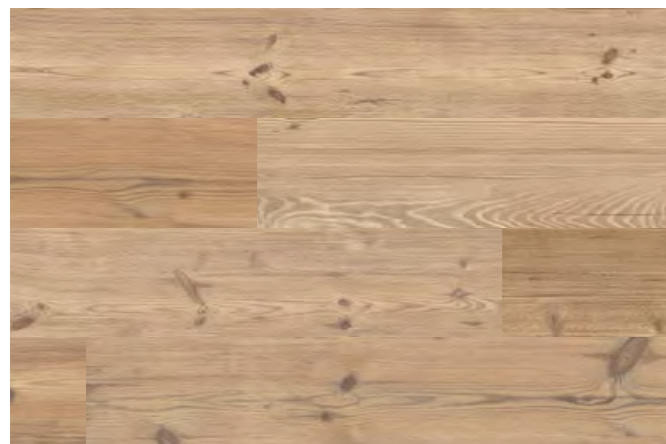

006 Abete Ossidato

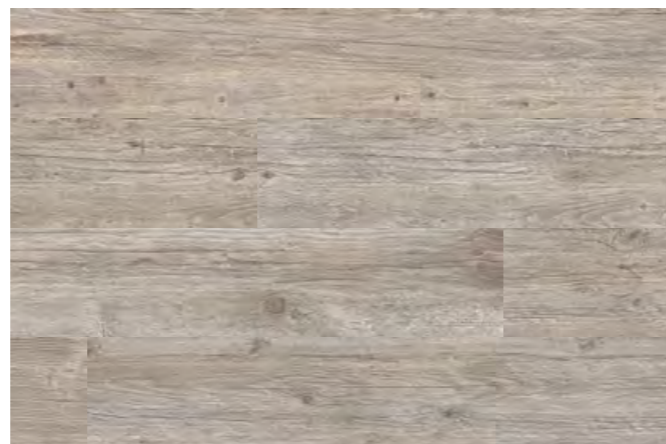

Si consiglia la posa con fuga 2 mm. - Laying with a 2 mm-joint is recommended. - Pose recommandée avec joints de 2 mm.
Es wird eine Fugenbreite von 2 mm empfohlen. - Se recomienda la colocación con juntas de 2 mm. - Рекомендуется укладка с швом 2 мм.

MILLELEGNI

COLORI E FORMATI

Colours and Sizes | Couleurs et Formats | Farben und Formate | Colores y Tamaños | Цвета и Форматы

9,5 mm.



Naturale Rett.

30x120 - 11^{13/16}"x47^{1/4}"

- E21Y 001 White Toulipier ● T23
- E21Z 002 Scottish Oak ● T23
- E24H 003 Noce Selvatico ● T23
- E220 004 Grey Ash ● T23
- E2NZ 005 Larch ● T23
- E2PO 006 Abete Ossidato ● T23



Naturale Rett.

20x120 - 7^{7/8}"x47^{1/4}"

- E21V 001 White Toulipier ● T23
- E21W 002 Scottish Oak ● T23
- E24G 003 Noce Selvatico ● T23
- E21X 004 Grey Ash ● T23
- E2NX 005 Larch ● T23
- E2NY 006 Abete Ossidato ● T23



Naturale Rett.

15x120 - 5^{7/8}"x47^{1/4}"

- E21R 001 White Toulipier ● T23
- E21S 002 Scottish Oak ● T23
- E24F 003 Noce Selvatico ● T23
- E21T 004 Grey Ash ● T23
- E2NU 005 Larch ● T23
- E2NV 006 Abete Ossidato ● T23

20MM



Naturale Rett.











40x120 - 15^{3/4}"x47^{1/4}"

- E37Q 002 Scottish Oak U₃₅P₃E₃C₂F₊ ● T67

Verificare l'abbinamento dei toni tra i formati differenti. - Check the colour matching between different sizes.
Vérifier l'assortiment des tonalités entre les différents formats. - Die Kombination der Farbtöne unter den verschiedenen Formaten prüfen.
Comprobar la combinación de los tonos entre los distintos formatos. - Проверьте сочетание тонов у разных форматов.



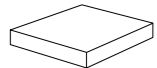

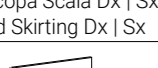
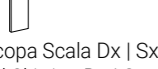

PEZZI SPECIALI

Trims | Pieces Speciales | Formteile | Piezas Especiales | Специальные Изделия

	Dimensione Size	 001 White Toulipier	 002 Scottish Oak	 003 Noce Selvatico	 004 Grey Ash	 005 Larch	 006 Abete Ossidato	Fascia di prezzo Price band
	Nat. Rett. 7x60 - 2 ^{3/4} "x23 ^{5/8} " Pcs. Box 15 - LM x Box 9,00	E297	E298	E299	E29A	E2VP	E2VQ	● A13
	Nat. Rett. 7x120 - 2 ^{3/4} "x47 ^{1/4} " Pcs. Box 6 - LM x Box 7,20	E291	E292	E293	E294	E2VL	E2VM	● A28
	Nat. Rett. 33x120x3,2x3,2 12 ^{15/16} "x47 ^{1/4} "x1 ^{1/4} "x1 ^{1/4} " Pcs. Box. 2 - LM x Box 2,40	E8FG	E8FH	E8FJ	E8FK	E91S	E91T	● A98
	Nat. Rett. 33x120x3,2x3,2 12 ^{15/16} "x47 ^{1/4} "x1 ^{1/4} "x1 ^{1/4} " Pcs. Box. 1 - LM x Box 1,20	DX E8EH	DX E8EK	DX E8EM	DX E8EP	DX E912	DX E914	● A104
		SX E8EJ	SX E8EL	SX E8EN	SX E8EQ	SX E913	SX E915	
	Nat. Rett. 33x33x3,2x3,2 12 ^{15/16} "x12 ^{15/16} "x1 ^{1/4} "x1 ^{1/4} " Pcs. Box 2 - LM x Box 0,66	DX E8FY	DX E8G0	DX E8G2	DX E8G4	DX E936	DX E938	● A72
		SX E8FZ	SX E8G1	SX E8G3	SX E8G5	SX E937	SX E939	
	Nat. Rett. 7x60x60 2 ^{3/4} "x23 ^{5/8} "x23 ^{5/8} " Pcs. Box 2 - LM x Box 1,20	-	DX E9FA	-	-	-	-	● A33
		-	SX E9FC	-	-	-	-	
	Nat. Rett. 7x60x60 2 ^{3/4} "x23 ^{5/8} "x23 ^{5/8} " Pcs. Box 2 - LM x Box 1,20	-	DX E9FD	-	-	-	-	● A33
		-	SX E9FE	-	-	-	-	

20MM PEZZI SPECIALI

Trims | Pieces Speciales | Formteile | Piezas Especiales | Специальные Изделия

	Dimensione Size	 002 Scottish Oak	Fascia di prezzo Price band
	Nat. Rett. 33x120x5 12 ^{15/16} "x47 ^{1/4} "x1 ^{15/16} " Pcs. Box 1 - LM x Box 1,20	E9FF	● A100
	Nat. Rett. 33x120x5 12 ^{15/16} "x47 ^{1/4} "x1 ^{15/16} " Pcs. Box 1 - LM x Box 1,20	DX E9FG	SX E9FH ● A105
	Nat. Rett. 33x120x2,5 12 ^{15/16} "x47 ^{1/4} "x1 ^{15/16} " Pcs. Box 1 - LM x Box 1,20	E9FK	● A100
	Nat. Rett. 33x120x2,5 12 ^{15/16} "x47 ^{1/4} "x1 ^{15/16} " Pcs. Box 1 - LM x Box 1,20	DX E9FL	SX E9FM ● A105
	Nat. Rett. 33x120 - 12 ^{15/16} "x47 ^{1/4} " Pcs. Box 1 - LM x Box 1,20	E9FN	● A96
	Nat. Rett. 16,5x120 - 6 ^{1/2} "x47 ^{1/4} " Pcs. Box 1 - LM x Box 1,20	E9FJ	● A56

IMBALLI E PESI

Packing and Weight | Emballages et Poids | Verpackung und Gewicht | Embalajes y Pesos | Упаковка и Вес

Formato Size Format Format Татапо Формат cm	Spessore Thickness Epaisseur Stärke Espesor Толщина mm	Pz. x Mq. Pieces x Sqm Pcs / M ² Stk. x Qm Pzs x Mc. Шт x Кв.М.	Pz. x Scat. Pieces x Box Pcs / Bte Stk. x Krt. Pzs x Caja Шт x Кор.	Mq. x Scat. Sqm x Box M ² / Bte Qm x Krt. Mc. x Caja Кв.М. x Кор.	Peso x Scat. Weight x Box Poids / Bte Gewicht x Krt. Peso x Caja Вес x Кор. Kg	Scat. x Pal. Boxes x Pal. Bte / Pal. Krt. x Pal. Cajas x Pal. Кор. x Подд.	Mq. x Pal. Sqm x Pal. M ² / Pal. Qm x Pal. Mc. x Pal. Кв.М x Подд.	Peso x Pal. Weight x Pal. Poids / Pal. Gewicht x Pal. Peso x Pal. Вес x Подд. Kg
30x120 Naturale	9,5	2,78	4	1,44	31,68	36	51,84	1140
20x120 Naturale	9,5	4,17	4	0,96	21,12	40	38,40	845
15x120 Naturale	9,5	5,56	6	1,08	23,76	42	45,36	998
40x120 Naturale 20MM	20	2,08	1	0,48	22,08	48	23,04	1060

MILLE remake LEGNI



FORMATI

Sizes | Formats | Formate | Tamaños | Форматы

9,5 mm.

25x150 - 9^{13/16}"x59^{1/6}" Naturale

20x120 - 7^{7/8}"x47^{1/4}" Naturale - Tecnica

20MM

40x120 - 15^{3/4}"x47^{1/4}" Naturale

SUPERFICI

Finishes | Finitions | Oberflächen
Superficies | Отделка поверхности

NATURALE

R10 DIN 51130

B (A+B) DIN 51097

Wet ≥ 0,50 DCOF

≥ 0,40 B.C.R.A.

P2 Pendolo AS 4586

< 36 Moderate Slip potential Pendolo BS 7976

- Pendolo UNE 41901

TECNICA | 20MM

R11 DIN 51130

C (A+B+C) DIN 51097

Wet ≥ 0,65 DCOF

≥ 0,40 B.C.R.A.

P4 Pendolo AS 4586

> 36 Low Slip potential Pendolo BS 7976

3 Pendolo UNE 41901

SHADE VARIATIONS



V3 HIGH

DESTINAZIONI D'USO

Intended uses | Domaines d'application
Zweckbestimmung | Usos previstos | Назначение



20% 20MM
12% 20x120
0% 25x150

TECNICA

Premium Technical Feature

Nella versione Tecnica la superficie è particolarmente antiscivolo, tanto da renderla perfetta per spazi esterni, pubblici e privati.
In the Tecnica version, the surface has outstanding anti-slip properties, making it perfect for public and private outdoor areas.



008 OLMO SBIANCATO



009 OLMO NATURALE



010 OLMO DORATO



011 OLMO TINTO

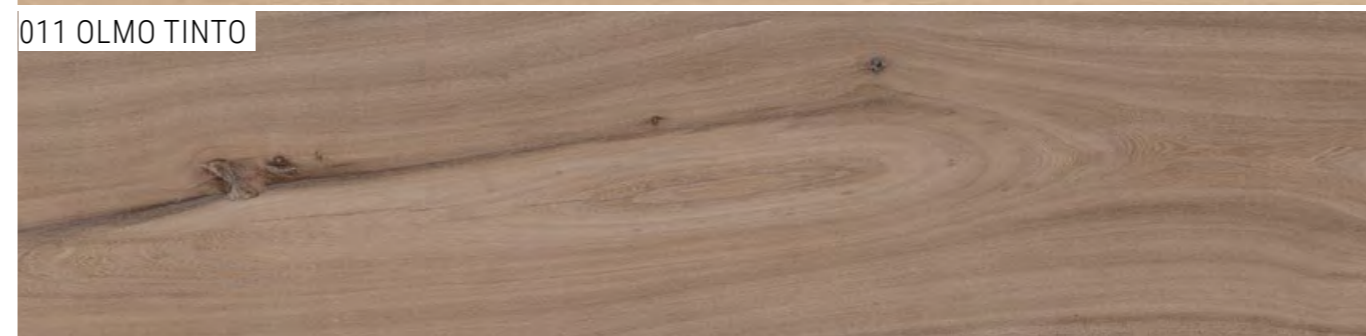

012 ROVERE OSSIDATO



013 ROVERE BRUNO OSSIDATO

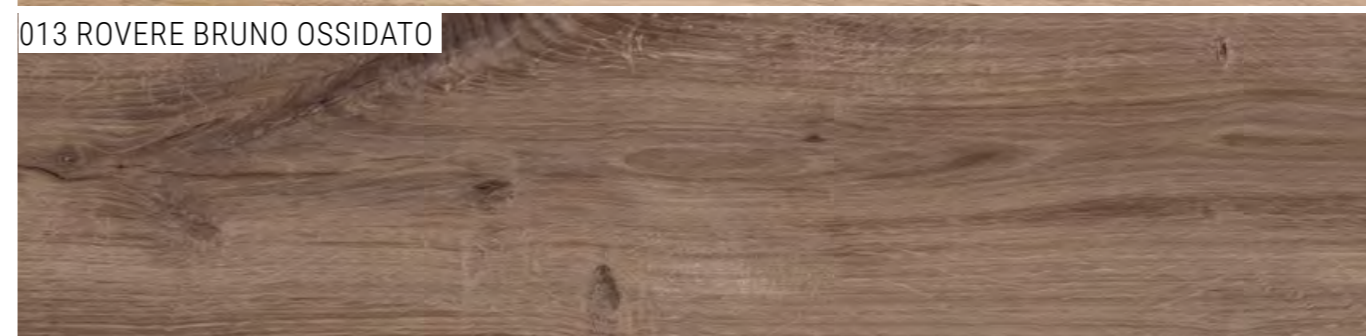

MILLELEGGNI REMAKE

COLORI E FORMATI

Colours and Sizes | Couleurs et Formats | Farben und Formate | Colores y Tamaños | Цвета и Форматы

008 Olmo Sbiancato



009 Olmo Naturale



010 Olmo Dorato

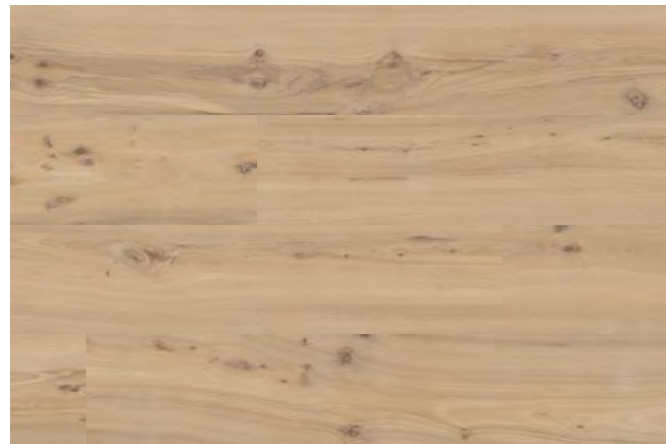

011 Olmo Tinto

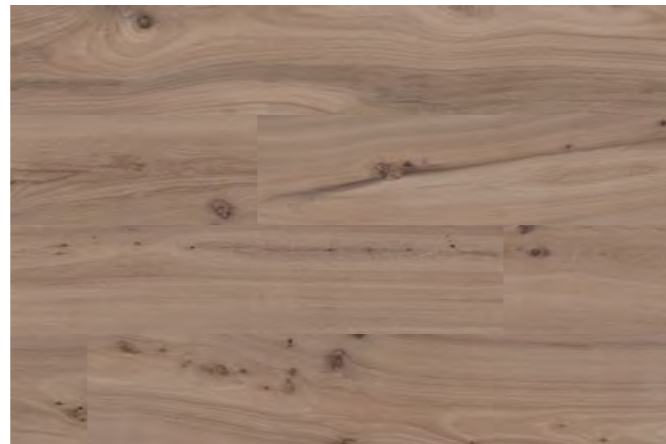

012 Rovere Ossidato

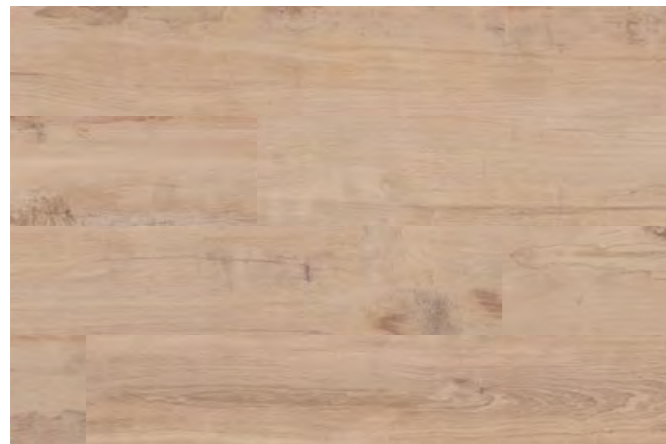

013 Rovere Bruno Ossidato

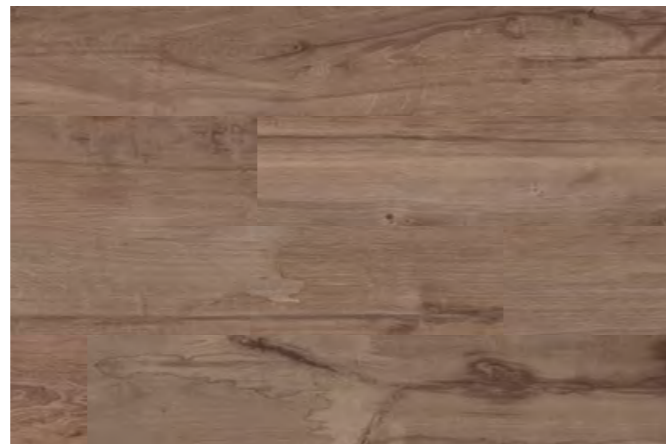

Si consiglia la posa con fuga 2 mm. - Laying with a 2 mm-joint is recommended. - Pose recommandée avec joints de 2 mm.
Es wird eine Fugenbreite von 2 mm empfohlen. - Se recomienda la colocación con juntas de 2 mm. - Рекомендуется укладка с швом 2 мм.

MILLELEGGNI REMAKE

COLORI E FORMATI

Colours and Sizes | Couleurs et Formats | Farben und Formate | Colores y Tamaños | Цвета и Форматы

9,5 mm.

Naturale Rett.

25x150 - 9^{13/16}"x59^{1/6}"

- EH2G 008 Olmo Sbiancato ● T38
- EH2H 009 Olmo Naturale ● T38
- EH5R 010 Olmo Dorato ● T38
- EH2J 011 Olmo Tinto ● T38
- EH2K 012 Rovere Ossidato ● T38
- EH2L 013 Rovere Bruno Ossidato ● T38

Naturale Rett.

20x120 - 7^{7/8}"x47^{1/4}"

- EH2N 008 Olmo Sbiancato ● T23
- EH2P 009 Olmo Naturale ● T23
- EH5T 010 Olmo Dorato ● T23
- EH2R 011 Olmo Tinto ● T23
- EH2S 012 Rovere Ossidato ● T23
- EH2T 013 Rovere Bruno Ossidato ● T23

Tecnica Rett.

20x120 - 7^{7/8}"x47^{1/4}"

- EHV3 009 Olmo Naturale ● T23
- EHV4 012 Rovere Ossidato ● T23

20MM

Naturale Rett.

40x120 - 15^{3/4}"x47^{1/4}"









- EH67 011 Olmo Tinto ● T67
- EH68 012 Rovere Ossidato ● T67

Verificare l'abbinamento dei toni tra i formati differenti. - Check the colour matching between different sizes.
Vérifier l'assortiment des tonalités entre les différents formats. - Die Kombination der Farbtöne unter den verschiedenen Formaten prüfen.
Comprobar la combinación de los tonos entre los distintos formatos. - Проверьте сочетание тонов у разных форматов.

MILLELEGGNI REMAKE

PEZZI SPECIALI

Trims | Pieces Speciales | Formteile | Piezas Especiales | Специальные Изделия

	Dimensione Size							Fascia di prezzo Price band
 Battiscopa - Skirting	Nat. Rett. 4,6x120 - 1 ¹³ / ₁₆ "x47 ¹ / ₄ " Pcs. Box 6 - LM x Box 7,20	EH2V	EH2W	EHKZ	EH2X	EH2Y	EH2Z	● A28
 Gradone - Step	Nat. Rett. 33x120x3,2x3,2 12 ¹⁵ / ₁₆ "x47 ¹ / ₄ "x1 ¹ / ₄ "x1 ¹ / ₄ " Pcs. Box. 2 - LM x Box 2,40	EH31	EH32	EHL1	EH33	EH34	EH35	● A98
 Angolare Dx Sx Corner Tile Dx Sx	Nat. Rett. 33x120x3,2x3,2 12 ¹⁵ / ₁₆ "x47 ¹ / ₄ "x1 ¹ / ₄ "x1 ¹ / ₄ " Pcs. Box. 1 - LM x Box 1,20	DX EH3L	DX EH3M	DX EHL7	DX EH3N	DX EH3P	DX EH3Q	● A104
		SX EH3S	SX EH3T	SX EHL9	SX EH3U	SX EH3V	SX EH3W	

Pezzi speciali 20mm su richiesta.
20mm trims available on request.
Pièces spéciales 20mm (sur demande).
Formteile 20mm auf anfrage erhältlich.
Piezas especiales 20mm disponibles bajo pedido.
Специальные изделия 20мм по запросу.

IMBALLI E PESI

Packing and Weight | Emballages et Poids | Verpackung und Gewicht | Embalajes y Pesos | Упаковка и Вес

Formato Size Format Format Татаño Формат cm	Spessore Thickness Epaisseur Stärke Espesor Толщина mm	Pz. x Mq. Pieces x Sqm Pcs / M ² Stk. x Qm Pzs x Mc. Шт x Кв.М.	Pz. x Scat. Pieces x Box Pcs / Bte Stk. x Krt. Pzs x Caja Шт x Кор.	Mq. x Scat. Sqm x Box M ² / Bte Qm x Krt. Mc. x Caja Кв.М. x Кор.	Peso x Scat. Weight x Box Poids / Bte Gewicht x Krt. Вес x Кор. Kg	Scat. x Pal. Boxes x Pal. Bte / Pal. Krt. x Pal. Cajas x Pal. Кор. x Подд.	Mq. x Pal. Sqm x Pal. M ² / Pal. Qm x Pal. Mc. x Pal. Кв.М x Подд.	Peso x Pal. Weight x Pal. Poids / Pal. Gewicht x Pal. Вес x Подд. Kg
25x150 Naturale	9,5	2,67	3	1,13	24,75	45	50,63	1114
20x120 Naturale - Tecnica	9,5	4,17	4	0,96	21,12	40	38,40	845
40x120 Naturale 20MM	20	2,08	1	0,48	22,08	48	23,04	1060

MILLELEGGNI REMAKE



Olmo Naturale Nat. Rett.
20x120 - 7⁷/₁₆"x47¹/₄"

Olmo Tinto Nat. Rett.
25x150 - 9¹³/₁₆"x59¹/₁₆"

NORDIKA



PRODUCT CERTIFIED FOR LOW CHEMICAL EMISSIONS:
ULCDM/CG
UL 2818

FORMATI

Sizes | Formats | Formate | Tamaños | Форматы

 9,5 mm.

60x120 - 23^{5/8}"x47^{1/4}" Naturale

90x90 - 35^{7/16}"x35^{7/16}" Naturale

45x90 - 17^{11/16}"x35^{7/16}" Naturale

60x60 - 23^{5/8}"x23^{5/8}" Naturale

30x60 - 11^{13/16}"x23^{5/8}" Naturale

20MM

50x100 - 19^{11/16}"x39^{3/8}" Naturale

SUPERFICI

Finishes | Finitions | Oberflächen
Superficies | Отделка поверхности

NATURALE

R10 DIN 51130

B (A+B) DIN 51097

Wet \geq 0,50 DCOF

\geq 0,40 B.C.R.A.

P3 Pendolo AS 4586

< 36 Moderate Slip potential Pendolo BS 7976

- Pendolo UNE 41901

20MM

R11 DIN 51130

C (A+B+C) DIN 51097

Wet \geq 0,65 DCOF

\geq 0,40 B.C.R.A.

P4 Pendolo AS 4586

> 36 Low Slip potential Pendolo BS 7976

3 Pendolo UNE 41901

SHADE VARIATIONS



V3 HIGH

DESTINAZIONI D'USO

Intended uses | Domaines d'application
Zweckbestimmung | Usos previstos | Назначение



12%
20% 20MM



SAND



GREY



DARK



NORDIKA

COLORI E FORMATI

Colours and Sizes | Couleurs et Formats | Farben und Formate | Colores y Tamaños | Цвета и Форматы

Sand



Grey



Dark



Si consiglia la posa con fuga 2 mm. - Laying with a 2 mm-joint is recommended. - Pose recommandée avec joints de 2 mm.
Es wird eine Fugenbreite von 2 mm empfohlen. - Se recomienda la colocación con juntas de 2 mm. - Рекомендуется укладка с швом 2 мм.

NORDIKA

COLORI E FORMATI

Colours and Sizes | Couleurs et Formats | Farben und Formate | Colores y Tamaños | Цвета и Форматы

 9,5 mm.



Naturale Rett.

60x120 - 23^{5/8}"x47^{1/4}"

ECUU Sand

● T31

ECUV Grey

● T31

ECUW Dark

● T31

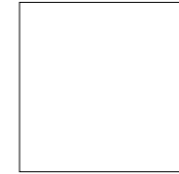

Naturale Rett.

90x90 - 35^{7/16}"x35^{7/16}"

ECUG Sand

● T34

ECUH Grey

● T34

ECUJ Dark

● T34



Naturale Rett.

45x90 - 17^{11/16}"x35^{7/16}"

ECUR Sand

● T23

ECUS Grey

● T23

ECUT Dark

● T23



Naturale Rett.

60x60 - 23^{5/8}"x23^{5/8}"

ECUK Sand

● T17

ECUL Grey

● T17

ECUM Dark

● T17



Naturale Rett.

30x60 - 11^{13/16}"x23^{5/8}"

ECUN Sand

● T14

ECUP Grey

● T14

ECUQ Dark

● T14

20MM



Naturale Rett.

50x100 - 19^{11/16}"x39^{3/8}"

ECWR Sand

● T67

ECWS Grey

● T67

ECWT Dark

● T67

Verificare l'abbinamento dei toni tra i formati differenti. - Check the colour matching between different sizes.
Vérifier l'assortiment des tonalités entre les différents formats. - Die Kombination der Farbtöne unter den verschiedenen Formaten prüfen.
Comprobar la combinación de los tonos entre los distintos formatos. - Проверьте сочетание тонов у разных форматов.

DECORI

Decors | Decors | Dekore | Decorados | Декоры

MOSAICO 3X3*

Tessera - Chip 2,8x2,8 - 1^{1/8}"x1^{1/8}"



30x30 - 11^{13/16}"x11^{13/16}"
ECWK Sand Nat. ● A96

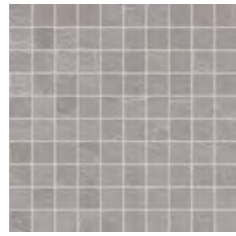

30x30 - 11^{13/16}"x11^{13/16}"
ECWL Grey Nat. ● A96

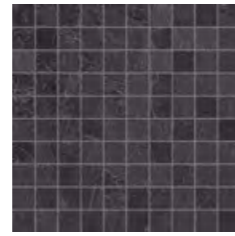

30x30 - 11^{13/16}"x11^{13/16}"
ECWM Dark Nat. ● A96

MOSAICO 10X10*

Tessera - Chip 9,8x9,8 - 3^{7/8}"x3^{7/8}"



30x30 - 11^{13/16}"x11^{13/16}"
ECWN Sand Nat. ● A78



30x30 - 11^{13/16}"x11^{13/16}"
ECWP Grey Nat. ● A78

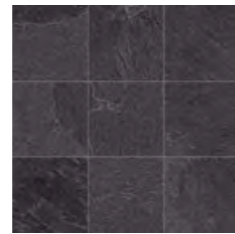

30x30 - 11^{13/16}"x11^{13/16}"
ECWQ Dark Nat. ● A78

* Su rete in fibra - On fibre mesh backing - Sur filet en fibre de verre - Auf Glasfasernetz - Sobre malla de fibra - На волоконной сетке

IMBALLI E PESI

Packing and Weight | Emballages et Poids | Verpackung und Gewicht | Embalajes y Pesos | Упаковка и Вес

Formato Size Format Format Tamaño Формат cm	Spessore Thickness Epaisseur Stärke Espesor Толщина mm	Pz. x Mq. Pieces x Sqm Pcs / M ² Stk. x Qm Pzs x Mc. Шт x Кв.М.	Pz. x Scat. Pieces x Box Pcs / Bte Stk. x Krt. Pzs x Caja Шт x Кор.	Mq. x Scat. Sqm x Box M ² / Bte Qm x Krt. Mc. x Caja Кв.М. x Кор.	Peso x Scat. Weight x Box Poids / Bte Gewicht x Krt. Peso x Caja Вес x Кор. Kg	Scat. x Pal. Boxes x Pal. Bte / Pal. Krt. x Pal. Cajas x Pal. Кор. x Подд.	Mq. x Pal. Sqm x Pal. M ² / Pal. Qm x Pal. Mc. x Pal. Кв.М x Подд.	Peso x Pal. Weight x Pal. Poids / Pal. Gewicht x Pal. Peso x Pal. Вес x Подд. Kg
60x120 Naturale	9,5	1,39	2	1,44	31,68	36	51,84	1140
90x90 Naturale	9,5	1,23	2	1,62	35,64	24	38,88	855
45x90 Naturale	9,5	2,47	3	1,22	26,73	32	38,88	855
60x60 Naturale	9,5	2,78	3	1,08	23,76	40	43,20	950
30x60 Naturale	9,5	5,56	6	1,08	23,76	48	51,84	1140
30x30 Mosaico 3X3 Naturale	9,5	11,11	5	0,45	8,73	60	27,00	524
30x30 Mosaico 10X10 Naturale	9,5	11,11	5	0,45	8,73	60	27,00	524
50x100 Naturale 20MM	20	2,00	1	0,50	23,00	50	25,00	1150

PEZZI SPECIALI

Trims | Pieces Speciales | Formteile | Piezas Especiales | Специальные Изделия

	Dimensione Size				Fascia di prezzo Price band			
Battiscopa - Skirting	Nat. Rett. 7x60 - 2 ^{3/4} "x23 ^{5/8} " Pcs. Box 15 - LM x Box 9,00	ECWU	ECWV	ECWW	● A11			
Gradino - Stair Tread	Nat. Rett. 4,6x90 - 1 ^{13/16} "x35 ^{7/16} " Pcs. Box 8 - LM x Box 7,20	ECWD	ECWE	ECWF	● A18			
Gradone - Step	Nat. Rett. 33x120 - 12 ^{15/16} "x47 ^{1/4} " Pcs. Box 2 - LM x Box 2,40	ED8U	ED8V	ED8W	● A82			
Angolare Dx Sx Corner Tile Dx Sx	Nat. Rett. 33x120x3,2x3,2 12 ^{15/16} "x47 ^{1/4} "x1 ^{1/4} "x1 ^{1/4} " Pcs. Box 2 - LM x Box 2,40	ECWG	ECWH	ECWJ	● A98			
Angolare Dx Sx Corner Tile Dx Sx	Nat. Rett. 33x120x3,2x3,2 12 ^{15/16} "x47 ^{1/4} "x1 ^{1/4} "x1 ^{1/4} " Pcs. Box 1 - LM x Box 1,20	DX ECW6	SX ECW7	DX ECW8	SX ECW9	DX ECWA	SX ECWC	● A104

20MM PEZZI SPECIALI

Trims | Pieces Speciales | Formteile | Piezas Especiales | Специальные Изделия

	Dimensione Size				Fascia di prezzo Price band			
Gradone - Step	Nat. Rett. 33x100x5 12 ^{15/16} "x39 ^{3/8} "x1 ^{15/16} " Pcs. Box 2 - LM x Box 2,00	ED18	ED1C	ED1F	● A91			
Angolare Dx Sx Corner Tile Dx Sx	Nat. Rett. 33x100x5 12 ^{15/16} "x39 ^{3/8} "x1 ^{15/16} " Pcs. Box 2 - LM x Box 2,00	DX ED19	SX ED1A	DX ED1D	SX ED1E	DX ED1G	SX ED1H	● A99
Terminale - Endingpiece	Nat. Rett. 33x100x2,5 12 ^{15/16} "x39 ^{3/8} "x1 ^{15/16} " Pcs. Box 2 - LM x Box 2,00	ED0Z	ED12	ED15	● A91			
Ang. Terminale Dx Sx Endingpiece Corner Dx Sx	Nat. Rett. 33x100x2,5 12 ^{15/16} "x39 ^{3/8} "x1 ^{15/16} " Pcs. Box 2 - LM x Box 2,00	DX ED10	SX ED11	DX ED13	SX ED14	DX ED16	SX ED17	● A99
Gradino - Stair Tread	Nat. Rett. 33x100 - 12 ^{15/16} "x39 ^{3/8} " Pcs. Box 2 - LM x Box 2,00	ED0W	ED0X	ED0Y	● A89			
Alzata - Riser	Nat. Rett. 16,5x100 - 6 ^{1/2} "x39 ^{3/8} " Pcs. Box 4 - LM x Box 4,00	ED0T	ED0U	ED0V	● A56			

On Square



FORMATI

Sizes | Formats | Formate | Tamaños | Форматы

9,5 mm.

60x120 - 23^{5/8}"x47^{1/4}" Naturale - Lappato

80x80 - 31^{1/2}"x31^{1/2}" Naturale - Lappato

45x90 - 17^{11/16}"x35^{7/16}" Naturale - Lappato

60x60 - 23^{5/8}"x23^{5/8}" Naturale - Lappato

30x60 - 11^{13/16}"x23^{5/8}" Naturale - Lappato

20MM

45x90 - 17^{11/16}"x35^{7/16}" Naturale

60x60 - 23^{5/8}"x23^{5/8}" Naturale

SUPERFICI

Finishes | Finitions | Oberflächen
Superficies | Отделка поверхности

NATURALE

R10 DIN 51130

B (A+B) DIN 51097

Wet \geq 0,50 DCOF

\geq 0,40 B.C.R.A.

P2 Pendolo AS 4586

< 36 Moderate Slip potential Pendolo BS 7976

2 Pendolo UNE 41901

LAPPATO

R9 DIN 51130

- DIN 51097

Wet \geq 0,42 DCOF

\geq 0,40 B.C.R.A.

- Pendolo AS 4586

- Pendolo BS 7976

- Pendolo UNE 41901

20MM

R11 DIN 51130

C (A+B+C) DIN 51097

Wet \geq 0,65 DCOF

\geq 0,40 B.C.R.A.

P4 Pendolo AS 4586

> 36 Low Slip potential Pendolo BS 7976

3 Pendolo UNE 41901

SHADE VARIATIONS



V3 HIGH

DESTINAZIONI D'USO

Intended uses | Domaines d'application
Zweckbestimmung | Usos previstos | Назначение

NATURALE - 20MM



LAPPATO



12%
6% 45x90 20MM
20% 60x60 20MM



AVORIO



SABBIA



CEMENTO



LAVAGNA

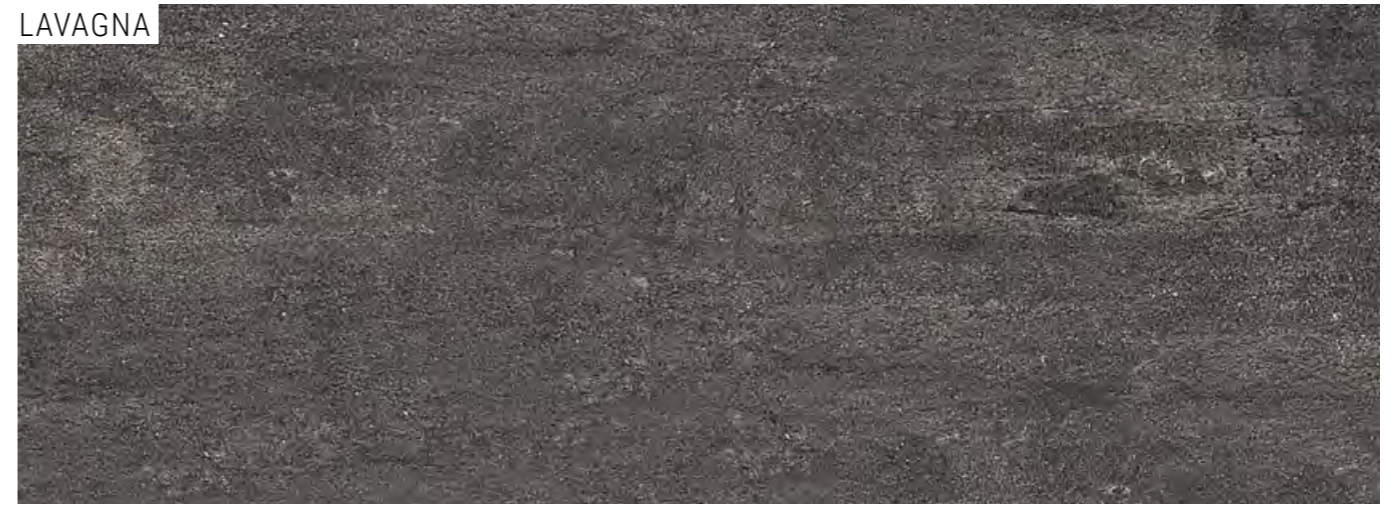

ON SQUARE

COLORI E FORMATI

Colours and Sizes | Couleurs et Formats | Farben und Formate | Colores y Tamaños | Цвета и Форматы

Avorio

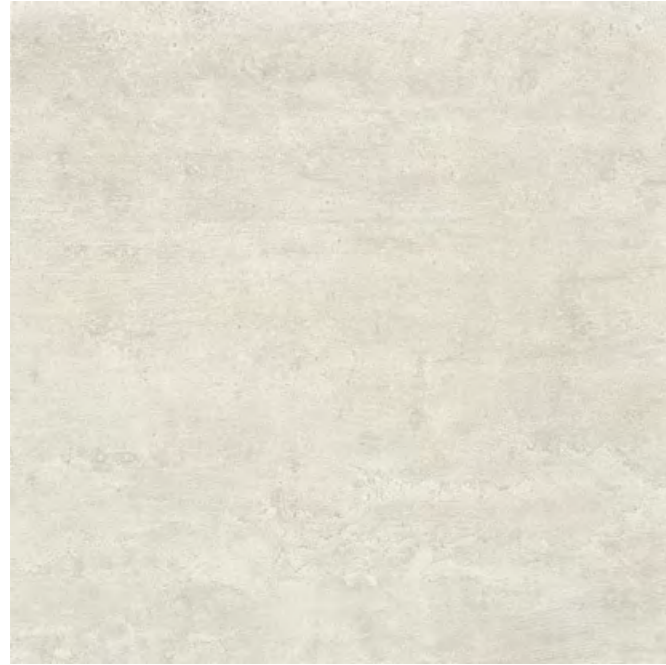

Sabbia



Cemento



Lavagna



Si consiglia la posa con fuga 2 mm. - Laying with a 2 mm-joint is recommended. - Pose recommandée avec joints de 2 mm.
Es wird eine Fugenbreite von 2 mm empfohlen. - Se recomienda la colocación con juntas de 2 mm. - Рекомендуется укладка с швом 2 мм.

ON SQUARE

COLORI E FORMATI

Colours and Sizes | Couleurs et Formats | Farben und Formate | Colores y Tamaños | Цвета и Форматы

 9,5 mm.



Naturale Rett.

60x120 - 23^{5/8}"x47^{1/4}"

- E78J Avorio ● T31
- E78K Sabbia ● T31
- E78L Cemento ● T31
- E78M Lavagna ● T31

Lappato Rett.

60x120 - 23^{5/8}"x47^{1/4}"

- E7HH Avorio ● T49
- E7HJ Sabbia ● T49
- E7GN Cemento ● T49
- E7HK Lavagna ● T49



Naturale Rett.

45x90 - 17^{11/16}"x35^{7/16}"

- E2LA Avorio ● T23
- E2LD Sabbia ● T23
- E2LF Cemento ● T23
- E2LH Lavagna ● T23

Lappato Rett.

45x90 - 17^{11/16}"x35^{7/16}"

- E2L9 Avorio ● T35
- E2LC Sabbia ● T35
- E2LE Cemento ● T35
- E2LG Lavagna ● T35



Naturale Rett.

80x80 - 31^{1/2}"x31^{1/2}"

- E1NS Avorio ● T25
- E1NU Sabbia ● T25
- E1NW Cemento ● T25
- E1NY Lavagna ● T25

Lappato Rett.

80x80 - 31^{1/2}"x31^{1/2}"

- E1NR Avorio ● T39
- E1NT Sabbia ● T39
- E1NV Cemento ● T39
- E1NX Lavagna ● T39



Naturale Rett.

60x60 - 23^{5/8}"x23^{5/8}"

- E1N9 Avorio ● T17
- E1NC Sabbia ● T17
- E1NE Cemento ● T17
- E1NG Lavagna ● T17

Lappato Rett.

60x60 - 23^{5/8}"x23^{5/8}"

- E1N8 Avorio ● T26
- E1NA Sabbia ● T26
- E1ND Cemento ● T26
- E1NF Lavagna ● T26



Naturale Rett.

30x60 - 11^{13/16}"x23^{5/8}"

- E1NJ Avorio ● T14
- E1NL Sabbia ● T14
- E1NN Cemento ● T14
- E1NQ Lavagna ● T14

Lappato Rett.

30x60 - 11^{13/16}"x23^{5/8}"

- E1NH Avorio ● T23
- E1NK Sabbia ● T23
- E1NM Cemento ● T23
- E1NP Lavagna ● T23

20MM



Naturale Rett.

45x90 - 17^{11/16}"x35^{7/16}"

- E7TW Cemento ● T45

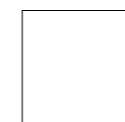

Naturale Rett.

60x60 - 23^{5/8}"x23^{5/8}"

- E2PE Avorio ● T34
- E2PF Sabbia ● T34
- E2PG Cemento ● T34
- E37L Lavagna ● T34

Verificare l'abbinamento dei toni tra i formati differenti. - Check the colour matching between different sizes.
Vérifier l'assortiment des tonalités entre les différents formats. - Die Kombination der Farbtöne unter den verschiedenen Formaten prüfen.
Comprobar la combinación de los tonos entre los distintos formatos. - Проверьте сочетание тонов у разных форматов.

ON SQUARE

DECORI

Decors | Decors | Dekore | Decorados | Декоры

ON SQUARE DECOR

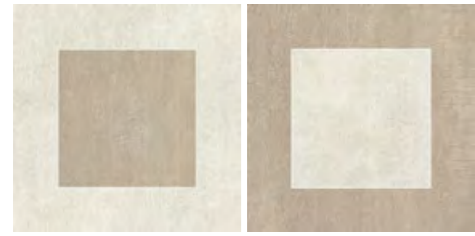

30x30 - 11^{13/16}"x11^{13/16}"
E1N6 Avorio/Sabbia Nat. Rett.
 Pcs. Box 4

● **A21**

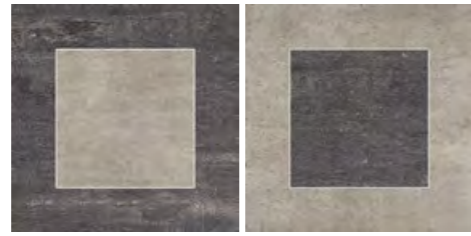

30x30 - 11^{13/16}"x11^{13/16}"
E1N7 Cemento/Lavagna Nat. Rett.
 Pcs. Box 4

● **A21**

MOSAICO*

Tessera - Chip 4,8x4,8 - 1^{7/8}"x1^{7/8}"



30x30 - 11^{13/16}"x11^{13/16}"
E2Y9 Avorio Nat. ● **A86**

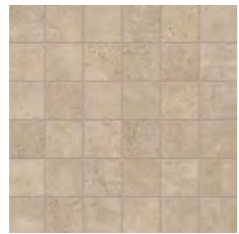

30x30 - 11^{13/16}"x11^{13/16}"
E2YA Sabbia Nat. ● **A86**

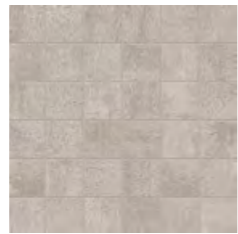

30x30 - 11^{13/16}"x11^{13/16}"
E2YC Cemento Nat. ● **A86**



30x30 - 11^{13/16}"x11^{13/16}"
E2YD Lavagna Nat. ● **A86**

LISTELLI SFALSATI*



30x60 - 11^{13/16}"x23^{5/8}"
E1N2 Avorio Nat. ● **A80**



30x60 - 11^{13/16}"x23^{5/8}"
E1N3 Sabbia Nat. ● **A80**



30x60 - 11^{13/16}"x23^{5/8}"
E1N4 Cemento Nat. ● **A80**

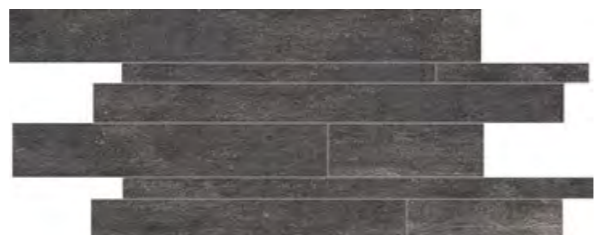

30x60 - 11^{13/16}"x23^{5/8}"
E1N5 Lavagna Nat. ● **A80**

* Su rete in fibra - On fibre mesh backing - Sur filet en fibre de verre - Auf Glasfasernetz - Sobre malla de fibra - На волоконной сетке

ON SQUARE

PEZZI SPECIALI

Trims | Pieces Speciales | Formteile | Piezas Especiales | Специальные Изделия

	Dimensione Size	Avorio	Sabbia	Cemento	Lavagna	Fascia di prezzo Price band				
Battiscopa - Skirting	Nat. Rett. 7x60 - 2 ^{3/4} "x23 ^{5/8} " Pcs. Box 15 - LM x Box 9,00	E1QM	E1QN	E1QP	E1QQ	● A11				
Gradone - Step	Nat. Rett. 33x60x3,2x3,2 12 ^{15/16} "x23 ^{5/8} "x1 ^{1/4} "x1 ^{1/4} " Pcs. Box 4 - LM x Box 2,40	E2DP	E8L7	E8L8	E2DQ	● A68				
	Nat. Rett. 33x120x3,2x3,2 12 ^{15/16} "x47 ^{1/4} "x1 ^{1/4} "x1 ^{1/4} " Pcs. Box 2 - LM x Box 2,40	E8T8	E8CZ	E8TC	E8TE	● A98				
	Lapp. Rett. 33x120x3,2x3,2 12 ^{15/16} "x47 ^{1/4} "x1 ^{1/4} "x1 ^{1/4} " Pcs. Box 2 - LM x Box 2,40	E8T7	E8T9	E8TA	E8TD	● A101				
Angolare Dx Sx Corner Tile Dx Sx	Nat. Rett. 33x120x3,2x3,2 12 ^{15/16} "x47 ^{1/4} "x1 ^{1/4} "x1 ^{1/4} " Pcs. Box 1 - LM x Box 1,20	DX E8SG	SX E8SH	DX E8SL	SX E8SM	DX E8SQ	SX E8SR	DX E8SU	SX E8SV	● A104
	Lapp. Rett. 33x120x3,2x3,2 12 ^{15/16} "x47 ^{1/4} "x1 ^{1/4} "x1 ^{1/4} " Pcs. Box 1 - LM x Box 1,20	DX E8SE	SX E8SF	DX E8SJ	SX E8SK	DX E8SN	SX E8SP	DX E8SS	SX E8ST	● A106
Angolare Corner Tile	Nat. Rett. 33x33x3,2x3,2 12 ^{15/16} "x12 ^{15/16} "x1 ^{1/4} "x1 ^{1/4} " Pcs. Box 2 - LM x Box 0,66	E8L6		E8LE		E8LF		E8LG		● A72
Battiscopa Scala Dx Sx Tread Skirting Dx Sx	Nat. Rett. 7x60x60 2 ^{3/4} "x23 ^{5/8} "x23 ^{5/8} " Pcs. Box 2 - LM x Box 1,20	DX E2W1	SX E954	DX E955	SX E956	DX E957	SX E958	DX E32X	SX E9F0	● A33
Battiscopa Scala Dx Sx Tread Skirting Dx Sx	Nat. Rett. 7x60x60 2 ^{3/4} "x23 ^{5/8} "x23 ^{5/8} " Pcs. Box 2 - LM x Box 1,20	DX E959	SX E95A	DX E95C	SX E95D	DX E95E	SX E95F	DX E9F1	SX E9F2	● A33

IMBALLI E PESI

Packing and Weight | Emballages et Poids | Verpackung und Gewicht | Embalajes y Pesos | Упаковка и Вес

Formato Size Format Format Tamaño Формат cm	Spessore Thickness Epaisseur Stärke Espesor Толщина mm	Pz. x Mq. Pcs / M ² Stk. x Qm Pzs x Mc. Шт x Кв.М.	Pz. x Scat. Pieces x Box Pcs / Bte Stk. x Krt. Pzs x Caja Шт x Кор.	Mq. x Scat. Sqm x Box M ² / Bte Qm x Krt. Mc. x Caja Кв.М. x Кор.	Peso x Scat. Weight x Box Poids / Bte Gewicht x Krt. Peso x Caja Вес x Кор. Kg	Scat. x Pal. Boxes x Pal. Bte / Pal. Krt. x Pal. Cajas x Подд. Кор. x Подд.	Mq. x Pal. Sqm x Pal. M ² / Pal. Qm x Pal. Mc. x Pal. Кв.М x Подд.	Peso x Pal. Weight x Pal. Poids / Pal. Gewicht x Pal. Peso x Pal. Вес x Подд. Kg
60x120 Naturale - Lappato	9,5	1,39	2	1,44	31,68	36	51,84	1140
45x90 Naturale - Lappato	9,5	2,47	3	1,22	26,73	32	38,88	855
80x80 Naturale - Lappato	9,5	1,56	2	1,28	28,16	42	53,76	1183
60x60 Naturale	9,5	2,78	3	1,08	23,76	40	43,20	950
30x60 Naturale	9,5	5,56	6	1,08	23,76	48	51,84	1140
30x60 Listelli Sfalsati Naturale	9,5	5,56	4	0,72	15,80	30	21,60	474
30x30 Mosaico Naturale	9,5	11,11	5	0,45	8,73	60	27,00	524
45x90 Naturale 20MM	20	2,47	2	0,81	37,26	24	19,44	894
60x60 Naturale 20MM	20	2,78	2	0,72	33,12	32	23,04	1060

20MM PEZZI SPECIALI

Trims | Pieces Speciales | Formteile | Piezas Especiales | Специальные Изделия

	Dimensione Size	Avorio		Sabbia		Cemento		Lavagna		Fascia di prezzo Price band
 Gradone - Step	Nat. Rett. 33x60x5 12 ^{15/16} "x23 ^{5/8} "x1 ^{15/16} " Pcs. Box 2 - LM x Box 1,20	E95R		E95U		E2W9		E9F3		● A68
	Nat. Rett. 33x90x5 12 ^{15/16} "x35 ^{7/16} "x1 ^{15/16} " Pcs. Box 2 - LM x Box 1,80	-		-		E9U7		-		● A80
 Angolare Dx Sx Corner Tile Dx Sx	Nat. Rett. 33x60x5 12 ^{15/16} "x23 ^{5/8} "x1 ^{15/16} " Pcs. Box 2 - LM x Box 1,20	DX E95S	SX E95T	DX E95V	SX E95W	DX E95X	SX E95Y	DX E9F4	SX E9F5	● A90
	Nat. Rett. 33x90x5 12 ^{15/16} "x35 ^{7/16} "x1 ^{15/16} " Pcs. Box 2 - LM x Box 1,80	-	-	-	-	DX E9U8	SX E9U9	-	-	● A96
 Terminale - Endingpiece	Nat. Rett. 33x60x2,5 12 ^{15/16} "x23 ^{5/8} "x1 ^{15/16} " Pcs. Box 2 - LM x Box 1,20	E968		E96C		E2WA		E9F6		● A72
	Nat. Rett. 33x90x2,5 12 ^{15/16} "x35 ^{7/16} "x1 ^{15/16} " Pcs. Box 2 - LM x Box 1,80	-		-		E9UY		-		● A84
 Ang. Terminale Dx Sx Endingpiece Corner Dx Sx	Nat. Rett. 33x60x2,5 12 ^{15/16} "x23 ^{5/8} "x1 ^{15/16} " Pcs. Box 2 - LM x Box 1,20	DX E969	SX E96A	DX E96D	SX E96E	DX E96F	SX E96G	DX E9F7	SX E9F8	● A90
	Nat. Rett. 33x90x2,5 12 ^{15/16} "x35 ^{7/16} "x1 ^{15/16} " Pcs. Box 2 - LM x Box 1,80	-	-	-	-	DX E9UZ	SX E9V0	-	-	● A96
 Gradino - Stair Tread	Nat. Rett. 33x60 - 12 ^{15/16} "x23 ^{5/8} " Pcs. Box 2 - LM x Box 1,20	E96H		E96J		E2WC		E9F9		● A66
	Nat. Rett. 33x90 - 12 ^{15/16} "x35 ^{7/16} " Pcs. Box 2 - LM x Box 1,80	-		-		E9VK		-		● A80
 Alzata - Riser	Nat. Rett. 16,5x60 - 6 ^{1/2} "x23 ^{5/8} " Pcs. Box 2 - LM x Box 1,20	E2W6		E2W7		E2W8		E37M		● A29
	Nat. Rett. 16,5x90 - 6 ^{1/2} "x35 ^{7/16} " Pcs. Box 4 - LM x Box 3,60	-		-		E9TV		-		● A49



Lavagna Naturale
60x60 - 23^{5/8}"x23^{5/8}"

Sabbia Naturale
30x60 - 11^{13/16}"x23^{5/8}"

On Square Decor Avorio/Sabbia
30x30 - 11^{13/16}"x11^{13/16}"

Petra



PRODUCT CERTIFIED FOR LOW CHEMICAL EMISSIONS:
ULCOM/CG
UL 2818

FORMATI

Sizes | Formats | Formate | Tamaños | Форматы

9,5 mm.

80x80 - 31^{1/2}"x31^{1/2}" Naturale - Lappato

20x80 - 7^{7/8}"x31^{1/2}" Naturale - Lappato

60x60 - 23^{5/8}"x23^{5/8}" Naturale - Lappato

30x60 - 11^{13/16}"x23^{5/8}" Naturale

SUPERFICI

Finishes | Finitions | Oberflächen
Superficies | Отделка поверхности

NATURALE

R10 DIN 51130

B (A+B) DIN 51097

Wet \geq 0,50 DCOF

\geq 0,40 B.C.R.A.

P2 Pendolo AS 4586

< 36 Moderate Slip potential Pendolo BS 7976

- Pendolo UNE 41901

LAPPATO

- DIN 51130

- DIN 51097

- DCOF

- B.C.R.A.

- Pendolo AS 4586

- Pendolo BS 7976

- Pendolo UNE 41901

SHADE VARIATIONS



V3 HIGH

DESTINAZIONI D'USO

Intended uses | Domaines d'application
Zweckbestimmung | Usos previstos | Назначение



放射能水平大類



12%



WHITE



BEIGE



GREY



PETRA

COLORI E FORMATI

Colours and Sizes | Couleurs et Formats | Farben und Formate | Colores y Tamaños | Цвета и Форматы

White



Beige



Grey



PETRA

COLORI E FORMATI

Colours and Sizes | Couleurs et Formats | Farben und Formate | Colores y Tamaños | Цвета и Форматы

9,5 mm.



Naturale Rett.
80x80 - 31^{1/2}x31^{1/2}"
E231 White ● T25
E233 Beige ● T25
E237 Grey ● T25

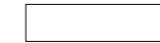

Naturale Rett.
20x80 - 7^{7/8}x31^{1/2}"
E239 White ● T64
E23C Beige ● T64
E23G Grey ● T64



Naturale Rett.
60x60 - 23^{5/8}x23^{5/8}"
E23N White ● T17
E23Q Beige ● T17
E23U Grey ● T17



Naturale Rett.
30x60 - 11^{13/16}x23^{5/8}"
E23V White ● T14
E23W Beige ● T14
E23Y Grey ● T14

Lappato Rett.
80x80 - 31^{1/2}x31^{1/2}"
E230 White ● T39
E232 Beige ● T39
E236 Grey ● T39

Lappato Rett.
20x80 - 7^{7/8}x31^{1/2}"
E238 White ● T82
E23A Beige ● T82
E23F Grey ● T82

Lappato Rett.
60x60 - 23^{5/8}x23^{5/8}"
E23M White ● T26
E23P Beige ● T26
E23T Grey ● T26

Si consiglia la posa con fuga 2 mm. - Laying with a 2 mm-joint is recommended. - Pose recommandée avec joints de 2 mm.
Es wird eine Fugenbreite von 2 mm empfohlen. - Se recomienda la colocación con juntas de 2 mm. - Рекомендуется укладка с швом 2 мм.

Verificare l'abbinamento dei toni tra i formati differenti. - Check the colour matching between different sizes.
Vérifier l'assortiment des tonalités entre les différents formats. - Die Kombination der Farbtöne unter den verschiedenen Formaten prüfen.
Comprobar la combinación de los tonos entre los distintos formatos. - Проверьте сочетание тонов у разных форматов.

DECORI

Decors | Decors | Dekore | Decorados | Декоры

DECORO QUADRI

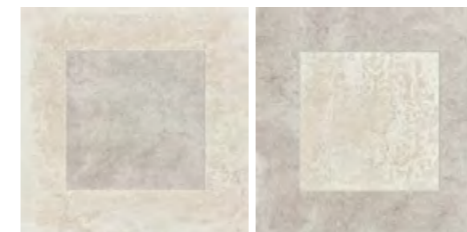

30x30 - 11^{13/16}x11^{13/16}"
E275 White/Grey Nat. Rett. ● A21
Pcs. Box 4

PETRA

DECORI

Decors | Decors | Dekore | Decorados | Декоры

MOSAICO 5X5*

Tessera - Chip 4,8x4,8 - 1^{7/8}"x1^{7/8}"



30x30 - 11^{13/16}"x11^{13/16}"
E25V White Nat. ● A86

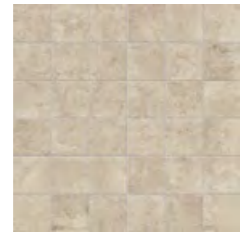

30x30 - 11^{13/16}"x11^{13/16}"
E25W Beige Nat. ● A86

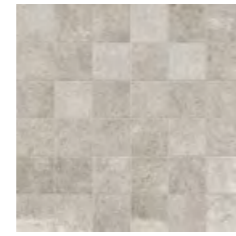

30x30 - 11^{13/16}"x11^{13/16}"
E25Y Grey Nat. ● A86

MURETTO PETRA*



30x30 - 11^{13/16}"x11^{13/16}"
E26P White Nat. ● A105



30x30 - 11^{13/16}"x11^{13/16}"
E26Q Beige Nat. ● A105



30x30 - 11^{13/16}"x11^{13/16}"
E26S Grey Nat. ● A105

LISTELLI SFALSATI*

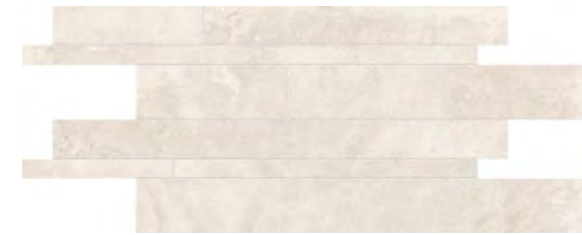

30x60 - 11^{13/16}"x23^{5/8}"
E26D White Nat. ● A80

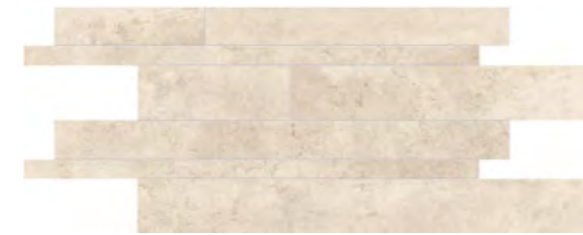

30x60 - 11^{13/16}"x23^{5/8}"
E26E Beige Nat. ● A80

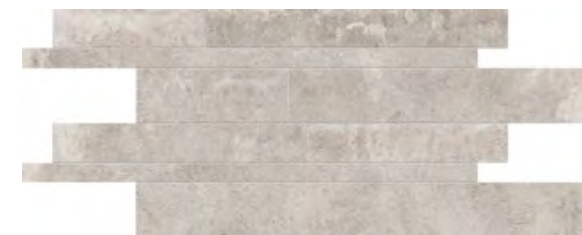

30x60 - 11^{13/16}"x23^{5/8}"
E26G Grey Nat. ● A80

* Su rete in fibra - On fibre mesh backing - Sur filet en fibre de verre - Auf Glasfasernetz - Sobre malla de fibra - На волоконной сетке

PETRA

PEZZI SPECIALI

Trims | Pieces Speciales | Formteile | Piezas Especiales | Специальные Изделия

	Dimensione Size	White	Beige	Grey	Fascia di prezzo Price band
 Battiscopa - Skirting	Nat. Rett. 7x60 - 2 ^{3/4} "x23 ^{5/8} " Pcs. Box 15 - LM x Box 9,00	E29D	E29F	E29K	● A11
	Lapp. Rett. 7x60 - 2 ^{3/4} "x23 ^{5/8} " Pcs. Box 15 - LM x Box 9,00	E29C	E29E	E29J	● A13
 Gradone - Step	Nat. Rett. 33x60x3,2x3,2 12 ^{15/16} "x23 ^{5/8} "x1 ^{1/4} "x1 ^{1/4} " Pcs. Box 4 - LM x Box 2,40	E28Z	E8FT	E8FX	● A68
	Lapp. Rett. 33x60x3,2x3,2 12 ^{15/16} "x23 ^{5/8} "x1 ^{1/4} "x1 ^{1/4} " Pcs. Box 4 - LM x Box 2,40	E8FR	E8FS	E8FW	● A70
 Angolare - Corner Tile	Nat. Rett. 33x33x3,2x3,2 12 ^{15/16} "x12 ^{15/16} "x1 ^{1/4} "x1 ^{1/4} " Pcs. Box 2 - LM x Box 0,66	E290	E8G8	E8GD	● A72
	Lapp. Rett. 33x33x3,2x3,2 12 ^{15/16} "x12 ^{15/16} "x1 ^{1/4} "x1 ^{1/4} " Pcs. Box 2 - LM x Box 0,66	E8G6	E8G7	E8GC	● A72

IMBALLI E PESI

Packing and Weight | Emballages et Poids | Verpackung und Gewicht | Embalajes y Pesos | Упаковка и Вес

Formato Size Format Format Татаño Формат cm	Spessore Thickness Epaisseur Stärke Espesor Толщина mm	Pz. x Mq. Pieces x Sqm Pcs / M ² Stk. x Qm Pzs x Mc. Шт x Кв.М.	Pz. x Scat. Pieces x Box Pcs / Bte Stk. x Krt. Pzs x Caja Шт x Кор.	Mq. x Scat. Sqm x Box M ² / Bte Qm x Krt. Кв.М. x Кор.	Peso x Scat. Weight x Box Poids / Bte Gewicht x Krt. Peso x Caja Вес x Кор. Kg	Scat. x Pal. Boxes x Pal. Bte / Pal. Krt. x Pal. Cajas x Pal. Кор. x Подд.	Mq. x Pal. Sqm x Pal. M ² / Pal. Qm x Pal. Mc. x Pal. Кв.М x Подд.	Peso x Pal. Weight x Pal. Poids / Pal. Gewicht x Pal. Peso x Pal. Вес x Подд. Kg
80x80 Naturale - Lappato	9,5	1,56	2	1,28	28,16	42	53,76	1183
20x80 Naturale - Lappato	9,5	6,25	6	0,96	22,00	42	40,32	924
60x60 Naturale - Lappato	9,5	2,78	3	1,08	23,76	40	43,20	950
30x60 Naturale	9,5	5,56	6	1,08	23,76	48	51,84	1140
30x60 Listelli Sfalsati Naturale	9,5	5,56	4	0,72	15,80	30	21,60	474
30x30 Mosaico 5X5 Naturale	9,5	11,11	5	0,45	8,73	60	27,00	524
30x30 Muretto Naturale	9,5	11,11	5	0,45	8,73	60	27,00	524

FORMATI

Sizes | Formats | Formate | Tamaños | Форматы

9,5 mm.

60x120 - 23^{5/8}"x47^{1/4}" Naturale

45x90 - 17^{11/16}"x35^{7/16}" Naturale

60x60 - 23^{5/8}"x23^{5/8}" Naturale

30x60 - 11^{13/16}"x23^{5/8}" Naturale

20MM

60x60 - 23^{5/8}"x23^{5/8}" Naturale

SUPERFICI

Finishes | Finitions | Oberflächen
Superficies | Отделка поверхности

NATURALE

R10 DIN 51130

B (A+B) DIN 51097

Wet \geq 0,50 DCOF

\geq 0,40 B.C.R.A.

P3 Pendolo AS 4586

> 36 Low Slip potential Pendolo BS 7976

2 Pendolo UNE 41901

OUTDOOR | 20MM

R11 DIN 51130

C (A+B+C) DIN 51097

Wet \geq 0,65 DCOF

\geq 0,40 B.C.R.A.

P4 Pendolo AS 4586

> 36 Low Slip potential Pendolo BS 7976

3 Pendolo UNE 41901

SHADE VARIATIONS



V3 HIGH

DESTINAZIONI D'USO

Intended uses | Domaines d'application
Zweckbestimmung | Usos previstos | Назначение



放射性水平低



12%
0% 20MM



SPAZZOLATA



FIAMMATA



COLORI E FORMATI

Colours and Sizes | Couleurs et Formats | Farben und Formate | Colores y Tamaños | Цвета и Форматы

Spazzolata



Fiammata

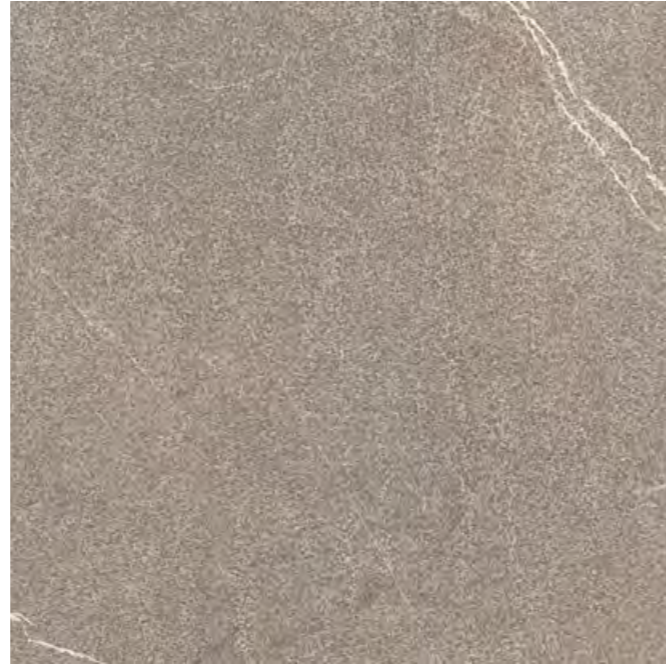

Si consiglia la posa con fuga 2 mm. - Laying with a 2 mm-joint is recommended. - Pose recommandée avec joints de 2 mm.
Es wird eine Fugenbreite von 2 mm empfohlen. - Se recomienda la colocación con juntas de 2 mm. - Рекомендуется укладка с швом 2 мм.

COLORI E FORMATI

Colours and Sizes | Couleurs et Formats | Farben und Formate | Colores y Tamaños | Цвета и Форматы

9,5 mm.

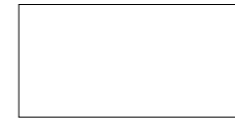

Naturale Rett.
60x120 - 23^{5/8}"x47^{1/4}"
E7VR Spazzolata
E7VT Fiammata

● **T31**
● **T31**

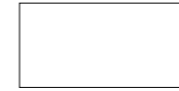

Naturale Rett.
45x90 - 17^{11/16}"x35^{7/16}"
E3ZP Spazzolata
E3ZR Fiammata

● **T23**
● **T23**



Naturale Rett.
60x60 - 23^{5/8}"x23^{5/8}"
E3Z8 Spazzolata
E3ZA Fiammata

● **T17**
● **T17**

Naturale Outdoor R11 Rett.

60x60 - 23^{5/8}"x23^{5/8}"
E485 Spazzolata ● **T17**
E3ZC Fiammata ● **T17**

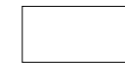

Naturale Rett.
30x60 - 11^{13/16}"x23^{5/8}"
E3ZG Spazzolata
E3ZJ Fiammata

● **T14**
● **T14**

Naturale Outdoor R11 Rett.

30x60 - 11^{13/16}"x23^{5/8}"
E487 Spazzolata ● **T14**
E3ZK Fiammata ● **T14**

20MM



Naturale Rett.
60x60 - 23^{5/8}"x23^{5/8}"
E3YW Fiammata

● **T34**

Verificare l'abbinamento dei toni tra i formati differenti. - Check the colour matching between different sizes.
Vérifier l'assortiment des tonalités entre les différents formats. - Die Kombination der Farbtöne unter den verschiedenen Formaten prüfen.
Comprobar la combinación de los tonos entre los distintos formatos. - Проверьте сочетание тонов у разных форматов.

DECORI

Decors | Decors | Dekore | Decorados | Декоры

MOSAICO ARELLA*



21x60 - 8^{1/4}"x23^{5/8}"
E46L Spazzolata Nat. ● A100



21x60 - 8^{1/4}"x23^{5/8}"
E46N Fiammata Nat. ● A100

MOSAICO 5X5*

Tessera - Chip 4,8x4,8 - 1^{7/8}"x1^{7/8}"



30x30 - 11^{13/16}"x11^{13/16}"
E458 Spazzolata Nat. ● A86

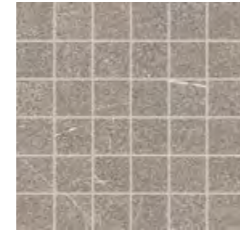

30x30 - 11^{13/16}"x11^{13/16}"
E45A Fiammata Nat. ● A86

LISTELLI SFALSATI*



30x60 - 11^{13/16}"x23^{5/8}"
E45F Spazzolata Nat. ● A80



30x60 - 11^{13/16}"x23^{5/8}"
E45H Fiammata Nat. ● A80

* Su rete in fibra - On fibre mesh backing - Sur filet en fibre de verre - Auf Glasfasernetz - Sobre malla de fibra - На волоконной сетке









IMBALLI E PESI

Packing and Weight | Emballages et Poids | Verpackung und Gewicht | Embalajes y Pesos | Упаковка и Вес

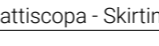
Formato Size Format Format Тamaño Формат cm	Spessore Thickness Epaisseur Stärke Espesor Толщина mm	Pz. x Mq. Pieces x Sqm Pcs / M ² Stk. x Qm Pzs x Mc. Шт x Кв.М.	Pz. x Scat. Pieces x Box Pcs / Bte Stk. x Krt. Pzs x Caja Шт x Кор.	Mq. x Scat. Sqm x Box M ² / Bte Qm x Krt. Mc. x Caja Кв.М. x Кор.	Peso x Scat. Weight x Box Poids / Bte Gewicht x Krt. Peso x Caja Вес x Кор. Kg	Scat. x Pal. Boxes x Pal. Bte / Pal. Krt. x Pal. Cajas x Pal. Кор. x Подд.	Mq. x Pal. Sqm x Pal. M ² / Pal. Qm x Pal. Mc. x Pal. Кв.М x Подд.	Peso x Pal. Weight x Pal. Poids / Pal. Gewicht x Pal. Peso x Pal. Вес x Подд. Kg
60x120 Naturale	9,5	1,39	2	1,44	31,68	36	51,84	1140
45x90 Naturale	9,5	2,47	3	1,22	26,73	32	38,88	855
60x60 Naturale	9,5	2,78	3	1,08	23,76	40	43,20	950
30x60 Naturale	9,5	5,56	6	1,08	23,76	48	51,84	1140
30x60 Listelli Sfalsati Naturale	9,5	5,56	4	0,72	15,80	30	21,60	474
21x60 Mosaico Arella Naturale	9,5	7,94	4	0,50	12,00	60	30,24	720
30x30 Mosaico 5X5 Naturale	9,5	11,11	5	0,45	8,73	60	27,00	524
60x60 Naturale 20MM	20	2,78	2	0,72	33,12	32	23,04	1060





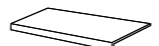

PEZZI SPECIALI

Trims | Pieces Speciales | Formteile | Piezas Especiales | Специальные Изделия

	Dimensione Size			Fascia di prezzo Price band		
	Nat. Rett. 7x60 - 2 ^{3/4} "x23 ^{5/8} " Pcs. Box 15 - LM x Box 9,00	E43Z	E441	● A11		
	Nat. Rett. 4,6x90 - 1 ^{13/16} "x35 ^{7/16} " Pcs. Box 8 - LM x Box 7,20	E46E	E46G	● A18		
	Indoor Nat. Rett. 33x60 - 12 ^{15/16} "x23 ^{5/8} " Pcs. Box 6 - LM x Box 3,60	EAQF	EAQH	● A54		
	Outdoor Nat. Rett. 33x60 - 12 ^{15/16} "x23 ^{5/8} " Pcs. Box 6 - LM x Box 3,60	EC9J	EAQJ	● A54		
	Nat. Rett. 33x60x3,2x3,2 12 ^{15/16} "x23 ^{5/8} "x1 ^{1/4} "x1 ^{1/4} " Pcs. Box 4 - LM x Box 2,40	EAPW	EAPY	● A68		
	Nat. Rett. 33x120x3,2x3,2 12 ^{15/16} "x47 ^{1/4} "x1 ^{1/4} "x1 ^{1/4} " Pcs. Box 2 - LM x Box 2,40	ECCN	ECCQ	● A98		
	Nat. Rett. 33x60x3,2x3,2 12 ^{15/16} "x23 ^{5/8} "x1 ^{1/4} "x1 ^{1/4} " Pcs. Box 2 - LM x Box 1,20	DX EAQ3	SX EAQ4	DX EAQ7	SX EAQ8	● A90
	Nat. Rett. 33x120x3,2x3,2 12 ^{15/16} "x47 ^{1/4} "x1 ^{1/4} "x1 ^{1/4} " Pcs. Box 1 - LM x Box 1,20	DX ECCA	SX ECCC	DX ECCF	SX ECCG	● A104
	Outdoor Nat. Rett. 15x60x5 5 ^{7/8} "x23 ^{5/8} "x1 ^{15/16} " Pcs. Box 4 - LM x Box 2,40	EC9K	EAQN	● A34		

20MM PEZZI SPECIALI

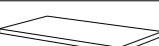
Trims | Pieces Speciales | Formteile | Piezas Especiales | Специальные Изделия

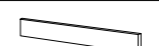
	Dimensione Size		Fascia di prezzo Price band	
	Nat. Rett. 33x60x5 12 ^{15/16} "x23 ^{5/8} "x1 ^{15/16} " Pcs. Box 2 - LM x Box 1,20	EARA	● A68	
	Nat. Rett. 33x60x5 12 ^{15/16} "x23 ^{5/8} "x1 ^{15/16} " Pcs. Box 2 - LM x Box 1,20	DX EARC	SX EARD	● A90
	Nat. Rett. 33x60x2,5 12 ^{15/16} "x23 ^{5/8} "x1 ^{15/16} " Pcs. Box 2 - LM x Box 1,20	EARE	● A72	
	Nat. Rett. 33x60x2,5 12 ^{15/16} "x23 ^{5/8} "x1 ^{15/16} " Pcs. Box 2 - LM x Box 1,20	DX EARF	SX EARG	● A90
	Nat. Rett. 33x60 - 12 ^{15/16} "x23 ^{5/8} " Pcs. Box 2 - LM x Box 1,20	EARJ	● A66	
	Nat. Rett. 16,5x60 - 6 ^{1/2} "x23 ^{5/8} " Pcs. Box 2 - LM x Box 1,20	EAR4	● A29	

SLEEKWOOD



PRODUCT CERTIFIED
FOR LOW CHEMICAL
EMISSIONS:
ULCDM/CG
UL 2818

FORMATI

Sizes | Formats | Formate | Tamaños | Форматы

8,5 mm.

15x90 - 7⁷/₈"x35⁷/₁₆" Naturale

9 mm.

Chevron 11x54 - 4⁵/₁₆"x21¹/₄" Naturale

SUPERFICI

Finishes | Finitions | Oberflächen
Superficies | Отделка поверхности

NATURALE

R9 DIN 51130

A DIN 51097

Wet \geq 0,42 DCOF

\geq 0,40 B.C.R.A.

- Pendolo AS 4586

- Pendolo BS 7976

- Pendolo UNE 41901

SHADE VARIATIONS



V3 HIGH

DESTINAZIONI D'USO

Intended uses | Domaines d'application
Zweckbestimmung | Usos previstos | Назначение



23% 15x90
16% Chevron 11x54



WHITE



BEIGE

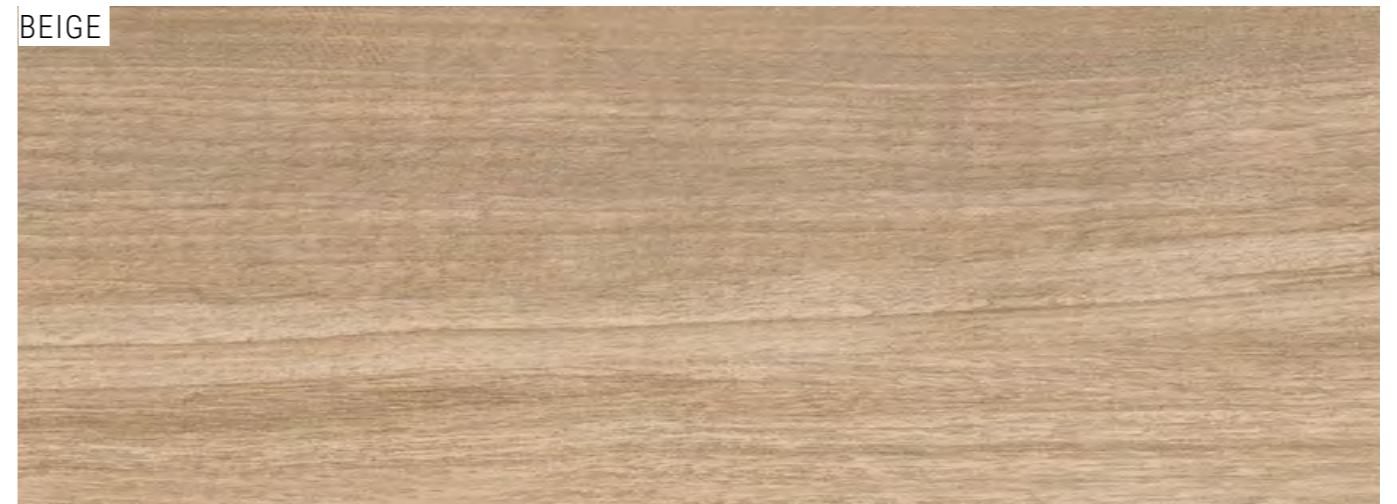

MOHOGANY



NUT



SLEEKWOOD

COLORI E FORMATI

Colours and Sizes | Couleurs et Formats | Farben und Formate | Colores y Tamaños | Цвета и Форматы

White



Beige



Mohogany

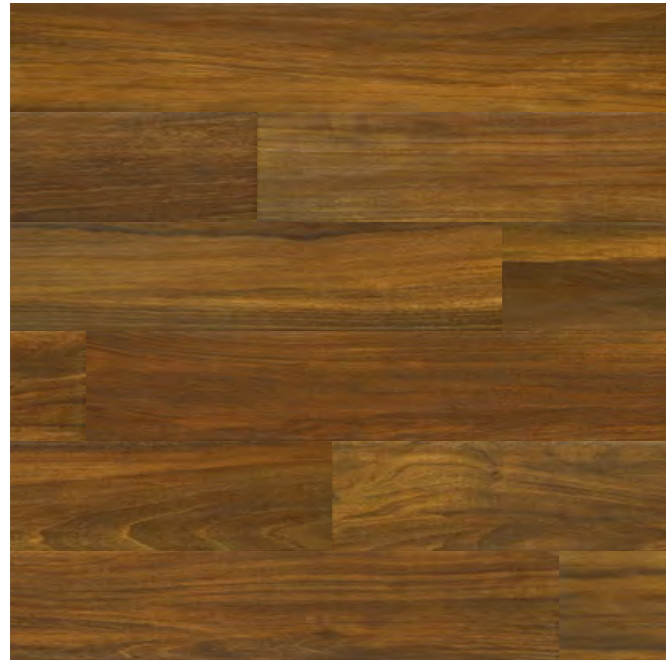

Nut



SLEEKWOOD

COLORI E FORMATI

Colours and Sizes | Couleurs et Formats | Farben und Formate | Colores y Tamaños | Цвета и Форматы

 **8,5 mm.**

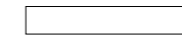

Naturale
15x90 - 5⁷/₈"x35⁷/₁₆"
EFC2 White ● T6
EFC4 Beige ● T6
EFC3 Mohogany ● T6
EFC5 Nut ● T6

 **9 mm.**

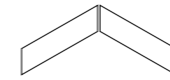

Naturale
Chevron 11x54 - 4⁵/₁₆"x21¹/₄"
EFCY White ● T12
EFC0 Beige ● T12
EFCZ Mohogany ● T12
EFC1 Nut ● T12

PEZZI SPECIALI

Trims | Pieces Speciales | Formteile | Piezas Especiales | Специальные Изделия

	Dimensione Size					Fascia di prezzo Price band
 Battiscopa - Skirting	Naturale 7x90 - 2 ³ / ₄ "x35 ⁷ / ₁₆ " Pcs. Box. 9 - LM x Box 8,10	White	Beige	Mohogany	Nut	● A12
		EF1R	EF1S	EF1T	EF1U	

IMBALLI E PESI

Packing and Weight | Emballages et Poids | Verpackung und Gewicht | Embalajes y Pesos | Упаковка и Вес

Formato Size Format Format Tamaño Формат cm	Spessore Thickness Epaisseur Stärke Espesor Толщина mm	Pz. x Mq. Pieces x Sqm Pcs / M ² Stk. x Qm Pzs x Mc. Шт x Кв.М.	Pz. x Scat. Pieces x Box Pcs / Bte Stk. x Krt. Pzs x Caja Шт x Кор.	Mq. x Scat. Sqm x Box M ² / Bte Qm x Krt. Mc. x Caja Кв.М. x Кор.	Peso x Scat. Weight x Box Poids / Bte Gewicht x Krt. Peso x Caja Вес x Кор. Kg	Scat. x Pal. Boxes x Pal. Bte / Pal. Krt. x Pal. Cajas x Pal. Кор. x Подд.	Mq. x Pal. Sqm x Pal. M ² / Pal. Qm x Pal. Mc. x Pal. Кв.М x Подд.	Peso x Pal. Weight x Pal. Poids / Pal. Gewicht x Pal. Peso x Pal. Вес x Подд. Kg
15x90 Naturale	8,5	7,41	8	1,08	20,73	48	51,84	995
11x54 Chevron Naturale	9	-	18	0,94	18,33	45	42,44	825

STONEBOX



PRODUCT CERTIFIED FOR LOW CHEMICAL EMISSIONS: ULCDM/CG UL 2818

FORMATI

Sizes | Formats | Formate | Tamaños | Форматы

9,5 mm.

45x90 - 17^{11/16}"x35^{7/16}" Naturale - Lappato

15x90 - 5^{7/8}"x35^{7/16}" Naturale

SUPERFICI

Finishes | Finitions | Oberflächen
Superficies | Отделка поверхности

NATURALE

R10 DIN 51130

B (A+B) DIN 51097

Wet \geq 0,50 DCOF

\geq 0,40 B.C.R.A.

- Pendolo AS 4586

- Pendolo BS 7976

2 Pendolo UNE 41901

LAPPATO

R9 DIN 51130

- DIN 51097

Wet \geq 0,42 DCOF

\geq 0,40 B.C.R.A.

- Pendolo AS 4586

- Pendolo BS 7976

- Pendolo UNE 41901

SHADE VARIATIONS



V3 HIGH

DESTINAZIONI D'USO

Intended uses | Domaines d'application
Zweckbestimmung | Usos previstos | Назначение



放射能水平低



12%



SUGAR WHITE



BRIGHT GREY

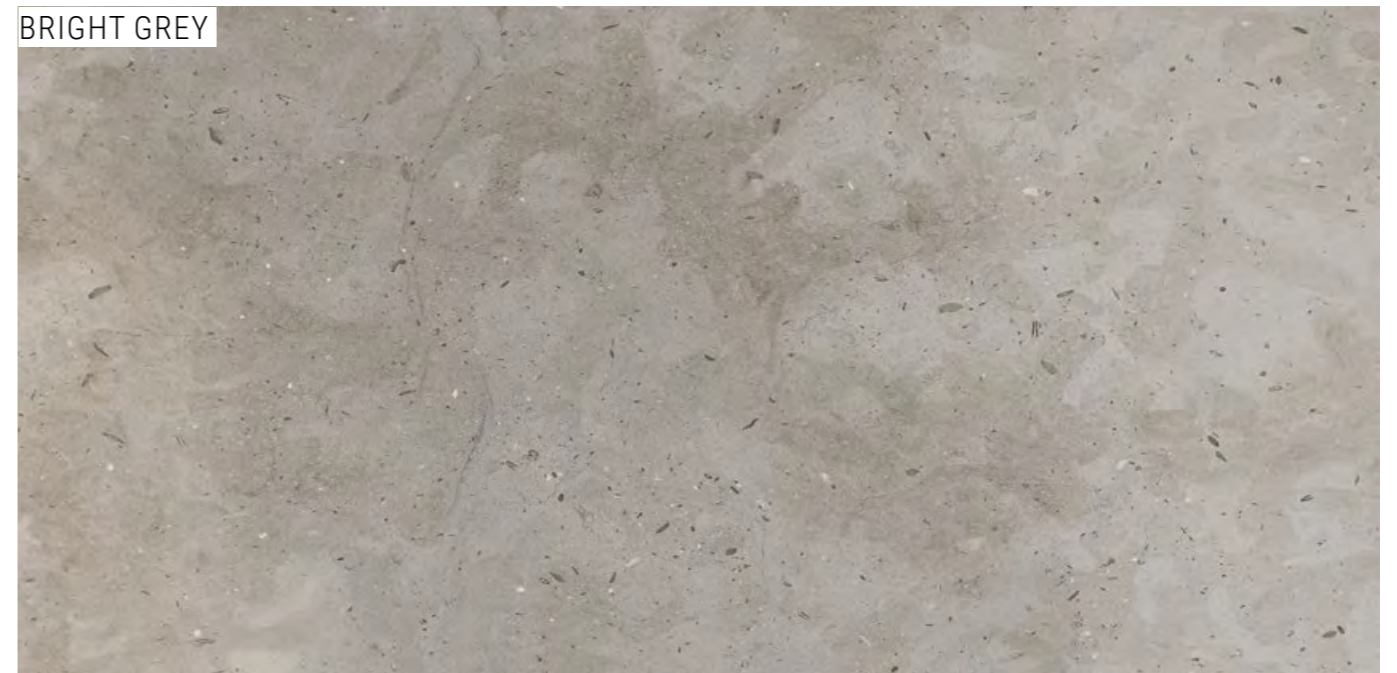

BLACK INK



STONE BOX

COLORI E FORMATI

Colours and Sizes | Couleurs et Formats | Farben und Formate | Colores y Tamaños | Цвета и Форматы

Sugar White



Bright Grey



Black Ink



STONE BOX

COLORI E FORMATI

Colours and Sizes | Couleurs et Formats | Farben und Formate | Colores y Tamaños | Цвета и Форматы

9,5 mm.



Naturale Rett.
45x90 - 17^{11/16}"x35^{7/16}"
E1UN Sugar White ● T23
E1US Bright Grey ● T23
E1UU Black Ink ● T23

Lappato Rett.
45x90 - 17^{11/16}"x35^{7/16}"
E1UM Sugar White ● T35
E1UR Bright Grey ● T35
E1UT Black Ink ● T35



Naturale Rett.
15x90 - 5^{7/8}"x35^{7/16}"
E1UH Sugar White ● T19
E1UK Bright Grey ● T19
E1UL Black Ink ● T19

Consigli di posa: per ottenere un risultato estetico ottimale, miscelare il materiale di scatole differenti. - Laying suggestions: to obtain excellent aesthetic results, it is recommended to mix the materials contained in different boxes. - Conseils de pose: pour obtenir d'excellents résultats du point de vue esthétique, mélangez les matériaux contenus dans des boîtes différentes. - Empfehlung für die Verlegung: um ein optimales ästhetisches Ergebnis zu erzielen, das Material der verschiedenen Schachteln mischen. - Consejos para la colocación: para obtener un resultado estético óptimo, mezclar el material de cajas diferentes. - Советы по укладке: Для достижения оптимального эстетического результата, рекомендуется смешивать материал из разных коробок.

Si consiglia la posa con fuga 2 mm. - Laying with a 2 mm-joint is recommended. - Pose recommandée avec joints de 2 mm. Es wird eine Fugenbreite von 2 mm empfohlen. - Se recomienda la colocación con juntas de 2 mm. - Рекомендуется укладка с швом 2 мм.

Verificare l'abbinamento dei toni tra i formati differenti. - Check the colour matching between different sizes. Vérifier l'assortiment des tonalités entre les différents formats. - Die Kombination der Farbtöne unter den verschiedenen Formaten prüfen. Comprobar la combinación de los tonos entre los distintos formatos. - Проверьте сочетание тонов у разных форматов.

IMBALLI E PESI

Packing and Weight | Emballages et Poids | Verpackung und Gewicht | Embalajes y Pesos | Упаковка и Вес

Formato Size Format Formato Тamaño Формат cm	Spessore Thickness Épaisseur Stärke Espesor Толщина mm	Pz. x Mq. Pieces x Sqm Pcs / M ² Stk. x Qm Pzs x Mc. Шт x Кв.М.	Pz. x Scat. Pieces x Box Pcs / Bte Stk. x Krt. Pzs x Caja Шт x Кор.	Mq. x Scat. Sqm x Box M ² / Bte Qm x Krt. Mc. x Caja Кв.М. x Кор.	Peso x Scat. Weight x Box Poids / Bte Gewicht x Krt. Peso x Caja Вес x Кор. Kg	Scat. x Pal. Boxes x Pal. Bte / Pal. Krt. x Pal. Cajas x Pal. Кор. x Подд.	Mq. x Pal. Sqm x Pal. M ² / Pal. Qm x Pal. Mc. x Pal. Кв.М x Подд.	Peso x Pal. Weight x Pal. Poids / Pal. Gewicht x Pal. Peso x Pal. Вес x Подд. Kg
45x90 Naturale - Lappato	9,5	2,47	3	1,22	26,73	32	38,88	855
15x90 Naturale	9,5	7,41	7	0,95	20,79	45	42,53	936

FORMATI

Sizes | Formats | Formate | Tamaños | Форматы

6,5 mm.

120x278 - 47^{1/4}"x109^{7/16}" Full Lappato

120x240 - 47^{1/4}"x94^{1/2}" Full Lappato

120x120 - 47^{1/4}"x47^{1/4}" Full Lappato

10,5 mm.

90x180 - 35^{7/16}"x70^{7/8}" Full Lappato

9,5 mm.

90x90 - 35^{7/16}"x35^{7/16}" Full Lappato

60x120 - 23^{5/8}"x47^{1/4}" Naturale - Full Lappato

30x60 - 11^{13/16}"x23^{5/8}" Naturale - Full Lappato

7,5x30 - 2^{15/16}"x11^{13/16}" Naturale

SUPERFICI

Finishes | Finitions | Oberflächen
Superficies | Отделка поверхности

NATURALE

R9 DIN 51130

- DIN 51097

Wet \geq 0,42 DCOF

\geq 0,40 B.C.R.A.

- Pendolo AS 4586

- Pendolo BS 7976

- Pendolo UNE 41901

FULL LAPPATO

- DIN 51130

- DIN 51097

- DCOF

- B.C.R.A.

- Pendolo AS 4586

- Pendolo BS 7976

- Pendolo UNE 41901

SHADE VARIATIONS



DESTINAZIONI D'USO

Intended uses | Domaines d'application
Zweckbestimmung | Usos previstos | Назначение



12% Statuario Michelangelo
0% Slabs 6,5 mm.



STATUARIO MICHELANGELO

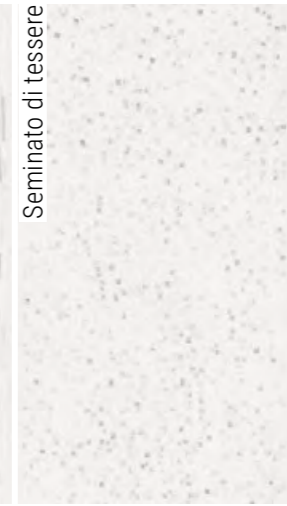
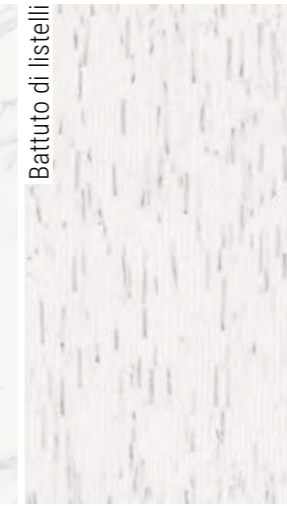
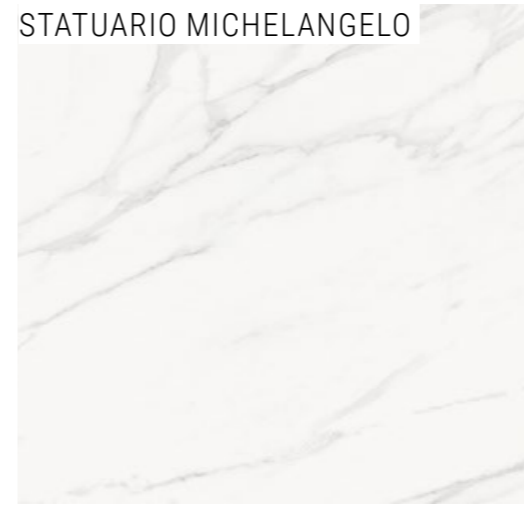

BRECCIA BRAQUE



FRAPPUCCINO POLLOCK

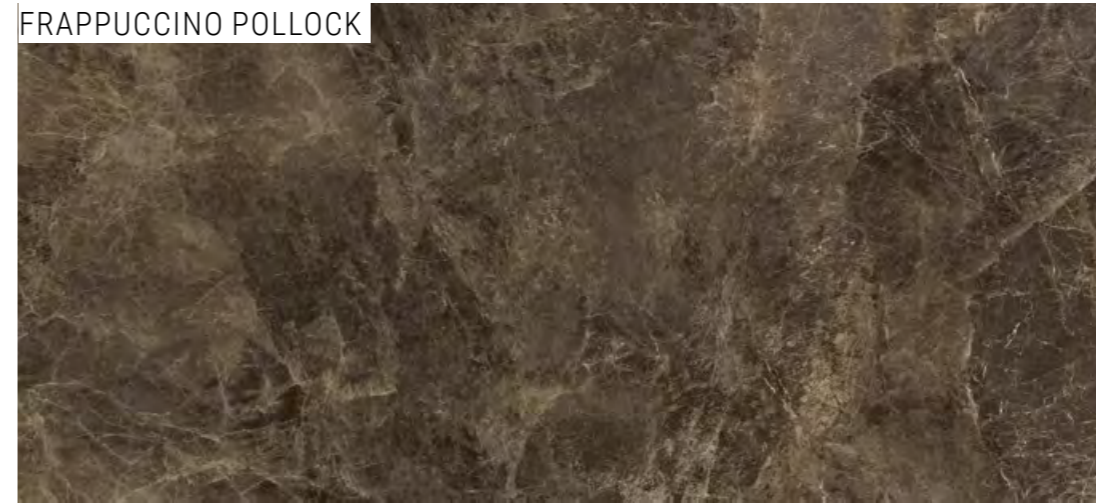

CALACATTA RENOIR

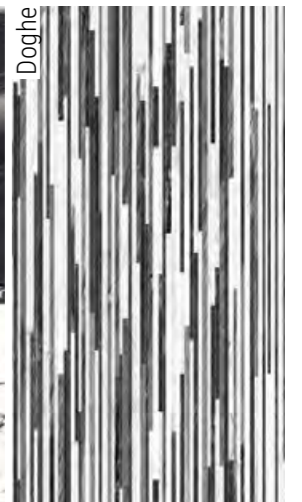
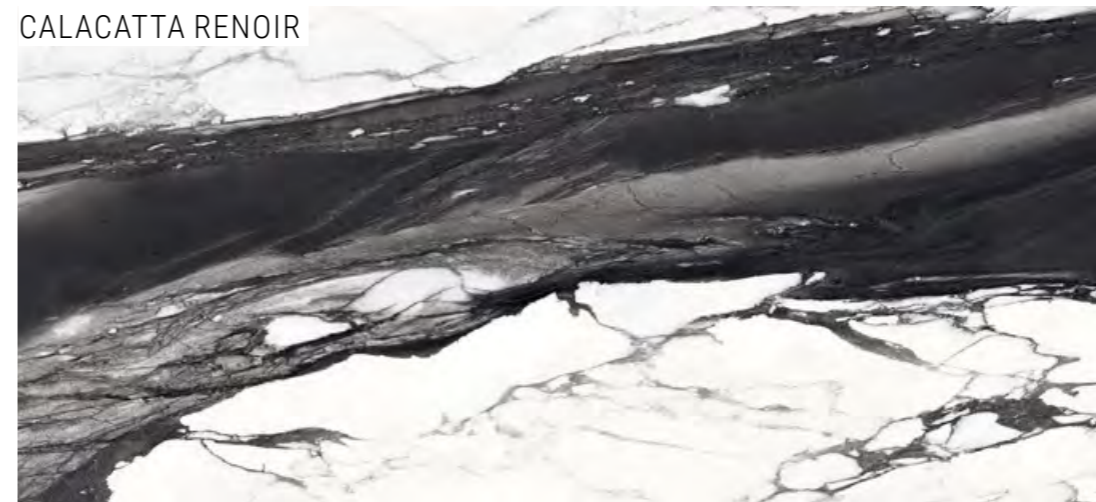

TELE DI MARMO

COLORI E FORMATI

Colours and Sizes | Couleurs et Formats | Farben und Formate | Colores y Tamaños | Цвета и Форматы

Statuario Michelangelo



Doghe



Si consiglia la posa con fuga 2 mm. - Laying with a 2 mm-joint is recommended. - Pose recommandée avec joints de 2 mm.
Es wird eine Fugenbreite von 2 mm empfohlen. - Se recomienda la colocación con juntas de 2 mm. - Рекомендуется укладка с швом 2 мм.

TELE DI MARMO

COLORI E FORMATI

Colours and Sizes | Couleurs et Formats | Farben und Formate | Colores y Tamaños | Цвета и Форматы

6,5 mm.



Full Lappato Rett.
120x278 - 47^{1/4} x 109^{7/16}
EJP8 Statuario Michel. ● **T116**

Bookmatch Full Lappato Rett.
120x278 - 47^{1/4} x 109^{7/16}
EJPT Statuario Michel.
Book Match A ● **T116**
EJPU Statuario Michel.
Book Match B ● **T116**



Doghe Full Lappato Rett.
120x278 - 47^{1/4} x 109^{7/16}
EJPA Statuario Michel. ● **T116**



Full Lappato Rett.
120x240 - 47^{1/4} x 94^{1/2}
ED2V Statuario Michel. ● **T114**

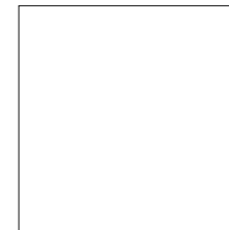

Full Lappato Rett.
120x120 - 47^{1/4} x 47^{1/4}
ED2D Statuario Michel. ● **T110**

Verificare l'abbinamento dei toni tra i formati differenti. - Check the colour matching between different sizes.
Vérifier l'assortiment des tonalités entre les différents formats. - Die Kombination der Farbtöne unter den verschiedenen Formaten prüfen.
Comprobar la combinación de los tonos entre los distintos formatos. - Проверьте сочетание тонов у разных форматов.

TELE DI MARMO

COLORI E FORMATI

Colours and Sizes | Couleurs et Formats | Farben und Formate | Colores y Tamaños | Цвета и Форматы

Statuario Michelangelo



Doghe



Battuto di listelli



Seminato di tessere



Si consiglia la posa con fuga 2 mm. - Laying with a 2 mm-joint is recommended. - Pose recommandée avec joints de 2 mm.
Es wird eine Fugenbreite von 2 mm empfohlen. - Se recomienda la colocación con juntas de 2 mm. - Рекомендуется укладка с швом 2 мм.

TELE DI MARMO

COLORI E FORMATI

Colours and Sizes | Couleurs et Formats | Farben und Formate | Colores y Tamaños | Цвета и Форматы

10,5 mm.



Full Lappato Rett.
90x180 - 35^{7/16}"x70^{7/8}"
EJVH Statuario Michel. ● T93

9,5 mm.



Full Lappato Rett.
90x90 - 35^{7/16}"x35^{7/16}"
ED3C Statuario Michel. ● T77



Full Lappato Rett.
60x120 - 23^{5/8}"x47^{1/4}"
ED3R Statuario Michel. ● T74

Naturale Rett.
60x120 - 23^{5/8}"x47^{1/4}"
ED47 Statuario Michel. ● T31



Full Lappato Rett.
30x60 - 11^{13/16}"x23^{5/8}"
EEPX Statuario Michel. ● T42

Naturale Rett.
30x60 - 11^{13/16}"x23^{5/8}"
ED3M Statuario Michel. ● T14



Naturale Rett.
7,5x30 - 2^{15/16}"x11^{13/16}"
EDMG Statuario Michel. ● T61

Doghe Full Lappato Rett.
60x120 - 23^{5/8}"x47^{1/4}"
ED3U Statuario Michelangelo ● T74



Battuto di listelli Full Lapp. Rett.
60x120 - 23^{5/8}"x47^{1/4}"
ED3S Statuario Michelangelo ● T74



Seminato di tessere Full Lapp. Rett.
60x120 - 23^{5/8}"x47^{1/4}"
ED3T Statuario Michelangelo ● T74

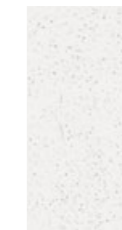

Verificare l'abbinamento dei toni tra i formati differenti. - Check the colour matching between different sizes.
Vérifier l'assortiment des tonalités entre les différents formats. - Die Kombination der Farbtöne unter den verschiedenen Formaten prüfen.
Comprobar la combinación de los tonos entre los distintos formatos. - Проверьте сочетание тонов у разных форматов.

TELE DI MARMO

COLORI E FORMATI

Colours and Sizes | Couleurs et Formats | Farben und Formate | Colores y Tamaños | Цвета и Форматы

Breccia Braque



Frappuccino Pollock







Si consiglia la posa con fuga 2 mm. - Laying with a 2 mm-joint is recommended. - Pose recommandée avec joints de 2 mm.
Es wird eine Fugenbreite von 2 mm empfohlen. - Se recomienda la colocación con juntas de 2 mm. - Рекомендуется укладка с швом 2 мм.

TELE DI MARMO

COLORI E FORMATI

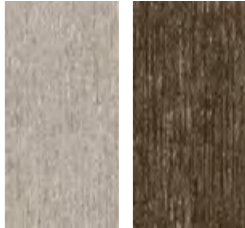
Colours and Sizes | Couleurs et Formats | Farben und Formate | Colores y Tamaños | Цвета и Форматы

	6,5 mm.	Full Lappato Rett. 120x278 - 47 ^{1/4} "x109 ^{7/16} "			
		EJWP Breccia Braque ● T116 EJWR Frapp. Pollock ● T116			
	9,5 mm.	Full Lappato Rett. 90x90 - 35 ^{7/16} "x35 ^{7/16} "			
		ED3E Breccia Braque ● T77 ED3D Frapp. Pollock ● T77			
	Full Lappato Rett. 60x120 - 23 ^{5/8} "x47 ^{1/4} "	Naturale Rett. 60x120 - 23 ^{5/8} "x47 ^{1/4} "			
	ED3Z Breccia Braque ● T74 ED3V Frapp. Pollock ● T74	ED49 Breccia Braque ● T31 ED48 Frapp. Pollock ● T31			
	Full Lappato Rett. 30x60 - 11 ^{13/16} "x23 ^{5/8} "	Naturale Rett. 30x60 - 11 ^{13/16} "x23 ^{5/8} "			
	EEPY Breccia Braque ● T42 EEPZ Frapp. Pollock ● T42	ED3P Breccia Braque ● T14 ED3N Frapp. Pollock ● T14			
		Naturale Rett. 7,5x30 - 2 ^{15/16} "x11 ^{13/16} "			
		EDMJ Breccia Braque ● T61 EDMH Frapp. Pollock ● T61			

Verificare l'abbinamento dei toni tra i formati differenti. - Check the colour matching between different sizes.
Vérifier l'assortiment des tonalités entre les différents formats. - Die Kombination der Farbtöne unter den verschiedenen Formaten prüfen.
Comprobar la combinación de los tonos entre los distintos formatos. - Проверьте сочетание тонов у разных форматов.

TELE DI MARMO

COLORI E FORMATI

Colours and Sizes | Couleurs et Formats | Farben und Formate | Colores y Tamaños | Цвета и Форматы

Calacatta Renoir



Doghe

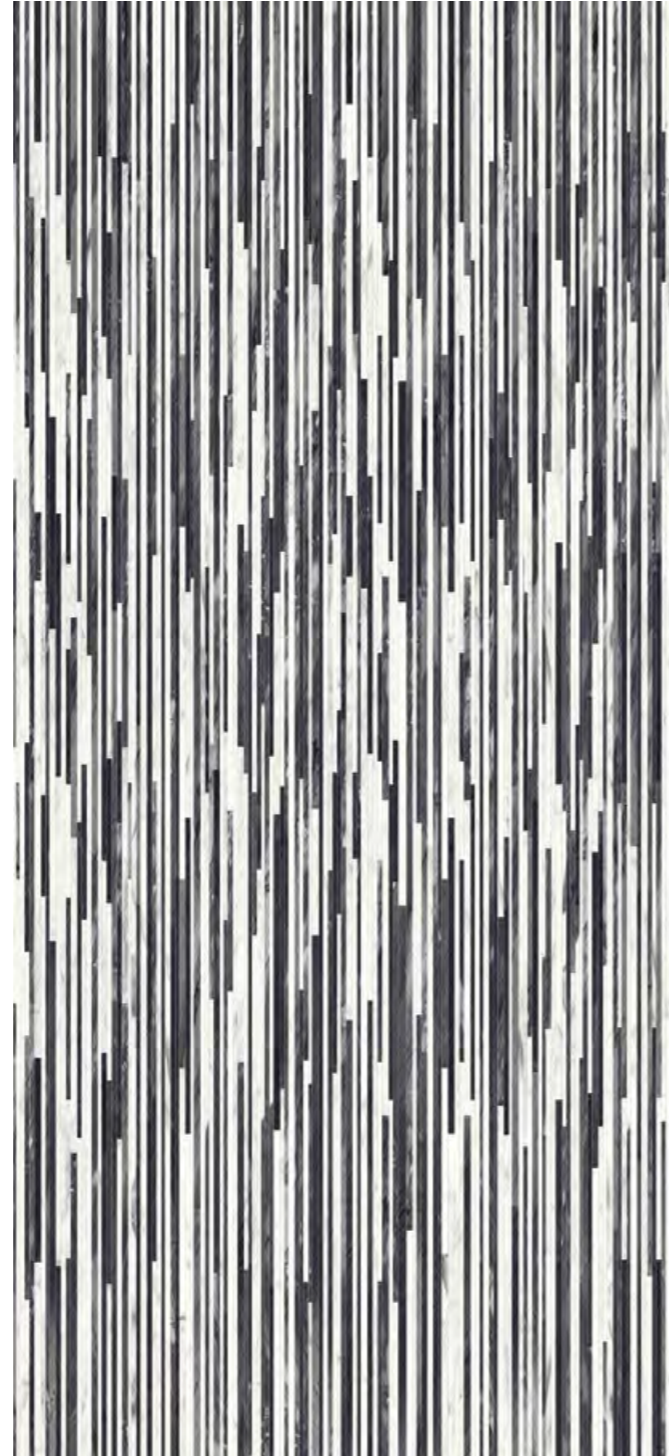

Si consiglia la posa con fuga 2 mm. - Laying with a 2 mm-joint is recommended. - Pose recommandée avec joints de 2 mm.
Es wird eine Fugenbreite von 2 mm empfohlen. - Se recomienda la colocación con juntas de 2 mm. - Рекомендуется укладка с швом 2 мм.

TELE DI MARMO

COLORI E FORMATI

Colours and Sizes | Couleurs et Formats | Farben und Formate | Colores y Tamaños | Цвета и Форматы

6,5 mm.



Full Lappato Rett.

120x278 - 47^{1/4}"x109^{7/16}"

EJWS Calacatta Renoir ● T116

Bookmatch Full Lappato Rett.

120x278 - 47^{1/4}"x109^{7/16}"

EJWT Calacatta Renoir Book Match A ● T116

EJWU Calacatta Renoir Book Match B ● T116

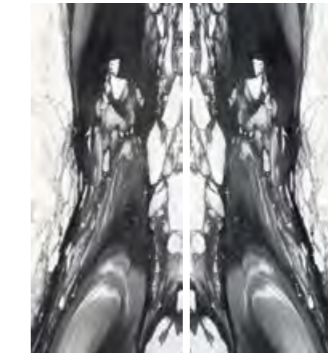

Doghe Full Lappato Rett.

120x278 - 47^{1/4}"x109^{7/16}"

EJWW Calacatta Renoir ● T116

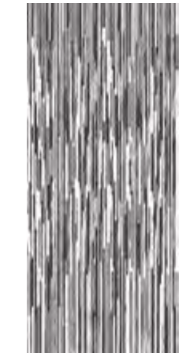

9,5 mm.



Full Lappato Rett.

90x90 - 35^{7/16}"x35^{7/16}"

ED3F Calacatta Renoir ● T77

Doghe Full Lappato Rett.

60x120 - 23^{5/8}"x47^{1/4}"

ED46 Calacatta Renoir ● T74

Full Lappato Rett.

60x120 - 23^{5/8}"x47^{1/4}"

ED43 Calacatta Renoir ● T74

Naturale Rett.

60x120 - 23^{5/8}"x47^{1/4}"

ED4A Calacatta Renoir ● T31

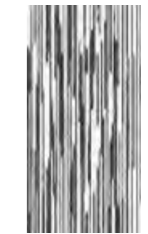

Full Lappato Rett.

30x60 - 11^{13/16}"x23^{5/8}"

EEQ0 Calacatta Renoir ● T42

Naturale Rett.

30x60 - 11^{13/16}"x23^{5/8}"

ED3Q Calacatta Renoir ● T14



Naturale Rett.

7,5x30 - 2^{5/16}"x11^{13/16}"

EDMK Calacatta Renoir ● T61

Verificare l'abbinamento dei toni tra i formati differenti. - Check the colour matching between different sizes.
Vérifier l'assortiment des tonalités entre les différents formats. - Die Kombination der Farbtöne unter den verschiedenen Formaten prüfen.
Comprobar la combinación de los tonos entre los distintos formatos. - Проверьте сочетание тонов у разных форматов.

TELE DI MARMO

DECORI

Decors | Decors | Dekore | Decorados | Декоры

TRAMA*



31,9x28,3 - 12⁹/₁₆"x11¹/₈"

EDPP
Statuario Michel. Nat. ● **A96**
EEGW
Statuario M. Full Lapp. ● **A100**



31,9x28,3 - 12⁹/₁₆"x11¹/₈"

EDPR
Breccia Braque Nat. ● **A96**
EEGX
Breccia B. Full Lapp. ● **A100**



31,9x28,3 - 12⁹/₁₆"x11¹/₈"

EDPQ
Frappuccino Pollock Nat. ● **A96**
EEGY
Frappuccino P. Full Lapp. ● **A100**



31,9x28,3 - 12⁹/₁₆"x11¹/₈"

EDPS
Calacatta Renoir Nat. ● **A96**
EEGZ
Calacatta R. Full Lapp. ● **A100**

INTRECCI*



30x30 - 11¹³/₁₆"x11¹³/₁₆"

EDT9
Statuario Michel. Nat. ● **A100**
EEHQ
Statuario M. Full Lapp. ● **A102**



30x30 - 11¹³/₁₆"x11¹³/₁₆"

EDTC
Breccia Braque Nat. ● **A100**
EEHR
Breccia B. Full Lapp. ● **A102**



30x30 - 11¹³/₁₆"x11¹³/₁₆"

EDTA
Frappuccino Pollock Nat. ● **A100**
EEHS
Frappuccino P. Full Lapp. ● **A102**



30x30 - 11¹³/₁₆"x11¹³/₁₆"

EDTD
Calacatta Renoir Nat. ● **A100**
EEHT
Calacatta R. Full Lapp. ● **A102**

LOSANGHE XS*



28,2x29,1 - 11¹/₈"x11⁷/₁₆"

EDT1
Statuario M. Full Lapp. ● **A110**



28,2x29,1 - 11¹/₈"x11⁷/₁₆"

EDT3
Breccia B. Full Lapp. ● **A110**



28,2x29,1 - 11¹/₈"x11⁷/₁₆"

EDT2
Frappuccino P. Full Lapp. ● **A110**



28,2x29,1 - 11¹/₈"x11⁷/₁₆"

EDT4
Calacatta R. Full Lapp. ● **A110**

* Su rete in fibra - On fibre mesh backing - Sur filet en fibre de verre - Auf Glasfasernetz - Sobre malla de fibra - На волоконной сетке

TELE DI MARMO

DECORI

Decors | Decors | Dekore | Decorados | Декоры

MOSAICO 3X3*

Tessera - Chip 2,8x2,8 - 1¹/₈"x1¹/₈"

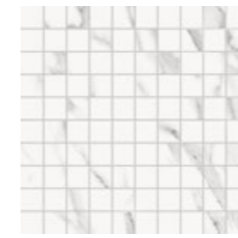

30x30 - 11¹³/₁₆"x11¹³/₁₆"

EDQ5
Statuario Michel. Nat. ● **A96**
EDQ6
Statuario M. Full Lapp. ● **A100**



30x30 - 11¹³/₁₆"x11¹³/₁₆"

EDQ9
Breccia Braque Nat. ● **A96**
EDQA
Breccia B. Full Lapp. ● **A100**

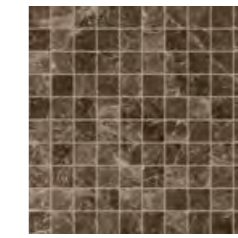

30x30 - 11¹³/₁₆"x11¹³/₁₆"

EDQ7
Frappuccino Pollock Nat. ● **A96**
EDQ8
Frappuccino P. Full Lapp. ● **A100**

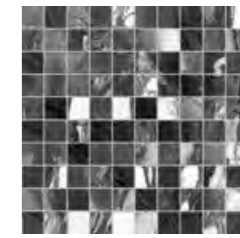

30x30 - 11¹³/₁₆"x11¹³/₁₆"

EDQC
Calacatta Renoir Nat. ● **A96**
EDQD
Calacatta R. Full Lapp. ● **A100**

MOSAICO 5X5*

Tessera - Chip 4,8x4,8 - 1⁷/₈"x1⁷/₈"

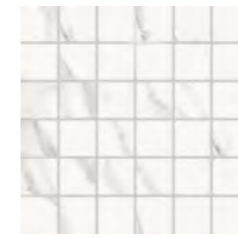

30x30 - 11¹³/₁₆"x11¹³/₁₆"

EDRK
Statuario Michel. Nat. ● **A86**
EEHA
Statuario M. Full Lapp. ● **A90**



30x30 - 11¹³/₁₆"x11¹³/₁₆"

EDRM
Breccia Braque Nat. ● **A86**
EEHC
Breccia B. Full Lapp. ● **A90**

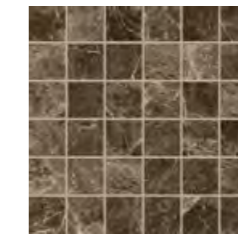

30x30 - 11¹³/₁₆"x11¹³/₁₆"

EDRL
Frappuccino Pollock Nat. ● **A86**
EEHD
Frappuccino P. Full Lapp. ● **A90**

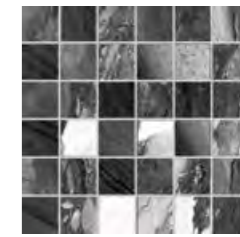

30x30 - 11¹³/₁₆"x11¹³/₁₆"

EDRN
Calacatta Renoir Nat. ● **A86**
EEHE
Calacatta R. Full Lapp. ● **A90**

LOSANGHE XL*



28,2x29,1 - 11¹/₈"x11⁷/₁₆"

EDT5
Statuario M. Full Lapp. ● **A106**



28,2x29,1 - 11¹/₈"x11⁷/₁₆"

EDT7
Breccia B. Full Lapp. ● **A106**



28,2x29,1 - 11¹/₈"x11⁷/₁₆"

EDT6
Frappuccino P. Full Lapp. ● **A106**



28,2x29,1 - 11¹/₈"x11⁷/₁₆"









EDT8
Calacatta R. Full Lapp. ● **A106**

* Su rete in fibra - On fibre mesh backing - Sur filet en fibre de verre - Auf Glasfasernetz - Sobre malla de fibra - На волоконной сетке

TELE DI MARMO

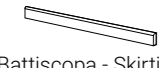
PEZZI SPECIALI

Trims | Pieces Speciales | Formteile | Piezas Especiales | Специальные Изделия

	Dimensione Size	 Statuario Michelangelo	 Breccia Braque	 Frappuccino Pollock	 Calacatta Renoir	Fascia di prezzo Price band				
	Nat. Rett. 7x60 - 2 ^{3/4} x23 ^{5/8} " Pcs. Box 15 - LM x Box 9,00	EDNN	EDNS	EDNQ	EDNU	● A11				
	Full Lapp. Rett. 7x60 - 2 ^{3/4} x23 ^{5/8} " Pcs. Box 15 - LM x Box 9,00	EDNP	EDNT	EDNR	EDNV	● A15				
	Full Lapp. Rett. 4,6x90 - 1 ^{13/16} x35 ^{7/16} " Pcs. Box 8 - LM x Box 7,20	EDL5	EDL9	EDL7	EDLC	● A20				
	Nat. Rett. 33x120x3,2x3,2 12 ^{15/16} x47 ^{1/4} x1 ^{1/4} x1 ^{1/4} " Pcs. Box 2 - LM x Box 2,40	EDM7	EDMC	EDM9	EDME	● A98				
	Full Lapp. Rett. 33x120x3,2x3,2 12 ^{15/16} x47 ^{1/4} x1 ^{1/4} x1 ^{1/4} " Pcs. Box 2 - LM x Box 2,40	EDM8	EDMD	EDMA	EDMF	● A101				
	Nat. Rett. 33x120x3,2x3,2 12 ^{15/16} x47 ^{1/4} x1 ^{1/4} x1 ^{1/4} " Pcs. Box 1 - LM x Box 1,20	DX EDKG	SX EDKH	DX EDKQ	SX EDKR	DX EDKL	SX EDKM	DX EDKU	SX EDKV	● A104
	Full Lapp. Rett. 33x120x3,2x3,2 12 ^{15/16} x47 ^{1/4} x1 ^{1/4} x1 ^{1/4} " Pcs. Box 1 - LM x Box 1,20	DX EDKJ	SX EDKK	DX EDKS	SX EDKT	DX EDKN	SX EDKP	DX EDKW	SX EDKX	● A106
	Nat. Rett. 15x15 - 5 ^{7/8} x5 ^{7/8} " Pcs. Box 16	EDTM	EDTP	EDTN	EDTQ	● A11				
	Nat. Rett. 15x15 - 5 ^{7/8} x5 ^{7/8} " Pcs. Box 4	EDTZ	EDU1	EDU0	EDU2	● A19				



TELE DI MARMO

IMBALLI E PESI

Packing and Weight | Emballages et Poids | Verpackung und Gewicht | Embalajes y Pesos | Упаковка и Вес

Formato Size Format Format Tamaño Формат cm	Spessore Thickness Epaisseur Stärke Espesor Толщина mm	Pz. x Mq. Pieces x Sqm Pcs / M ² Stk. x Qm Pzs x Mc. Шт x Кв.М.	Pz. x Scat. Pieces x Box Pcs / Bte Stk. x Krt. Pzs x Caja Шт x Кор.	Mq. x Scat. Sqm x Box M ² / Bte Qm x Krt. Mc. x Caja Кв.М. x Кор.	Peso x Scat. Weight x Box Poids / Bte Gewicht x Krt. Peso x Caja Вес x Кор. Kg	Scat. x Pal. Boxes x Pal. Bte / Pal. Krt. x Pal. Cajas x Pal. Кор. x Подд.	Mq. x Pal. Sqm x Pal. M ² / Pal. Qm x Pal. Mc. x Pal. Кв.М x Подд.	Peso x Pal. Weight x Pal. Poids / Pal. Gewicht x Pal. Peso x Pal. Вес x Подд. Kg
120x278 Full Lappato	6,5	0,30	1	3,34	50,04			vedi sotto - see below
120x240 Full Lappato	6,5	0,35	1	2,88	43,20			
120x120 Full Lappato	6,5	0,69	2	2,88	43,20	20	57,60	984
90x180 Full Lappato	10,5	0,62	2	3,24	77,76	18	58,32	1400
90x90 Full Lappato	9,5	1,23	2	1,62	35,64	24	38,88	855
60x120 Nat. - Full Lappato	9,5	1,39	2	1,44	31,68	36	51,84	1140
30x60 Nat. - Full Lappato	9,5	5,56	6	1,08	23,76	48	51,84	1140
7,5x30 Naturale	9,5	44,44	36	0,81	17,82	56	45,36	998
31,9x28,3 Trama Nat. - Full Lappato	9,5	11,08	5	0,45	8,73	60	27,00	524
30x30 Mosaico 5X5 Nat. - Full Lappato	9,5	11,11	5	0,45	8,73	60	27,00	524
30x30 Mosaico 3X3 Nat. - Full Lappato	9,5	11,11	5	0,45	8,73	60	27,00	524
30x30 Intrecci Nat. - Full Lappato	9,5	11,11	5	0,45	8,73	60	27,00	524
28,2x29,1 Losanghe XS/XL Full Lapp.	9,5	12,19	5	0,41	10,00	60	24,60	600

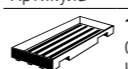
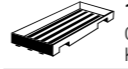
Slabs 120x278 - 120x240 - 120x120

Articolo Item Reference Artikel Articulo Артикула	Dimensione (cm) Size (cm) Format (cm) Format (cm) Tamaño (cm) Формат (cm)	Nr. Lastre No. of Slabs Nbre Dalles Anz. Platten Nº de Placas Кол. Плит	Mq. x Imballo sqm per Pack M ² / Emballage qm pro Verpackung M ² por embalaje Кв.м. x упаковку	Peso Imballo (Kg) Weight of Packaging (kg) Poids Emballage (kg) Gewicht Verpackung (kg) Peso embalaje (kg) Вес упаковки (кг)	Peso Imballo+Lastre (Kg) Weight of Packaging + Slabs (kg) Poids Emballage+Dalles (kg) Gewicht Verpackung+Platten (kg) Peso embalaje + placas (kg) Вес упаковки + плит (кг)
 120x278	136,5x291,5x41,5h	18	60,05	120	1081
 120x240	136x266x18h	20	57,60	99	1020,6
 120x278	75x290x160h	40	133,44	180	2315
 120x240	75x250x159,6h	48	138,24	163	2375



PRODUCT CERTIFIED FOR LOW CHEMICAL EMISSIONS: ULCDM/CG UL 2818

FORMATI

Sizes | Formats | Formate | Tamaños | Форматы

6,5 mm.

120x278 - 47^{1/4}"x109^{7/16}" Full Lappato

120x240 - 47^{1/4}"x94^{1/2}" Full Lappato

120x120 - 47^{1/4}"x47^{1/4}" Full Lappato

10,5 mm.

90x180 - 35^{7/16}"x70^{7/8}" Full Lappato

9,5 mm.

90x90 - 35^{7/16}"x35^{7/16}" Full Lappato

60x120 - 23^{5/8}"x47^{1/4}" Naturale - Full Lappato

30x60 - 11^{13/16}"x23^{5/8}" Naturale - Full Lappato

7,5x30 - 2^{15/16}"x11^{13/16}" Naturale

SUPERFICI

Finishes | Finitions | Oberflächen
Superficies | Отделка поверхности

NATURALE

R9 DIN 51130

- DIN 51097

Wet \geq 0,42 DCOF

\geq 0,40 B.C.R.A.

- Pendolo AS 4586

- Pendolo BS 7976

- Pendolo UNE 41901

FULL LAPPATO

- DIN 51130

- DIN 51097

- DCOF

- B.C.R.A.

- Pendolo AS 4586

- Pendolo BS 7976

- Pendolo UNE 41901

SHADE VARIATIONS



V3 HIGH

DESTINAZIONI D'USO

Intended uses | Domaines d'application
Zweckbestimmung | Usos previstos | Назначение



品質性水平高



QUARZO KANDINSKY



Battuto di listelli



Seminato di tessere



Doghe



CALACATTA GOLD CANOVA



Doghe



FOSSIL BROWN MALEVIC

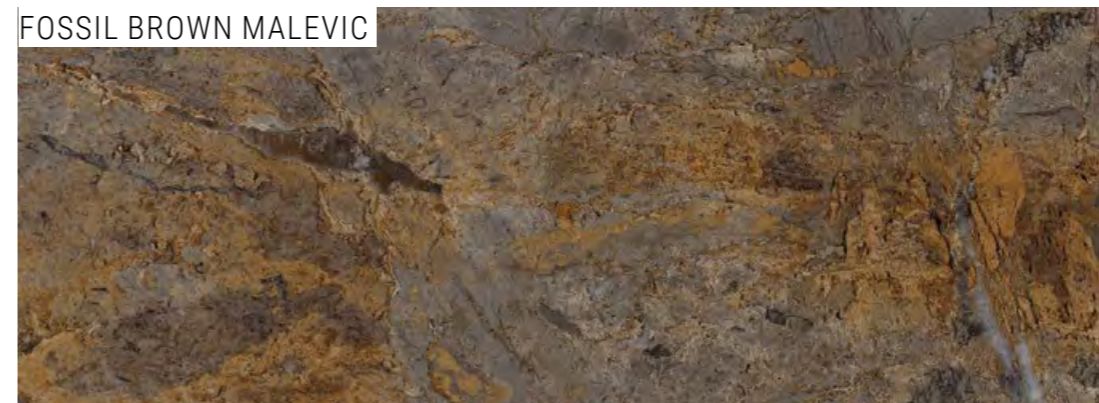

Doghe



ONICE KLIMT



Doghe

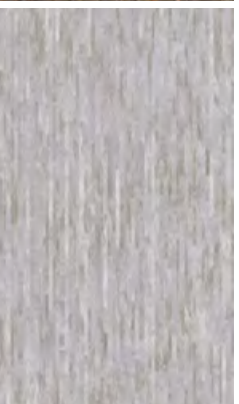

MARFIL ORDÓÑEZ

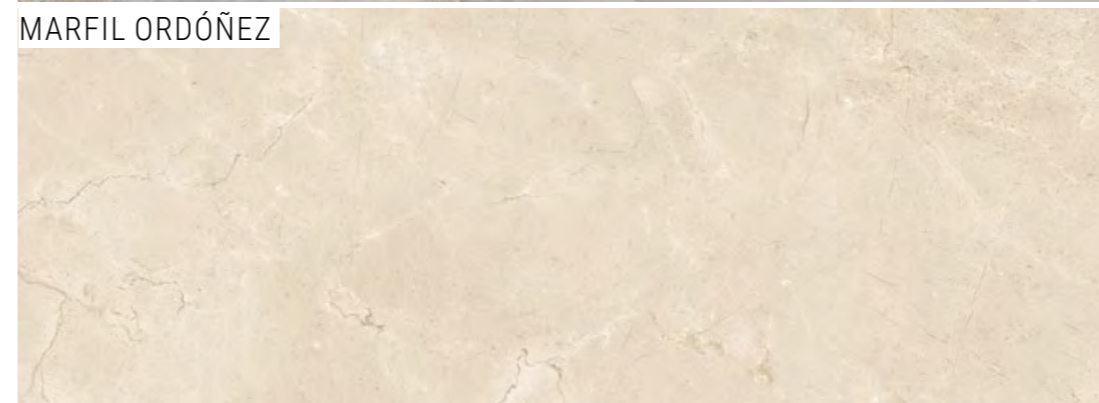

Doghe



TELE DI MARMO RELOADED

COLORI E FORMATI

Colours and Sizes | Couleurs et Formats | Farben und Formate | Colores y Tamaños | Цвета и Форматы

Quarzo Kandinsky



Doghe



TELE DI MARMO RELOADED

COLORI E FORMATI

Colours and Sizes | Couleurs et Formats | Farben und Formate | Colores y Tamaños | Цвета и Форматы

6,5 mm.



Full Lappato Rett.

120x278 - 47^{1/4} x 109^{7/16}

EJP4 Quarzo Kandinsky ● **T116**

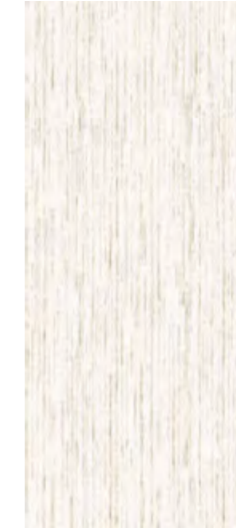

Doghe Full Lappato Rett.

120x278 - 47^{1/4} x 109^{7/16}

EJP6 Quarzo Kandinsky ● **T116**



Full Lappato Rett.

120x240 - 47^{1/4} x 94^{1/2}

E04N Quarzo Kandinsky ● **T114**

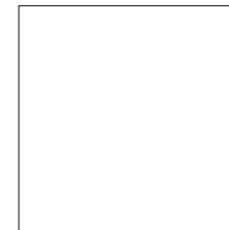

Full Lappato Rett.

120x120 - 47^{1/4} x 47^{1/4}

E04U Quarzo Kandinsky ● **T110**

Si consiglia la posa con fuga 2 mm. - Laying with a 2 mm-joint is recommended. - Pose recommandée avec joints de 2 mm.
Es wird eine Fugenbreite von 2 mm empfohlen. - Se recomienda la colocación con juntas de 2 mm. - Рекомендуется укладка с швом 2 мм.

Verificare l'abbinamento dei toni tra i formati differenti. - Check the colour matching between different sizes.
Vérifier l'assortiment des tonalités entre les différents formats. - Die Kombination der Farbtöne unter den verschiedenen Formaten prüfen.
Comprobar la combinación de los tonos entre los distintos formatos. - Проверьте сочетание тонов у разных форматов.

TELE DI MARMO RELOADED

COLORI E FORMATI

Colours and Sizes | Couleurs et Formats | Farben und Formate | Colores y Tamaños | Цвета и Форматы

Quarzo Kandinsky



Doghe



Battuto di listelli



Seminato di tessere



Si consiglia la posa con fuga 2 mm. - Laying with a 2 mm-joint is recommended. - Pose recommandée avec joints de 2 mm.
Es wird eine Fugenbreite von 2 mm empfohlen. - Se recomienda la colocación con juntas de 2 mm. - Рекомендуется укладка с швом 2 мм.

TELE DI MARMO RELOADED

COLORI E FORMATI

Colours and Sizes | Couleurs et Formats | Farben und Formate | Colores y Tamaños | Цвета и Форматы

10,5 mm.



Full Lappato Rett.
90x180 - 35^{7/16}"x70^{7/8}"
EJVK Quarzo Kandinsky ● T93

9,5 mm.



Full Lappato Rett.
90x90 - 35^{7/16}"x35^{7/16}"
E0EJ Quarzo Kandinsky ● T77

Full Lappato Rett.
60x120 - 23^{5/8}"x47^{1/4}"
E0E5 Quarzo Kandinsky ● T74



Naturale Rett.
60x120 - 23^{5/8}"x47^{1/4}"
E0EQ Quarzo Kandinsky ● T31

Full Lappato Rett.
30x60 - 11^{13/16}"x23^{5/8}"
E0EC Quarzo Kandinsky ● T42



Naturale Rett.
30x60 - 11^{13/16}"x23^{5/8}"
E0EW Quarzo Kandinsky ● T14



Naturale Rett.
7,5x30 - 2^{15/16}"x11^{13/16}"
E0F2 Quarzo Kandinsky ● T61

Doghe Full Lappato Rett.
60x120 - 23^{5/8}"x47^{1/4}"
E0FM Quarzo Kandinsky ● T74



Battuto di listelli Full Lapp. Rett.
60x120 - 23^{5/8}"x47^{1/4}"
E0FF Quarzo Kandinsky ● T74



Seminato di tessere Full Lapp. Rett.
60x120 - 23^{5/8}"x47^{1/4}"
E0F8 Quarzo Kandinsky ● T74

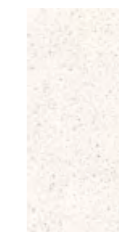

Verificare l'abbinamento dei toni tra i formati differenti. - Check the colour matching between different sizes.
Vérifier l'assortiment des tonalités entre les différents formats. - Die Kombination der Farbtöne unter den verschiedenen Formaten prüfen.
Comprobar la combinación de los tonos entre los distintos formatos. - Проверьте сочетание тонов у разных форматов.

TELE DI MARMO RELOADED

COLORI E FORMATI

Colours and Sizes | Couleurs et Formats | Farben und Formate | Colores y Tamaños | Цвета и Форматы

Calacatta Gold Canova



Doghe











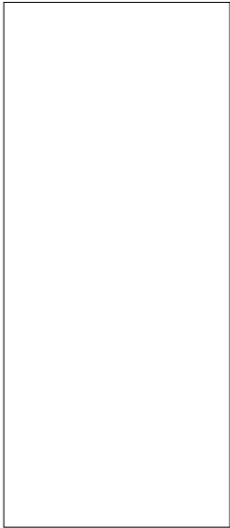



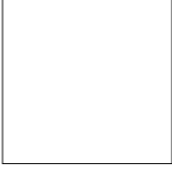

Si consiglia la posa con fuga 2 mm. - Laying with a 2 mm-joint is recommended. - Pose recommandée avec joints de 2 mm.
Es wird eine Fugenbreite von 2 mm empfohlen. - Se recomienda la colocación con juntas de 2 mm. - Рекомендуется укладка с швом 2 мм.

TELE DI MARMO RELOADED

COLORI E FORMATI

Colours and Sizes | Couleurs et Formats | Farben und Formate | Colores y Tamaños | Цвета и Форматы

	6,5 mm.	Full Lappato Rett. 120x278 - 47 ^{1/4} "x109 ^{7/16} " EJPK Calacatta Gold C. ● T116	Bookmatch Full Lappato Rett. 120x278 - 47 ^{1/4} "x109 ^{7/16} " EJPK Calacatta Gold C. ● T116 Book Match A ● T116 EJPR Calacatta Gold C. ● T116 Book Match B ● T116	Doghe Full Lappato Rett. 120x278 - 47 ^{1/4} "x109 ^{7/16} " EJPM Calacatta Gold C. ● T116
				
	10,5 mm.	Full Lappato Rett. 90x180 - 35 ^{7/16} "x70 ^{7/8} " EJVL Calacatta Gold C. ● T93		
				
	9,5 mm.	Full Lappato Rett. 90x90 - 35 ^{7/16} "x35 ^{7/16} " E0EK Calacatta Gold C. ● T77		
				
	Full Lappato Rett. 60x120 - 23 ^{5/8} "x47 ^{1/4} " E0E6 Calacatta Gold C. ● T74	Naturale Rett. 60x120 - 23 ^{5/8} "x47 ^{1/4} " E0ER Calacatta Gold C. ● T31		Doghe Full Lappato Rett. 60x120 - 23 ^{5/8} "x47 ^{1/4} " E0FN Calacatta Gold C. ● T74
				
	Full Lappato Rett. 30x60 - 11 ^{13/16} "x23 ^{5/8} " E0ED Calacatta Gold C. ● T42	Naturale Rett. 30x60 - 11 ^{13/16} "x23 ^{5/8} " E0EX Calacatta Gold C. ● T14		
				
		Naturale Rett. 7,5x30 - 2 ^{15/16} "x11 ^{13/16} " E0F3 Calacatta Gold C. ● T61		
				

Verificare l'abbinamento dei toni tra i formati differenti. - Check the colour matching between different sizes.
Vérifier l'assortiment des tonalités entre les différents formats. - Die Kombination der Farbtöne unter den verschiedenen Formaten prüfen.
Comprobar la combinación de los tonos entre los distintos formatos. - Проверьте сочетание тонов у разных форматов.

TELE DI MARMO RELOADED

COLORI E FORMATI

Colours and Sizes | Couleurs et Formats | Farben und Formate | Colores y Tamaños | Цвета и Форматы

Fossil Brown Malevic



Doghe



Onice Klimt



Doghe



Marfil Ordóñez

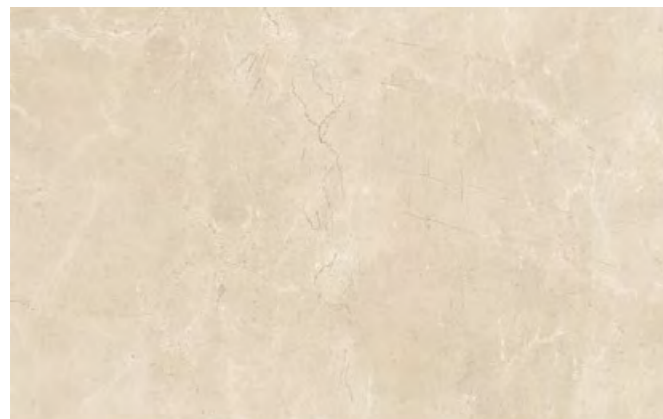

Doghe



Si consiglia la posa con fuga 2 mm. - Laying with a 2 mm-joint is recommended. - Pose recommandée avec joints de 2 mm.
Es wird eine Fugenbreite von 2 mm empfohlen. - Se recomienda la colocación con juntas de 2 mm. - Рекомендуется укладка с швом 2 мм.

TELE DI MARMO RELOADED

COLORI E FORMATI

Colours and Sizes | Couleurs et Formats | Farben und Formate | Colores y Tamaños | Цвета и Форматы

6,5 mm.



Full Lappato Rett.

120x278 - 47^{1/4}"x109^{7/16}"

EJWY Fossil Brown Mal. ● T116

EJWZ Onice Klimt ● T116

EJX0 Marfil Ordóñez ● T116

9,5 mm.

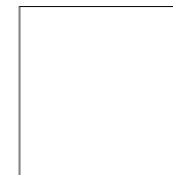

Full Lappato Rett.

90x90 - 35^{7/16}"x35^{7/16}"

E0EL Fossil Brown Mal. ● T77

E0EM Onice Klimt ● T77

E0EN Marfil Ordóñez ● T77

Doghe Full Lappato Rett.

60x120 - 23^{5/8}"x47^{1/4}"

E0FP Fossil Brown Mal. ● T74

E0FQ Onice Klimt ● T74

E0FR Marfil Ordóñez ● T74

Full Lappato Rett.

60x120 - 23^{5/8}"x47^{1/4}"

E0E7 Fossil Brown Mal. ● T74

E0E8 Onice Klimt ● T74

E0E9 Marfil Ordóñez ● T74

Naturale Rett.

60x120 - 23^{5/8}"x47^{1/4}"

E0ES Fossil Brown Mal. ● T31

E0ET Onice Klimt ● T31

E0EU Marfil Ordóñez ● T31

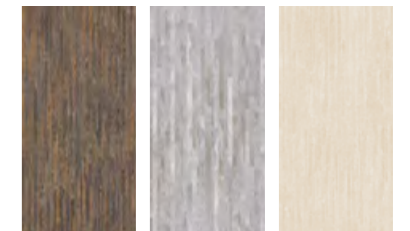

Full Lappato Rett.

30x60 - 11^{13/16}"x23^{5/8}"

E0EE Fossil Brown Mal. ● T42

E0EF Onice Klimt ● T42

E0EG Marfil Ordóñez ● T42

Naturale Rett.

30x60 - 11^{13/16}"x23^{5/8}"

E0EY Fossil Brown Mal. ● T14

E0EZ Onice Klimt ● T14

E0F0 Marfil Ordóñez ● T14



Naturale Rett.

7,5x30 - 2^{15/16}"x11^{13/16}"

E0F4 Fossil Brown Mal. ● T61

E0F5 Onice Klimt ● T61

E0F6 Marfil Ordóñez ● T61

Verificare l'abbinamento dei toni tra i formati differenti. - Check the colour matching between different sizes.
Vérifier l'assortiment des tonalités entre les différents formats. - Die Kombination der Farbtöne unter den verschiedenen Formaten prüfen.
Comprobar la combinación de los tonos entre los distintos formatos. - Проверьте сочетание тонов у разных форматов.

TELE DI MARMO RELOADED

DECORI

Decors | Decors | Dekore | Decorados | Декоры

INTRECCI*



30x30 - 11^{13/16}"x11^{13/16}"
EORX Quarzo Kandinsky Nat. ● **A100**
EOR3 Quarzo Kandinsky Full Lapp. ● **A102**



30x30 - 11^{13/16}"x11^{13/16}"
EOQY Calacatta Gold Canova Nat. ● **A100**
EOR4 Calacatta Gold Canova Full Lapp. ● **A102**



30x30 - 11^{13/16}"x11^{13/16}"
EOQZ Fossil Brown Malevic Nat. ● **A100**
EOR5 Fossil Brown Malevic Full Lapp. ● **A102**



30x30 - 11^{13/16}"x11^{13/16}"
EOR0 Onice Klimt Nat. ● **A100**
EOR6 Onice Klimt Full Lapp. ● **A102**



30x30 - 11^{13/16}"x11^{13/16}"
EOR1 Marfil Ordóñez Nat. ● **A100**
EOR7 Marfil Ordóñez Full Lapp. ● **A102**

* Su rete in fibra - On fibre mesh backing - Sur filet en fibre de verre - Auf Glasfasernetz - Sobre malla de fibra - На волоконной сетке

TELE DI MARMO RELOADED

DECORI

Decors | Decors | Dekore | Decorados | Декоры

MOSAICO 3X3*

Tessera - Chip 2,8x2,8 - 1^{1/8}"x1^{1/8}"



30x30 - 11^{13/16}"x11^{13/16}"
EOQK Quarzo Kandinsky Nat. ● **A96**
EOQR Quarzo Kandinsky Full Lapp. ● **A100**



30x30 - 11^{13/16}"x11^{13/16}"
EOQL Calacatta Gold Canova Nat. ● **A96**
EOQS Calacatta Gold Canova Full Lapp. ● **A100**

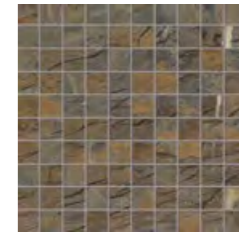

30x30 - 11^{13/16}"x11^{13/16}"
EOQM Fossil Brown Malevic Nat. ● **A96**
EOQT Fossil Brown Malevic Full Lapp. ● **A100**

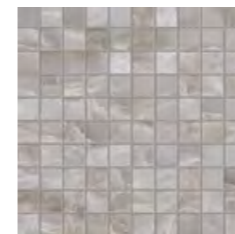

30x30 - 11^{13/16}"x11^{13/16}"
EOQN Onice Klimt Nat. ● **A96**
EOQU Onice Klimt Full Lapp. ● **A100**



30x30 - 11^{13/16}"x11^{13/16}"
EOQP Marfil Ordóñez Nat. ● **A96**
EOQV Marfil Ordóñez Full Lapp. ● **A100**

MOSAICO 5X5*

Tessera - Chip 4,8x4,8 - 1^{7/8}"x1^{7/8}"

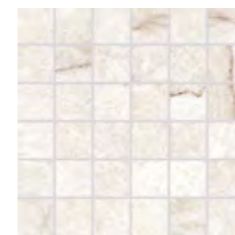

30x30 - 11^{13/16}"x11^{13/16}"
EOQ5 Quarzo Kandinsky Nat. ● **A86**
EOQD Quarzo Kandinsky Full Lapp. ● **A90**



30x30 - 11^{13/16}"x11^{13/16}"
EOQ6 Calacatta Gold Canova Nat. ● **A86**
EOQE Calacatta Gold Canova Full Lapp. ● **A90**

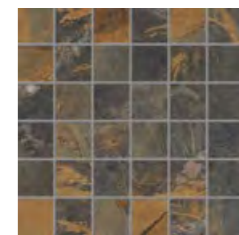

30x30 - 11^{13/16}"x11^{13/16}"
EOQ7 Fossil Brown Malevic Nat. ● **A86**
EOQF Fossil Brown Malevic Full Lapp. ● **A90**

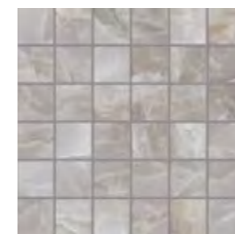

30x30 - 11^{13/16}"x11^{13/16}"
EOQ8 Onice Klimt Nat. ● **A86**
EOQG Onice Klimt Full Lapp. ● **A90**

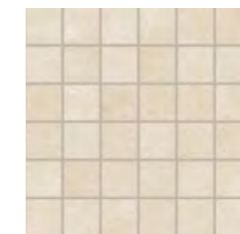









30x30 - 11^{13/16}"x11^{13/16}"
EOQA Marfil Ordóñez Nat. ● **A86**
EOQH Marfil Ordóñez Full Lapp. ● **A90**

* Su rete in fibra - On fibre mesh backing - Sur filet en fibre de verre - Auf Glasfasernetz - Sobre malla de fibra - На волоконной сетке

TELE DI MARMO RELOADED

PEZZI SPECIALI

Trims | Pieces Speciales | Formteile | Piezas Especiales | Специальные Изделия

	Dimensione Size	 Quarzo Kandinsky	 Calacatta Gold Canova	 Fossil Brown Malevic	 Onice Klimt	 Marfil Ordóñez	Fascia di prezzo Price band
	Nat. Rett. 7x60 - 2 ^{3/4} x23 ^{5/8} " Pcs. Box 15 - LM x Box 9,00	E0R9	E0RA	E0RC	E0RD	E0RF	● A11
	Full Lapp. Rett. 7x60 - 2 ^{3/4} x23 ^{5/8} " Pcs. Box 15 - LM x Box 9,00	E0RH	E0RJ	E0RK	E0RL	E0RM	● A15
	Full Lapp. Rett. 4,6x90 - 1 ^{13/16} x35 ^{7/16} " Pcs. Box 8 - LM x Box 7,20	E0RP	E0RQ	E0RR	E0RS	E0RT	● A20
	Nat. Rett. 33x120x3,2x3,2 12 ^{15/16} x47 ^{1/4} x1 ^{1/4} x1 ^{1/4} " Pcs. Box 2 - LM x Box 2,40	E0RV	E0RW	E0RX	E0RY	E0RZ	● A98
	Full Lapp. Rett. 33x120x3,2x3,2 12 ^{15/16} x47 ^{1/4} x1 ^{1/4} x1 ^{1/4} " Pcs. Box 2 - LM x Box 2,40	E0S1	E0S2	E0S3	E0S4	E0S5	● A101
	Nat. Rett. 33x120x3,2x3,2 12 ^{15/16} x47 ^{1/4} x1 ^{1/4} x1 ^{1/4} " Pcs. Box 1 - LM x Box 1,20	DX E0S7	DX E0S8	DX E0S9	DX E0SA	DX E0SC	● A104
	Full Lapp. Rett. 33x120x3,2x3,2 12 ^{15/16} x47 ^{1/4} x1 ^{1/4} x1 ^{1/4} " Pcs. Box 1 - LM x Box 1,20	SX E0SE	SX E0SF	SX E0SG	SX E0SH	SX E0SJ	
	Nat. Rett. 15x15 - 5 ^{7/8} x5 ^{7/8} " Pcs. Box 16	E0SY	E0SZ	E0T0	E0T1	E0T2	● A11
	Nat. Rett. 15x15 - 5 ^{7/8} x5 ^{7/8} " Pcs. Box 4	E0T4	E0T5	E0T6	E0T7	E0T8	● A19



TELE DI MARMO RELOADED

IMBALLI E PESI

Packing and Weight | Emballages et Poids | Verpackung und Gewicht | Embalajes y Pesos | Упаковка и Вес

Formato Size Format Format Tamaño Формат cm	Spessore Thickness Epaisseur Stärke Espesor Толщина mm	Pz. x Mq. Pieces x Sqm Pcs / M ² Stk. x Qm Pzs x Mc. Шт x Кв.М.	Pz. x Scat. Pieces x Box Pcs / Bte Stk. x Krt. Pzs x Caja Шт x Кор.	Mq. x Scat. Sqm x Box M ² / Bte Qm x Krt. Mc. x Caja Кв.М. x Кор.	Peso x Scat. Weight x Box Poids / Bte Gewicht x Krt. Peso x Caja Вес x Кор. Kg	Scat. x Pal. Boxes x Pal. Bte / Pal. Krt. x Pal. Cajas x Pal. Кор. x Подд.	Mq. x Pal. Sqm x Pal. M ² / Pal. Qm x Pal. Mc. x Pal. Кв.М x Подд.	Peso x Pal. Weight x Pal. Poids / Pal. Gewicht x Pal. Peso x Pal. Вес x Подд. Kg
120x278 Full Lappato	6,5	0,30	1	3,34	50,04			vedi sotto - see below
120x240 Full Lappato	6,5	0,35	1	2,88	43,20			
120x120 Full Lappato	6,5	0,69	2	2,88	43,20	20	57,60	984
90x180 Full Lappato	10,5	0,62	2	3,24	77,76	18	58,32	1400
90x90 Full Lappato	9,5	1,23	2	1,62	35,64	24	38,88	855
60x120 Nat. - Full Lappato	9,5	1,39	2	1,44	31,68	36	51,84	1140
30x60 Nat. - Full Lappato	9,5	5,56	6	1,08	23,76	48	51,84	1140
7,5x30 Naturale	9,5	44,44	36	0,81	17,82	56	45,36	998
30x30 Mosaico 5X5 Nat. - Full Lappato	9,5	11,11	5	0,45	8,73	60	27,00	524
30x30 Mosaico 3X3 Nat. - Full Lappato	9,5	11,11	5	0,45	8,73	60	27,00	524
30x30 Intrecci Nat. - Full Lappato	9,5	11,11	5	0,45	8,73	60	27,00	524

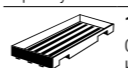
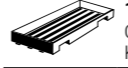
Slabs 120x278 - 120x240 - 120x120

Articolo Item Reference Artikel Articulo Артикула	Dimensione (cm) Size (cm) Format (cm) Format (cm) Tamaño (cm) Формат (cm)	Nr. Lastre No. of Slabs Nbre Dalles Anz. Platten Nº de Placas Кол. Плит	Mq. x Imballo sqm per Pack M ² / Emballage qm pro Verpackung M ² por embalaje Кв.м. x упаковку	Peso Imballo (Kg) Weight of Packaging (kg) Poids Emballage (kg) Gewicht Verpackung (kg) Peso embalaje (kg) Вес упаковки (кг)	Peso Imballo+Lastre (Kg) Weight of Packaging + Slabs (kg) Poids Emballage+Dalles (kg) Gewicht Verpackung+Platten (kg) Peso embalaje + placas (kg) Вес упаковки + плит (кг)
 120x278	136,5x291,5x41,5h	18	60,05	120	1081
 120x240	136x266x18h	20	57,60	99	1020,6
 120x278	75x290x160h	40	133,44	180	2315
 120x240	75x250x159,6h	48	138,24	163	2375

TELE DI *Marmi* REVOLUTION



FORMATI

Sizes | Formats | Formate | Tamaños | Форматы

6,5 mm.

120x278 - 47^{1/4}"x109^{7/16}" Full Lappato

10,5 mm.

90x180 - 35^{7/16}"x70^{7/8}" Full Lappato

9,5 mm.

90x90 - 35^{7/16}"x35^{7/16}" Full Lappato

60x120 - 23^{5/8}"x47^{1/4}" Naturale - Full Lappato

30x60 - 11^{13/16}"x23^{5/8}" Naturale - Full Lappato

SUPERFICI

Finishes | Finitions | Oberflächen
Superficies | Отделка поверхности

NATURALE

R9 DIN 51130

- DIN 51097

Wet \geq 0,42 DCOF

\geq 0,40 B.C.R.A.

- Pendolo AS 4586

- Pendolo BS 7976

- Pendolo UNE 41901

FULL LAPPATO

- DIN 51130

- DIN 51097

- DCOF

- B.C.R.A.

- Pendolo AS 4586

- Pendolo BS 7976

- Pendolo UNE 41901

SHADE VARIATIONS



DESTINAZIONI D'USO

Intended uses | Domaines d'application
Zweckbestimmung | Usos previstos | Назначение



12%
0% Slabs 6,5 mm.

BLU ANDE



Acanto



THASSOS

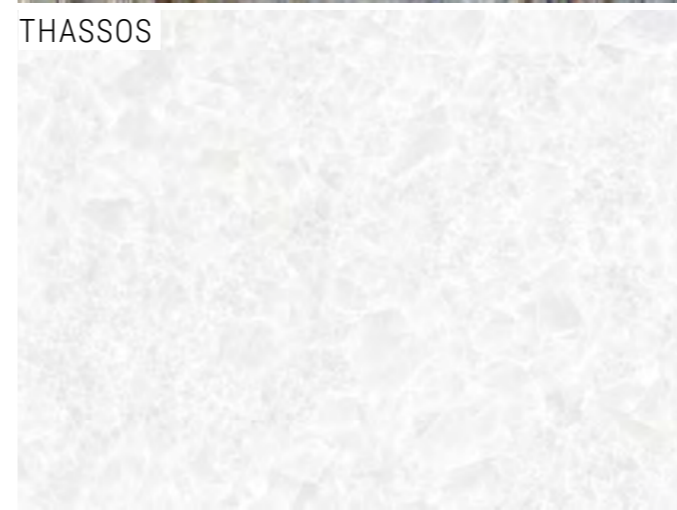

Acanto

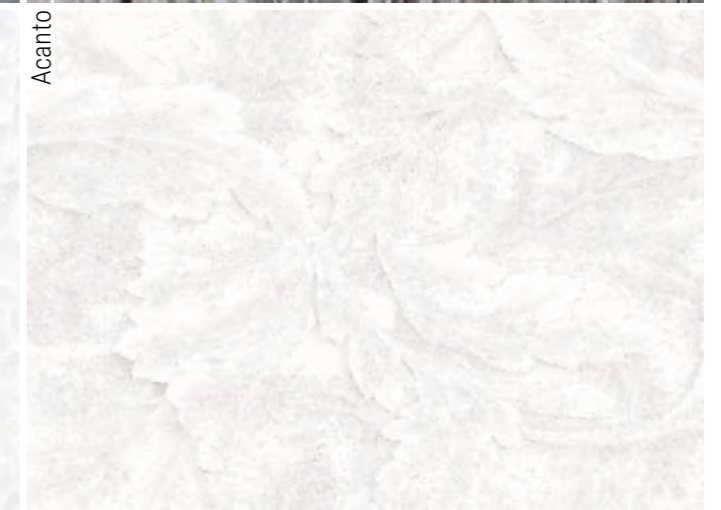

VERDE SAINT DENIS



Acanto



CALACATTA BLACK

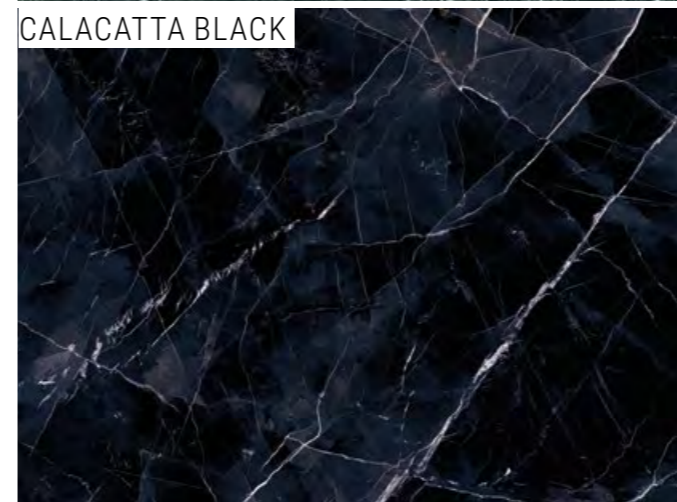

Acanto



TELE DI MARMO REVOLUTION

COLORI E FORMATI

Colours and Sizes | Couleurs et Formats | Farben und Formate | Colores y Tamaños | Цвета и Форматы

Blu Ande



Blu Ande Acanto



Thassos

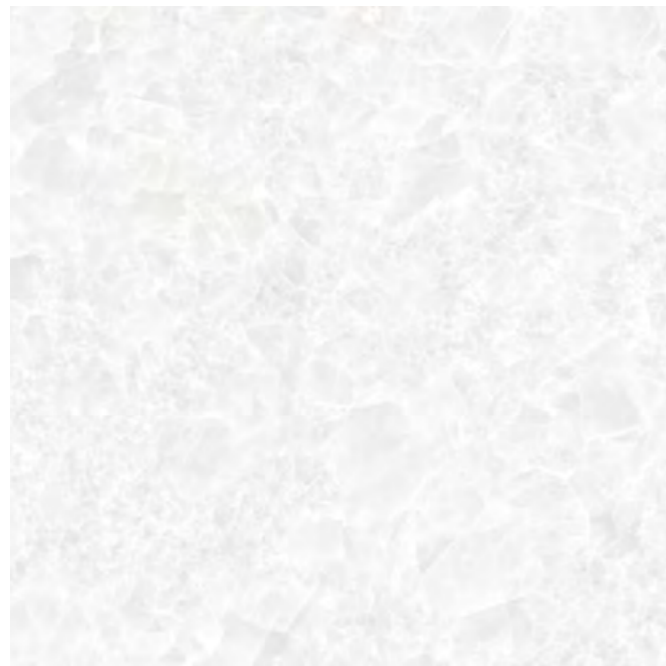

Thassos Acanto



TELE DI MARMO REVOLUTION

COLORI E FORMATI

Colours and Sizes | Couleurs et Formats | Farben und Formate | Colores y Tamaños | Цвета и Форматы

6,5 mm.



Full Lappato Rett.
120x278 - 47^{1/4}"x109^{7/16}"
EHA3 Blu Ande ● T116
EHA2 Thassos ● T116

Acanto Full Lappato Rett.
120x278 - 47^{1/4}"x109^{7/16}"
EHAQ Blu Ande ● T116
EHAP Thassos ● T116



10,5 mm.



Full Lappato Rett.
90x180 - 35^{7/16}"x70^{7/8}"
EJVN Thassos ● T93

9,5 mm.



Full Lappato Rett.
90x90 - 35^{7/16}"x35^{7/16}"
EHA8 Blu Ande ● T77
EHAD Thassos ● T77

Acanto Full Lappato Rett.
60x120 - 23^{5/8}"x47^{1/4}"
EHAV Blu Ande ● T74
EHAU Thassos ● T74



Full Lappato Rett.
60x120 - 23^{5/8}"x47^{1/4}"
EHA8 Blu Ande ● T74
EHA7 Thassos ● T74

Naturale Rett.
60x120 - 23^{5/8}"x47^{1/4}"
EHC0 Blu Ande ● T31
EHAZ Thassos ● T31

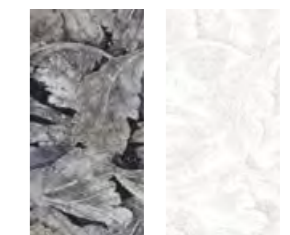

Full Lappato Rett.
30x60 - 11^{13/16}"x23^{5/8}"
EHAJ Thassos ● T42
EHA8 Blu Ande ● T42

Naturale Rett.
30x60 - 11^{13/16}"x23^{5/8}"
EHC4 Thassos ● T14
EHC5 Blu Ande ● T14

Verificare l'abbinamento dei toni tra i formati differenti. - Check the colour matching between different sizes.
Vérifier l'assortiment des tonalités entre les différents formats. - Die Kombination der Farbtöne unter den verschiedenen Formaten prüfen.
Comprobar la combinación de los tonos entre los distintos formatos. - Проверьте сочетание тонов у разных форматов.

TELE DI MARMO REVOLUTION

COLORI E FORMATI

Colours and Sizes | Couleurs et Formats | Farben und Formate | Colores y Tamaños | Цвета и Форматы

Verde Saint Denis

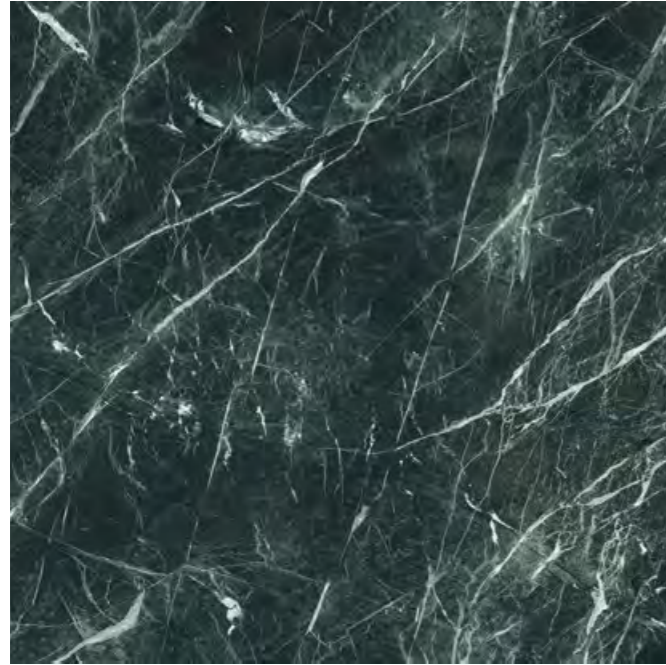

Verde Saint Denis Acanto



Calacatta Black

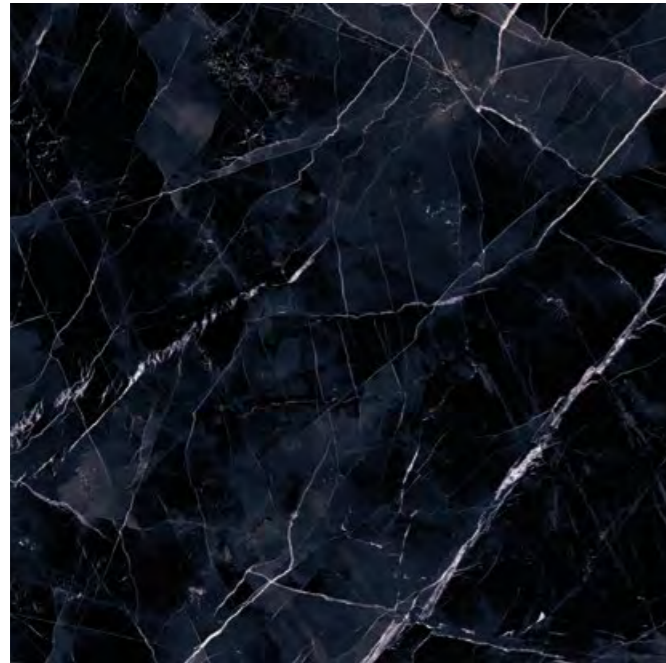

Calacatta Black Acanto

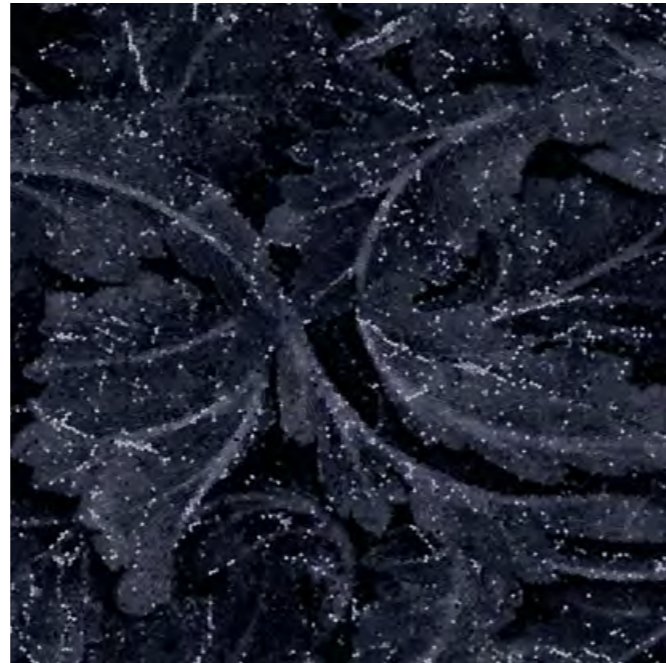

Si consiglia la posa con fuga 2 mm. - Laying with a 2 mm-joint is recommended. - Pose recommandée avec joints de 2 mm.
Es wird eine Fugenbreite von 2 mm empfohlen. - Se recomienda la colocación con juntas de 2 mm. - Рекомендуется укладка с швом 2 мм.

TELE DI MARMO REVOLUTION

COLORI E FORMATI

Colours and Sizes | Couleurs et Formats | Farben und Formate | Colores y Tamaños | Цвета и Форматы

6,5 mm.



Full Lappato Rett.

120x278 - 47^{1/4}"x109^{7/16}"

EHA4 Verde St. Denis ● T116

EHA5 Calacatta Black ● T116

Acanto Full Lappato Rett.

120x278 - 47^{1/4}"x109^{7/16}"

EHAR Verde Saint Denis ● T116

EHAS Calacatta Black ● T116

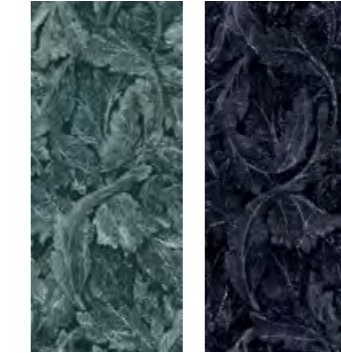

10,5 mm.



Full Lappato Rett.

90x180 - 35^{7/16}"x70^{7/8}"

EJYN Calacatta Black ● T93

9,5 mm.



Full Lappato Rett.

90x90 - 35^{7/16}"x35^{7/16}"

EHA4 Verde Saint Denis ● T77

EHA5 Calacatta Black ● T77

Acanto Full Lappato Rett.

60x120 - 23^{5/8}"x47^{1/4}"

EHAW Verde Saint Denis ● T74

EHAX Calacatta Black ● T74

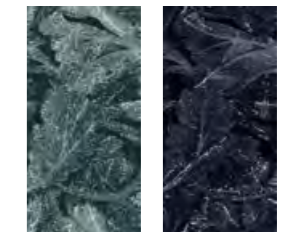

Full Lappato Rett.

60x120 - 23^{5/8}"x47^{1/4}"

EHA9 Verde Saint Denis ● T74

EHA8 Calacatta Black ● T74

Naturale Rett.

60x120 - 23^{5/8}"x47^{1/4}"

EHC1 Verde Saint Denis ● T31

EHC2 Calacatta Black ● T31

Full Lappato Rett.

30x60 - 11^{13/16}"x23^{5/8}"

EHAL Verde Saint Denis ● T42

EHAM Calacatta Black ● T42

Naturale Rett.

30x60 - 11^{13/16}"x23^{5/8}"

EHC6 Verde Saint Denis ● T14

EHC7 Calacatta Black ● T14

Verificare l'abbinamento dei toni tra i formati differenti. - Check the colour matching between different sizes.
Vérifier l'assortiment des tonalités entre les différents formats. - Die Kombination der Farbtöne unter den verschiedenen Formaten prüfen.
Comprobar la combinación de los tonos entre los distintos formatos. - Проверьте сочетание тонов у разных форматов.

TELE DI MARMO REVOLUTION

DECORI

Decors | Decors | Dekore | Decorados | Декоры

INTRECCI*



30x30 - 11^{13/16}"x11^{13/16}"
EHPH
 Blu Ande Nat. ● **A100**
EHPN
 Blu Ande Full Lapp. ● **A102**



30x30 - 11^{13/16}"x11^{13/16}"
EHPG
 Thassos Nat. ● **A100**
EHPM
 Thassos Full Lapp. ● **A102**

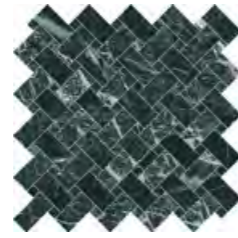

30x30 - 11^{13/16}"x11^{13/16}"
EHPJ Verde
 Saint Denis Nat. ● **A100**
EHPV Verde
 Saint Denis Full Lapp. ● **A102**

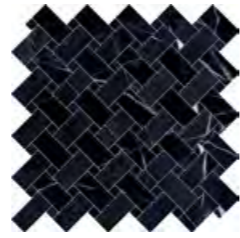

30x30 - 11^{13/16}"x11^{13/16}"
EHPK Calacatta
 Black Nat. ● **A100**
EHPQ Calacatta
 Black Full Lapp. ● **A102**

MOSAICO 3X3*

Tessera - Chip 2,8x2,8 - 1^{7/8}"x1^{7/8}"



30x30 - 11^{13/16}"x11^{13/16}"
EHP6
 Blu Ande Nat. ● **A96**
EHPC
 Blu Ande Full Lapp. ● **A100**



30x30 - 11^{13/16}"x11^{13/16}"
EHP5
 Thassos Nat. ● **A96**
EHPA
 Thassos Full Lapp. ● **A100**

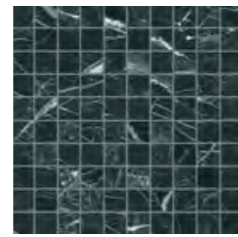

30x30 - 11^{13/16}"x11^{13/16}"
EHP7 Verde
 Saint Denis Nat. ● **A96**
EHPD Verde
 Saint Denis Full Lapp. ● **A100**

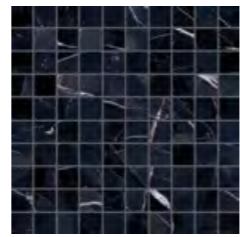

30x30 - 11^{13/16}"x11^{13/16}"
EHP8 Calacatta
 Black Nat. ● **A96**
EHPE Calacatta
 Black Full Lapp. ● **A100**

MOSAICO 5X5*

Tessera - Chip 4,8x4,8 - 1^{7/8}"x1^{7/8}"

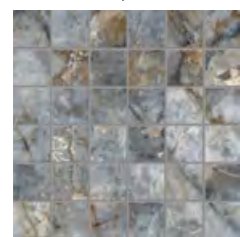

30x30 - 11^{13/16}"x11^{13/16}"
EHNW
 Blu Ande Nat. ● **A86**
EHP1
 Blu Ande Full Lapp. ● **A90**



30x30 - 11^{13/16}"x11^{13/16}"
EHNV
 Thassos Nat. ● **A86**
EHP0
 Thassos Full Lapp. ● **A90**

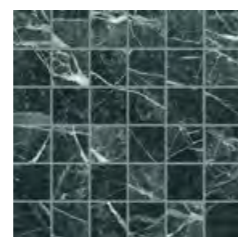

30x30 - 11^{13/16}"x11^{13/16}"
EHNX Verde
 Saint Denis Nat. ● **A86**
EHP2 Verde
 Saint Denis Full Lapp. ● **A90**

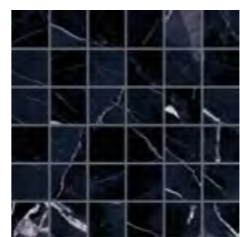







30x30 - 11^{13/16}"x11^{13/16}"
EHNH Calacatta
 Black Nat. ● **A86**
EHP3 Calacatta
 Black Full Lapp. ● **A90**

* Su rete in fibra - On fibre mesh backing - Sur filet en fibre de verre - Auf Glasfasernetz - Sobre malla de fibra - На волоконной сетке

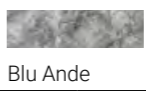
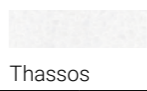
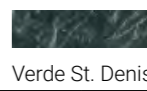
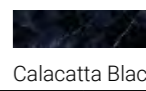
TELE DI MARMO REVOLUTION

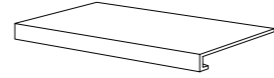
PEZZI SPECIALI

Trims | Pieces Speciales | Formteile | Piezas Especiales | Специальные Изделия



	Dimensione Size	 Blu Ande	 Thassos	 Verde St. Denis	 Calacatta Black	Fascia di prezzo Price band				
	Nat. Rett. 7x60 - 2 ^{3/4} "x23 ^{5/8} " Pcs. Box 15 - LM x Box 9,00	EHPT	EHPS	EHPV	EHPW	● A11				
	Full Lapp. Rett. 7x60 - 2 ^{3/4} "x23 ^{5/8} " Pcs. Box 15 - LM x Box 9,00	EHPZ	EHPY	EHQ0	EHQ1	● A15				
	Full Lapp. Rett. 4,6x90 - 1 ^{13/16} "x35 ^{7/16} " Pcs. Box 8 - LM x Box 7,20	EHQ4	EHQ3	EHQ5	EHQ6	● A20				
	Nat. Rett. 33x120x3,2x3,2 12 ^{15/16} "x47 ^{1/4} "x1 ^{1/4} "x1 ^{1/4} " Pcs. Box 2 - LM x Box 2,40	EHQA	EHQ9	EHQC	EHQD	● A98				
	Full Lapp. Rett. 33x120x3,2x3,2 12 ^{15/16} "x47 ^{1/4} "x1 ^{1/4} "x1 ^{1/4} " Pcs. Box 2 - LM x Box 2,40	EHQG	EHQF	EHQH	EHQJ	● A101				
	Nat. Rett. 33x120x3,2x3,2 12 ^{15/16} "x47 ^{1/4} "x1 ^{1/4} "x1 ^{1/4} " Pcs. Box 1 - LM x Box 1,20	DX EHQM	SX EHQS	DX EHQL	SX EHQR	DX EHQN	SX EHQT	DX EHQP	SX EHQU	● A104
	Full Lapp. Rett. 33x120x3,2x3,2 12 ^{15/16} "x47 ^{1/4} "x1 ^{1/4} "x1 ^{1/4} " Pcs. Box 1 - LM x Box 1,20	DX EHQX	SX EHR2	DX EHQW	SX EHR1	DX EHQY	SX EHR3	DX EHQZ	SX EHR4	● A106
	Nat. Rett. 15x15 - 5 ^{7/8} "x5 ^{7/8} " Pcs. Box 16	EHR7	EHR6	EHR8	EHR9	● A11				
	Nat. Rett. 15x15 - 5 ^{7/8} "x5 ^{7/8} " Pcs. Box 4	EHRD	EHRC	EHRE	EHRF	● A19				

IMBALLI E PESI

Packing and Weight | Emballages et Poids | Verpackung und Gewicht | Embalajes y Pesos | Упаковка и Вес

Formato Size Format Format Tamaño Формат cm	Spessore Thickness Epaisseur Stärke Espesor Толщина mm	Pz. x Mq. Pieces x Sqm Pcs / M ² Stk. x Qm Pzs x Mc. Шт x Кв.М.	Pz. x Scat. Pieces x Box Pcs / Bte Stk. x Krt. Pzs x Caja Шт x Кор.	Mq. x Scat. Sqm x Box M ² / Bte Qm x Krt. Кв.М. x Кор.	Peso x Scat. Weight x Box Poids / Bte Gewicht x Krt. Peso x Caja Вес x Кор. Kg	Scat. x Pal. Boxes x Pal. Bte / Pal. Krt. x Pal. Cajas x Pal. Кор. x Подд.	Mq. x Pal. Sqm x Pal. M ² / Pal. Qm x Pal. Кв.М x Подд.	Peso x Pal. Weight x Pal. Poids / Pal. Gewicht x Pal. Peso x Pal. Вес x Подд. Kg
120x278 Full Lappato	6,5	0,30	1	3,34	50,04		vedi sotto - see below	
90x180 Full Lappato	10,5	0,62	2	3,24	77,76	18	58,32	1400
90x90 Full Lappato	9,5	1,23	2	1,62	35,64	24	38,88	855
60x120 Nat. - Full Lappato	9,5	1,39	2	1,44	31,68	36	51,84	1140
30x60 Nat. - Full Lappato	9,5	5,56	6	1,08	23,76	48	51,84	1140
30x30 Mosaico 5X5 Nat. - Full Lappato	9,5	11,11	5	0,45	8,73	60	27,00	524
30x30 Mosaico 3X3 Nat. - Full Lappato	9,5	11,11	5	0,45	8,73	60	27,00	524
30x30 Intrecci Nat. - Full Lappato	9,5	11,11	5	0,45	8,73	60	27,00	524

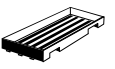
Slabs 120x278

Articolo Item Reference Artikel Articulo Артикула	Dimensione (cm) Size (cm) Format (cm) Tamaño (cm) Формат (cm)	Nr. Lastre No. of Slabs Nbre Dalles Anz. Platten Nº de Placas Кол. Плит	Mq. x Imballo sqm per Pack M ² / Emballage qm pro Verpackung M ² por embalaje Кв.м. x упаковку	Peso Imballo (Kg) Weight of Packaging (kg) Poids Emballage (kg) Gewicht Verpackung (kg) Peso embalaje (kg) Вес упаковки (кг)	Peso Imballo+Lastre (Kg) Weight of Packaging + Slabs (kg) Poids Emballage+Dalles (kg) Gewicht Verpackung+Platten (kg) Peso embalaje + placas (kg) Вес упаковки + плит (кг)
 120x278	136,5x291,5x41,5h	18	60,05	120	1081
 120x278	75x290x160h	40	133,44	180	2315

TELE DI *Marmi* SELECTION



PRODUCT CERTIFIED FOR LOW CHEMICAL EMISSIONS: ULCCM/CG UL 2818

FORMATI

Sizes | Formats | Formate | Tamaños | Форматы

6,5 mm.

120x278 - 47^{1/4}"x109^{7/16}" Full Lappato

10,5 mm.

90x180 - 35^{7/16}"x70^{7/8}" Full Lappato

9,5 mm.

90x90 - 35^{7/16}"x35^{7/16}" Full Lappato

60x120 - 23^{5/8}"x47^{1/4}" Naturale - Full Lappato

30x60 - 11^{13/16}"x23^{5/8}" Naturale - Full Lappato

SUPERFICI

Finishes | Finitions | Oberflächen
Superficies | Отделка поверхности

■ NATURALE

R9 DIN 51130

- DIN 51097

Wet \geq 0,42 DCOF

\geq 0,40 B.C.R.A.

- Pendolo AS 4586

- Pendolo BS 7976

- Pendolo UNE 41901

■ FULL LAPPATO

- DIN 51130

- DIN 51097

- DCOF

- B.C.R.A.

- Pendolo AS 4586

- Pendolo BS 7976

- Pendolo UNE 41901

SHADE VARIATIONS



V3 HIGH

DESTINAZIONI D'USO

Intended uses | Domaines d'application
Zweckbestimmung | Usos previstos | Назначение



放射性水平A类



WHITE PARADISE



ARABESCATO CORCHIA



NERO MARQUINIA

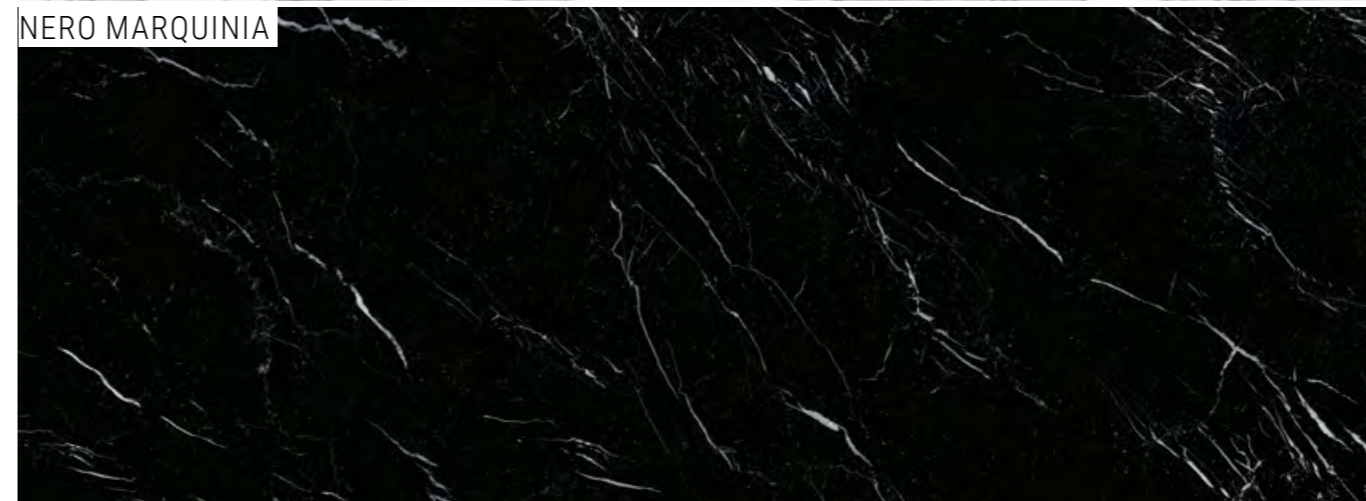

TARSIA



TELE DI MARMO SELECTION

COLORI E FORMATI

Colours and Sizes | Couleurs et Formats | Farben und Formate | Colores y Tamaños | Цвета и Форматы

White Paradise



Arabescato Corchia



Nero Marquinia

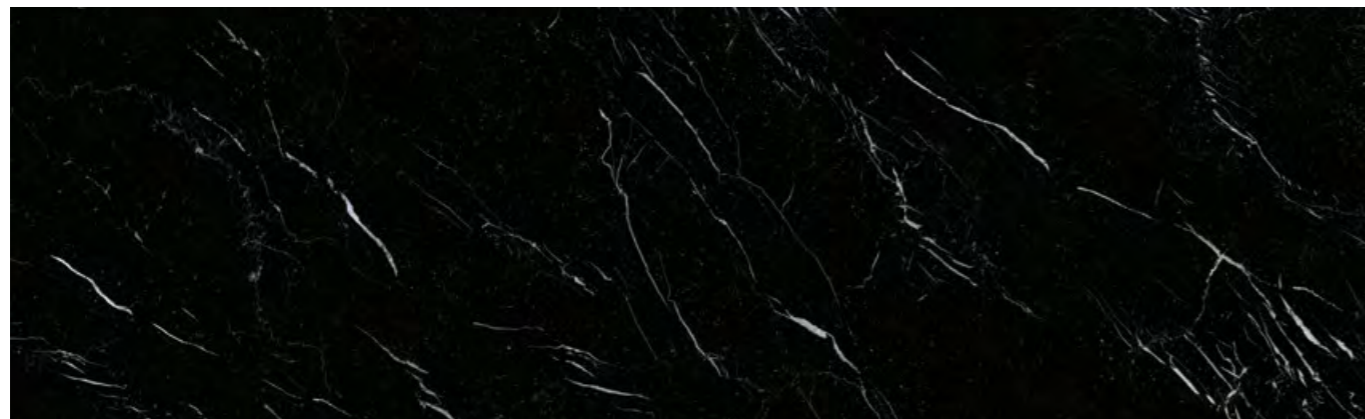

Si consiglia la posa con fuga 2 mm. - Laying with a 2 mm-joint is recommended. - Pose recommandée avec joints de 2 mm.
Es wird eine Fugenbreite von 2 mm empfohlen. - Se recomienda la colocación con juntas de 2 mm. - Рекомендуется укладка с швом 2 мм.

TELE DI MARMO SELECTION

COLORI E FORMATI

Colours and Sizes | Couleurs et Formats | Farben und Formate | Colores y Tamaños | Цвета и Форматы

6,5 mm.



Full Lappato Rett.

120x278 - 47^{1/4}"x109^{7/16}"

EJW0 White Paradise ● T116

EJW1 Arabescato Corchia ● T116

EJW2 Nero Marquinia ● T116

10,5 mm.



Full Lappato Rett.

90x180 - 35^{7/16}"x70^{7/8}"

EJVV White Paradise ● T93

9,5 mm.

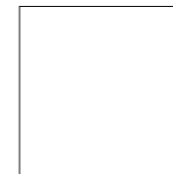

Full Lappato Rett.

90x90 - 35^{7/16}"x35^{7/16}"

EJW8 White Paradise ● T77

EJW9 Arabescato Corchia ● T77

EJWA Nero Marquinia ● T77

Full Lappato Rett.

60x120 - 23^{5/8}"x47^{1/4}"

EJW4 White Paradise ● T74

EJW5 Arabescato Corchia ● T74

EJW6 Nero Marquinia ● T74

Naturale Rett.

60x120 - 23^{5/8}"x47^{1/4}"

EJVQ White Paradise ● T31

EJVR Arabescato Corchia ● T31

EJVS Nero Marquinia ● T31

Full Lappato Rett.

30x60 - 11^{13/16}"x23^{5/8}"

EJWD White Paradise ● T42

EJWE Arabescato Corchia ● T42

EJWF Nero Marquinia ● T42

Naturale Rett.

30x60 - 11^{13/16}"x23^{5/8}"

EJVV White Paradise ● T14

EJVV Arabescato Corchia ● T14

EJVV Nero Marquinia ● T14

Verificare l'abbinamento dei toni tra i formati differenti. - Check the colour matching between different sizes.
Vérifier l'assortiment des tonalités entre les différents formats. - Die Kombination der Farbtöne unter den verschiedenen Formaten prüfen.
Comprobar la combinación de los tonos entre los distintos formatos. - Проверьте сочетание тонов у разных форматов.

TELE DI MARMO SELECTION

DECORI

Decors | Decors | Dekore | Decorados | Декоры

Tarsia  6,5 mm.



DECORI

Decors | Decors | Dekore | Decorados | Декоры



Full Lappato Rett.
120x278 - 47^{1/4} x 109^{7/16}
EJWH Tarsia

● T116

Si consiglia la posa con fuga 2 mm. - Laying with a 2 mm-joint is recommended. - Pose recommandée avec joints de 2 mm.
Es wird eine Fugenbreite von 2 mm empfohlen. - Se recomienda la colocación con juntas de 2 mm. - Рекомендуется укладка с швом 2 мм.

TELE DI MARMO SELECTION

DECORI

Decors | Decors | Dekore | Decorados | Декоры

TARSIA  9,5 mm.

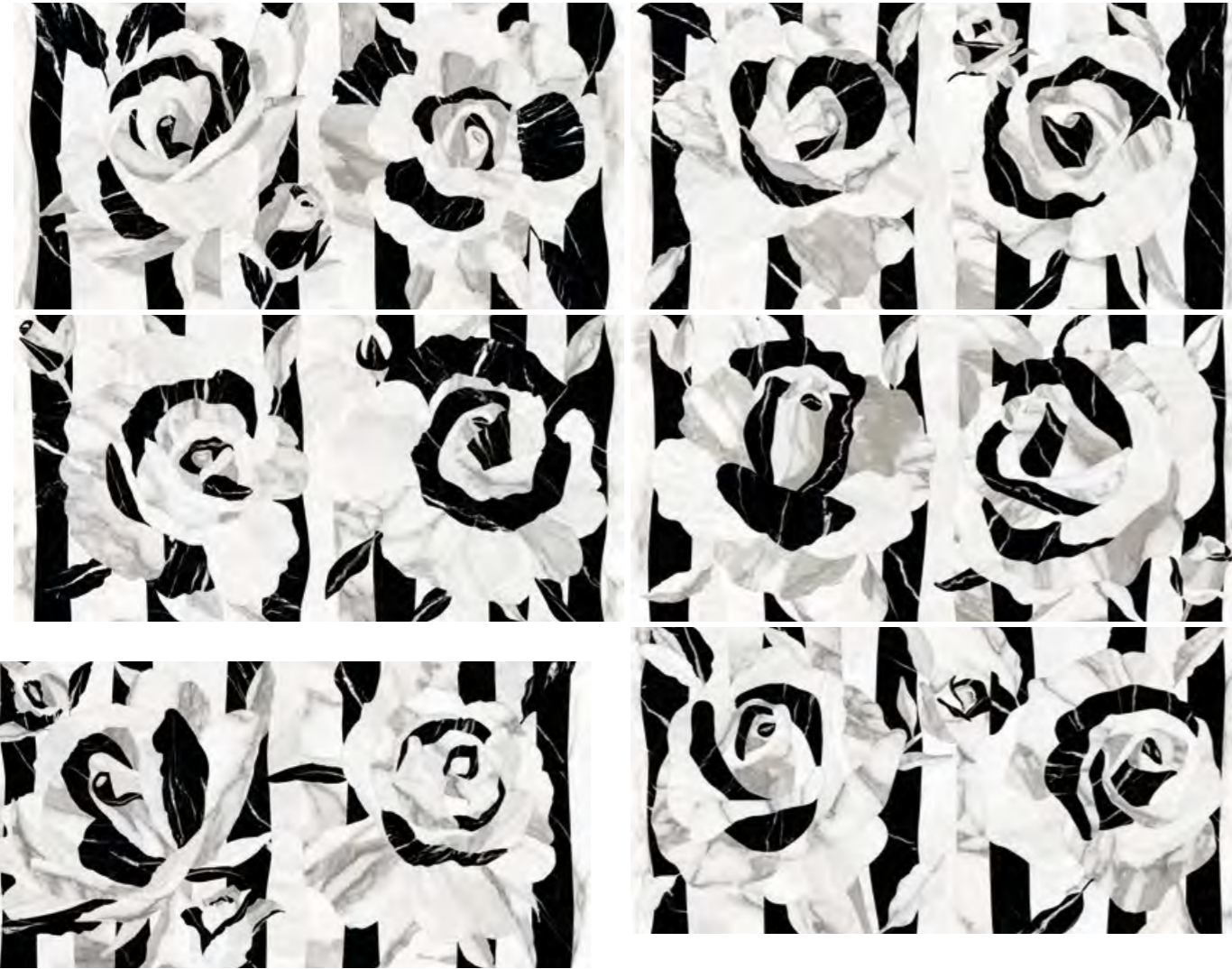

60x120 - 23⁵/₈"x47¹/₄"
EJWK Tarsia Full Lapp.
(6 sogg.)

● T74

TELE DI MARMO SELECTION

DECORI

Decors | Decors | Dekore | Decorados | Декоры

INTRECCI*



30x30 - 11¹³/₁₆"x11¹³/₁₆"
EK50 White Paradise Nat. ● A100
EK54 White Paradise Full Lapp. ● A102



30x30 - 11¹³/₁₆"x11¹³/₁₆"
EK51 Arabes. Corchia Nat. ● A100
EK55 Arabes. Corchia Full Lapp. ● A102



30x30 - 11¹³/₁₆"x11¹³/₁₆"
EK52 Nero Marquinia Nat. ● A100
EK56 Nero Marquinia Full Lapp. ● A102

MOSAICO 3X3*

Tessera - Chip 2,8x2,8 - 1¹/₈"x1¹/₈"

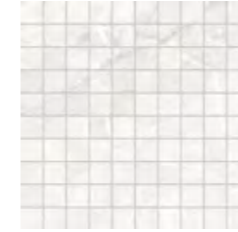

30x30 - 11¹³/₁₆"x11¹³/₁₆"
EK4S White Paradise Nat. ● A96
EK4W White Paradise Full Lapp. ● A100

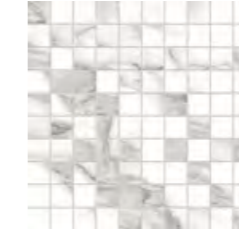

30x30 - 11¹³/₁₆"x11¹³/₁₆"
EK4T Arabes. Corchia Nat. ● A96
EK4X Arabes. Corchia Full Lapp. ● A100

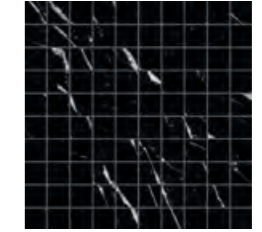

30x30 - 11¹³/₁₆"x11¹³/₁₆"
EK4U Nero Marquinia Nat. ● A96
EK4Y Nero Marquinia Full Lapp. ● A100

MOSAICO 5X5*

Tessera - Chip 4,8x4,8 - 1⁷/₈"x1⁷/₈"



30x30 - 11¹³/₁₆"x11¹³/₁₆"
EK4J White Paradise Nat. ● A86
EK4N White Paradise Full Lapp. ● A90



30x30 - 11¹³/₁₆"x11¹³/₁₆"
EK4K Arabes. Corchia Nat. ● A86
EK4P Arabes. Corchia Full Lapp. ● A90

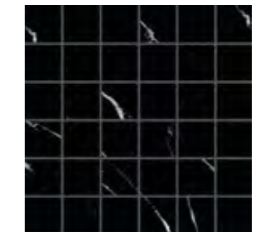

30x30 - 11¹³/₁₆"x11¹³/₁₆"
EK4L Nero Marquinia Nat. ● A86
EK4Q Nero Marquinia Full Lapp. ● A90

* Su rete in fibra - On fibre mesh backing - Sur filet en fibre de verre - Auf Glasfasernetz - Sobre malla de fibra - На волоконной сетке

TELE DI MARMO SELECTION

PEZZI SPECIALI

Trims | Pieces Speciales | Formteile | Piezas Especiales | Специальные Изделия

	Dimensione Size				Fascia di prezzo Price band			
	Nat. Rett. 7x60 - 2 ^{3/4} "x23 ^{5/8} " Pcs. Box 15 - LM x Box 9,00	EK58	EK59	EK5A	● A11			
	Full Lapp. Rett. 7x60 - 2 ^{3/4} "x23 ^{5/8} " Pcs. Box 15 - LM x Box 9,00	EK5D	EK5E	EK5F	● A15			
	Full Lapp. Rett. 4,6x90 - 1 ^{13/16} "x35 ^{7/16} " Pcs. Box 8 - LM x Box 7,20	EK5H	EK5J	EK5K	● A20			
	Nat. Rett. 33x120x3,2x3,2 12 ^{15/16} "x47 ^{1/4} "x1 ^{1/4} "x1 ^{1/4} " Pcs. Box 2 - LM x Box 2,40	EK5M	EK5N	EK5P	● A98			
	Full Lapp. Rett. 33x120x3,2x3,2 12 ^{15/16} "x47 ^{1/4} "x1 ^{1/4} "x1 ^{1/4} " Pcs. Box 2 - LM x Box 2,40	EK5R	EK5S	EK5T	● A101			
	Nat. Rett. 33x120x3,2x3,2 12 ^{15/16} "x47 ^{1/4} "x1 ^{1/4} "x1 ^{1/4} " Pcs. Box 1 - LM x Box 1,20	DX EK5V	SX EK5Z	DX EK5W	SX EK60	DX EK5X	SX EK61	● A104
	Full Lapp. Rett. 33x120x3,2x3,2 12 ^{15/16} "x47 ^{1/4} "x1 ^{1/4} "x1 ^{1/4} " Pcs. Box 1 - LM x Box 1,20	DX EK63	SX EK67	DX EK64	SX EK68	DX EK65	SX EK69	● A106

IMBALLI E PESI

Packing and Weight | Emballages et Poids | Verpackung und Gewicht | Embalajes y Pesos | Упаковка и Вес

Formato Size Format Format Tamaño Формат cm	Spessore Thickness Epaisseur Stärke Espesor Толщина mm	Pz. x Mq. Pieces x Sqm Pcs / M ² Stk. x Qm Pzs x Mc. Шт x Кв.М.	Pz. x Scat. Pieces x Box Pcs / Bte Stk. x Krt. Pzs x Caja Шт x Кор.	Mq. x Scat. Sqm x Box M ² / Bte Qm x Krt. Mc. x Caja Кв.М. x Кор.	Peso x Scat. Weight x Box Poids / Bte Gewicht x Krt. Peso x Caja Вес x Кор. Kg	Scat. x Pal. Boxes x Pal. Bte / Pal. Krt. x Pal. Cajas x Pal. Кор. x Подд.	Mq. x Pal. Sqm x Pal. M ² / Pal. Qm x Pal. Mc. x Pal. Кв.М x Подд.	Peso x Pal. Weight x Pal. Poids / Pal. Gewicht x Pal. Peso x Pal. Вес x Подд. Kg
120x278 Full Lappato	6,5	0,30	1	3,34	50,04		vedi sotto - see below	
90x180 Full Lappato	10,5	0,62	2	3,24	77,76	18	58,32	1400
90x90 Full Lappato	9,5	1,23	2	1,62	35,64	24	38,88	855
60x120 Nat. - Full Lappato	9,5	1,39	2	1,44	31,68	36	51,84	1140
30x60 Nat. - Full Lappato	9,5	5,56	6	1,08	23,76	48	51,84	1140
30x30 Mosaico 5X5 Nat. - Full Lappato	9,5	11,11	5	0,45	8,73	60	27,00	524
30x30 Mosaico 3X3 Nat. - Full Lappato	9,5	11,11	5	0,45	8,73	60	27,00	524
30x30 Intrecci Nat. - Full Lappato	9,5	11,11	5	0,45	8,73	60	27,00	524

Slabs 120x278

Articolo Item Reference Artikel Articulo Артикула	Dimensione (cm) Size (cm) Format (cm) Format (cm) Tamaño (cm) Формат (cm)	Nr. Lastre No. of Slabs Nbre Dalles Anz. Platten Nº de Placas Кол. Плит	Mq. x Imballo sqm per Pack M ² / Emballage qm pro Verpackung M ² por embalaje Кв.м. x упаковку	Peso Imballo (Kg) Weight of Packaging (kg) Poids Emballage (kg) Gewicht Verpackung (kg) Peso embalaje (kg) Вес упаковки (кг)	Peso Imballo+Lastre (Kg) Weight of Packaging + Slabs (kg) Poids Emballage+Dalles (kg) Gewicht Verpackung+Platten (kg) Peso embalaje + placas (kg) Вес упаковки + плит (кг)
 120x278	136,5x291,5x41,5h	18	60,05	120	1081
 120x278	75x290x160h	40	133,44	180	2315

TELE DI MARMO SELECTION



TOTALOOK



PRODUCT CERTIFIED FOR LOW CHEMICAL EMISSIONS: ULCDM/CG UL 2818

FORMATI

Sizes | Formats | Formate | Tamaños | Форматы

6,5 mm. 120x120 - 47^{1/4}"x47^{1/4}" Nat.
60x120 - 23^{5/8}"x47^{1/4}" Nat.

9,5 mm. 80x80 - 31^{1/2}"x31^{1/2}" Soft - Tecn.
40x80 - 15^{3/4}"x31^{1/2}" Soft
60x60 - 23^{5/8}"x23^{5/8}" Soft
30x60 - 11^{13/16}"x23^{5/8}" Soft
6x24 - 2^{3/8}"x9^{7/16}" Majolica

20MM 80x80 - 31^{1/2}"x31^{1/2}" Nat.
60x60 - 23^{5/8}"x23^{5/8}" Nat.

SUPERFICI

Finishes | Finitions | Oberflächen
Superficies | Отделка поверхности

SOFT | MAJOLICA MATT

R9 DIN 51130

- DIN 51097

Wet \geq 0,42 DCOF

\geq 0,40 B.C.R.A.

- Pendolo AS 4586

- Pendolo BS 7976

- Pendolo UNE 41901

NATURALE

R10 DIN 51130

B (A+B) DIN 51097

Wet \geq 0,50 DCOF

\geq 0,40 B.C.R.A.

P2 Pendolo AS 4586

< 36 Moderate Slip potential Pendolo BS 7976

- Pendolo UNE 41901

TECNICA | 20MM

R11 DIN 51130

C (A+B+C) DIN 51097

Wet \geq 0,65 DCOF

\geq 0,40 B.C.R.A.

P4 Pendolo AS 4586

> 36 Low Slip potential Pendolo BS 7976

3 Pendolo UNE 41901

SHADE VARIATIONS



V3 HIGH

DESTINAZIONI D'USO

Intended uses | Domaines d'application
Zweckbestimmung | Usos previstos | Назначение

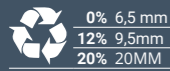

TECNICA

Premium Technical Feature

Nella versione Tecnica la superficie è particolarmente antiscivolo, tanto da renderla perfetta per spazi esterni, pubblici e privati.

In the Tecnica version, the surface has outstanding anti-slip properties, making it perfect for public and private outdoor areas.



BLU AVIO



SABBIA

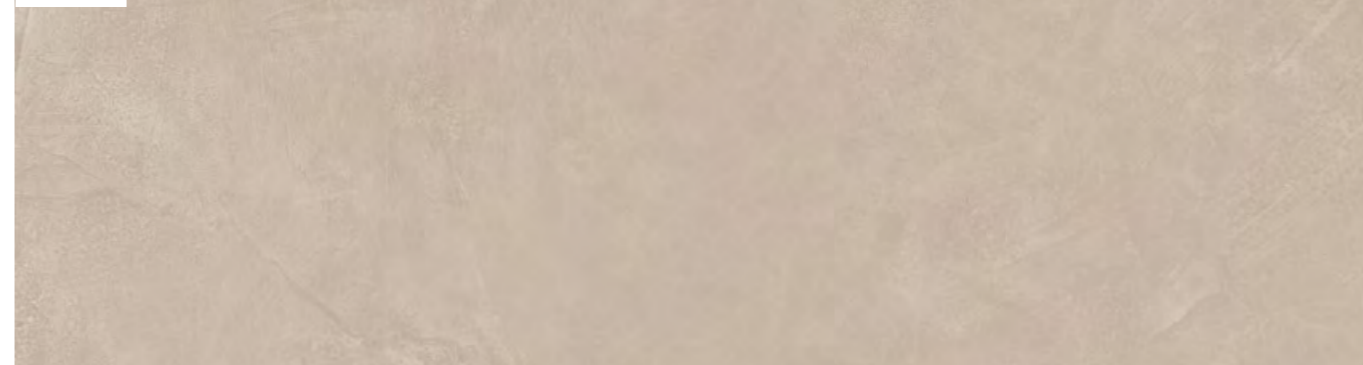

BIANCO



GRIGIO



ANTRACITE



COLORI E FORMATI

Colours and Sizes | Couleurs et Formats | Farben und Formate | Colores y Tamaños | Цвета и Форматы

Blu Avio

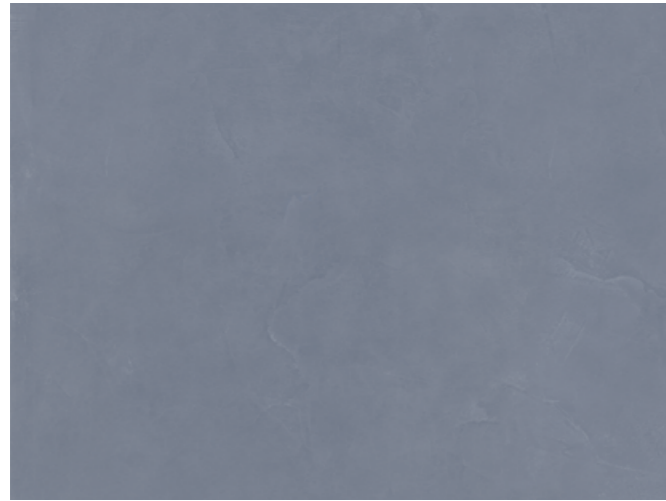

Sabbia



Bianco



Grigio



Antracite

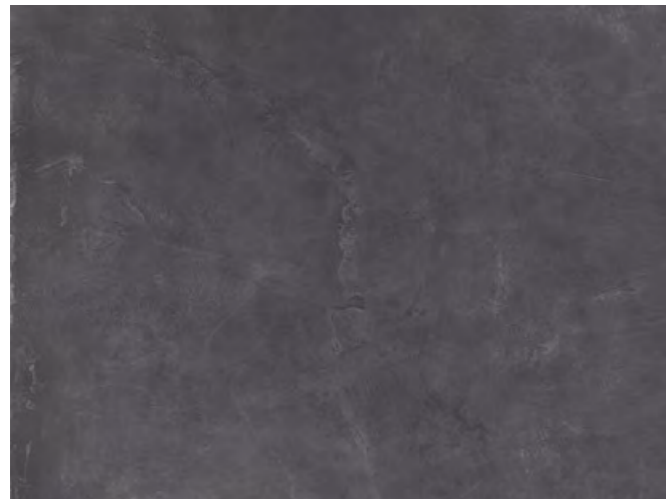

COLORI E FORMATI

Colours and Sizes | Couleurs et Formats | Farben und Formate | Colores y Tamaños | Цвета и Форматы

6,5 mm.

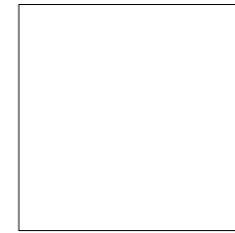

Naturale Rett.
120x120 - 47^{1/4}x47^{1/4}"
EHD4 Blu Avio ● T74
EHD1 Sabbia ● T74
EHD0 Bianco ● T74
EHD2 Grigio ● T74
EHD3 Antracite ● T74



Naturale Rett.
60x120 - 23^{5/8}x47^{1/4}"
EHDA Blu Avio ● T59
EHD7 Sabbia ● T59
EHD6 Bianco ● T59
EHD8 Grigio ● T59
EHD9 Antracite ● T59

9,5 mm.



Soft Rett.
80x80 - 31^{1/2}x31^{1/2}"
EHCE Blu Avio U₄P₃E₃C₂ ● T25
EHCA Sabbia U₄P₃E₃C₂ ● T25
EHC9 Bianco U₄P₃E₃C₂ ● T25
EHCC Grigio U₄P₃E₃C₂ ● T25
EHCD Antracite U₄P₃E₃C₂ ● T25



Soft Rett.
40x80 - 15^{3/4}x31^{1/2}"
EHCL Blu Avio U₄P₄E₃C₂ ● T23
EHCH Sabbia U₄P₄E₃C₂ ● T23
EHCG Bianco U₄P₄E₃C₂ ● T23
EHCJ Grigio U₄P₄E₃C₂ ● T23
EHCK Antracite U₄P₄E₃C₂ ● T23



Soft Rett.
60x60 - 23^{5/8}x23^{5/8}"
EHCS Blu Avio U₄P₄E₃C₂ ● T17
EHCP Sabbia U₄P₄E₃C₂ ● T17
EHCN Bianco U₄P₄E₃C₂ ● T17
EHCQ Grigio U₄P₄E₃C₂ ● T17
EHCR Antracite U₄P₄E₃C₂ ● T17



Soft Rett.
30x60 - 11^{13/16}x23^{5/8}"
EHCY Blu Avio U₄P₄E₃C₂ ● T14
EHCV Sabbia U₄P₄E₃C₂ ● T14
EHCU Bianco U₄P₄E₃C₂ ● T14
EHCW Grigio U₄P₄E₃C₂ ● T14
EHCX Antracite U₄P₄E₃C₂ ● T14

Tecnica Rett.
80x80 - 31^{1/2}x31^{1/2}"
EHF3 Blu Avio ● T25
EHF0 Sabbia ● T25
EHEZ Bianco ● T25
EHF1 Grigio ● T25
EHF2 Antracite ● T25

20MM

Naturale Rett.
80x80 - 31^{1/2}x31^{1/2}"
EHFA Grigio ● T67
EHFC Antracite ● T67

Naturale Rett.
60x60 - 23^{5/8}x23^{5/8}"
EHV6 Grigio ● T34

Si consiglia la posa con fuga 2 mm. - Laying with a 2 mm-joint is recommended. - Pose recommandée avec joints de 2 mm.
Es wird eine Fugenbreite von 2 mm empfohlen. - Se recomienda la colocación con juntas de 2 mm. - Рекомендуется укладка с швом 2 мм.

Verificare l'abbinamento dei toni tra i formati differenti. - Check the colour matching between different sizes.
Vérifier l'assortiment des tonalités entre les différents formats. - Die Kombination der Farbtöne unter den verschiedenen Formaten prüfen.
Comprobar la combinación de los tonos entre los distintos formatos. - Проверьте сочетание тонов у разных форматов.

TOTALOOK

DECORI

Decors | Decors | Dekore | Decorados | Декоры

TOTASLIM

6,5 mm. SAGOMA*



30x30 - 11^{13/16}"x11^{13/16}"
EHWU Sagoma Nat. • A110

6,5 mm. MOSAICO 3X3*

Tessera - Chip 2,8x2,8 - 1^{1/8}"x1^{1/8}"



30x30 - 11^{13/16}"x11^{13/16}"
EHVR Blu Avio Nat. • A100 **EHVN Sabbia Nat. • A100** **EHVM Bianco Nat. • A100** **EHVP Grigio Nat. • A100** **EHVQ Antracite Nat. • A100**

6,5 mm. MOSAICO SEQUENZA*

Tessere 3,13x29,8 - 1^{1/4}"x11^{3/4}"

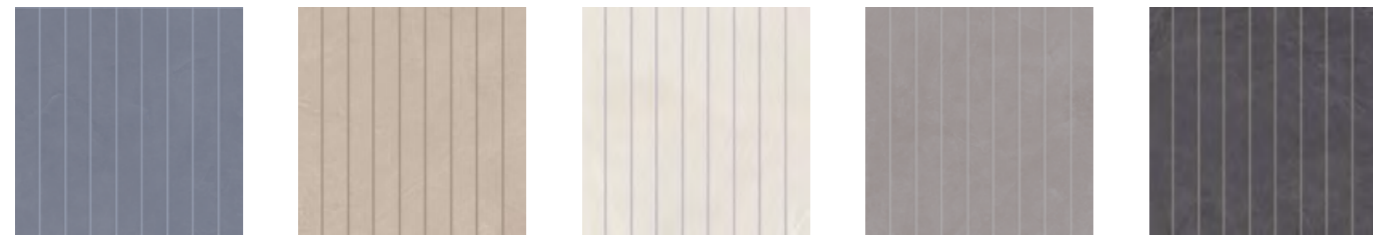

30x30 - 11^{13/16}"x11^{13/16}"
EHXZ Blu Avio Nat. • A102 **EHWQ Sabbia Nat. • A102** **EHWP Bianco Nat. • A102** **EHWR Grigio Nat. • A102** **EHWS Antracite Nat. • A102**

TOTALOOK

DECORI

Decors | Decors | Dekore | Decorados | Декоры

TOTALBRICK

9,5 mm. MAJOLICA MATT



6x24 - 2^{3/8}"x9^{7/16}"
EH98 Blu Avio • T22

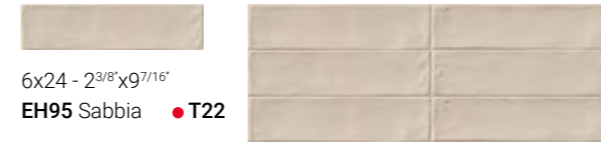

6x24 - 2^{3/8}"x9^{7/16}"
EH95 Sabbia • T22



6x24 - 2^{3/8}"x9^{7/16}"
EH94 Bianco • T22



6x24 - 2^{3/8}"x9^{7/16}"
EH96 Grigio • T22

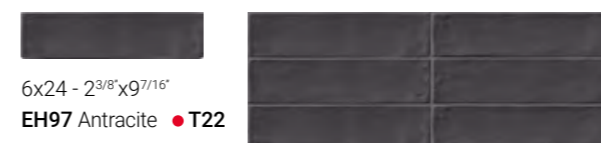

6x24 - 2^{3/8}"x9^{7/16}"
EH97 Antracite • T22

9,5 mm. MAJOLICA LUX



6x24 - 2^{3/8}"x9^{7/16}"
EH6H Blu Avio • T29

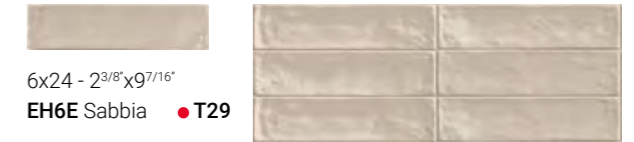

6x24 - 2^{3/8}"x9^{7/16}"
EH6E Sabbia • T29

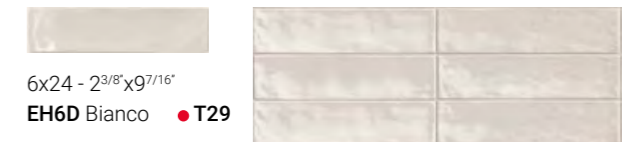

6x24 - 2^{3/8}"x9^{7/16}"
EH6D Bianco • T29



6x24 - 2^{3/8}"x9^{7/16}"
EH6F Grigio • T29



6x24 - 2^{3/8}"x9^{7/16}"
EH6G Antracite • T29

* Su rete in fibra - On fibre mesh backing - Sur filet en fibre de verre - Auf Glasfasernetz - Sobre malla de fibra - На волоконной сетке

TOTALOOK

DECORI

Decors | Decors | Dekore | Decorados | Декоры

9,5 mm. CUBO



20x20 - 7⁷/₈"x7⁷/₈"

EHEJ Cubo Nat. Rett. ● T94



9,5 mm. INCROCI

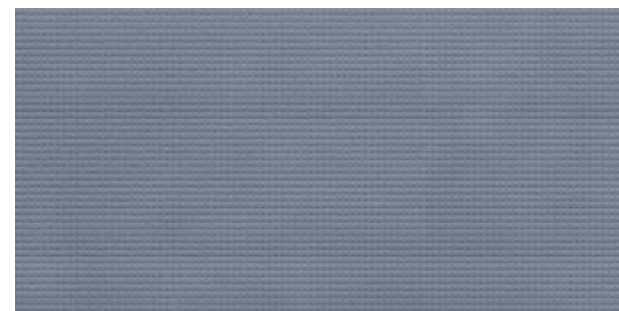

40x80 - 15³/₄"x31¹/₂"

EHJG Blu Avio Nat. Rett. ● T26

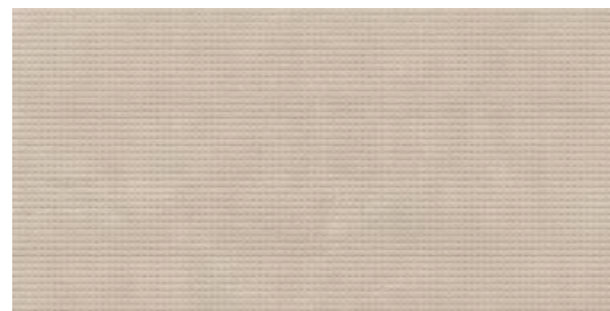

40x80 - 15³/₄"x31¹/₂"

EHJD Sabbia Nat. Rett. ● T26

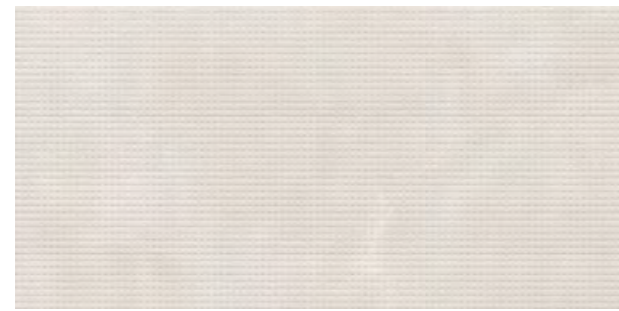

40x80 - 15³/₄"x31¹/₂"

EHJC Bianco Nat. Rett. ● T26

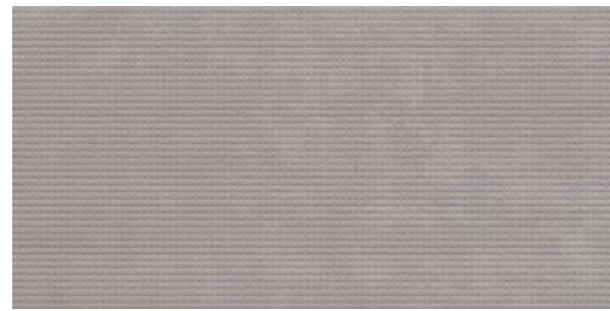

40x80 - 15³/₄"x31¹/₂"

EHJE Grigio Nat. Rett. ● T26



40x80 - 15³/₄"x31¹/₂"

EHJF Antracite Nat. Rett. ● T26

TOTALOOK

DECORI

Decors | Decors | Dekore | Decorados | Декоры

9,5 mm. DOLCELINEA



30x60 - 11¹³/₁₆"x23⁵/₈"

EHJN Blu Avio Nat. Rett. ● T17



30x60 - 11¹³/₁₆"x23⁵/₈"

EHJK Sabbia Nat. Rett. ● T17



30x60 - 11¹³/₁₆"x23⁵/₈"

EHJJ Bianco Nat. Rett. ● T17



30x60 - 11¹³/₁₆"x23⁵/₈"

EHJL Grigio Nat. Rett. ● T17



30x60 - 11¹³/₁₆"x23⁵/₈"

EHJM Antracite Nat. Rett. ● T17

9,5 mm. MOSAICO 3X3*

Tessera - Chip 2,8x2,8 - 1¹/₈"x1¹/₈"

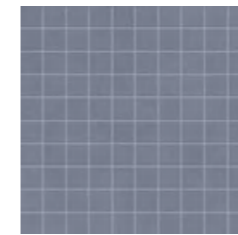

30x30 - 11¹³/₁₆"x11¹³/₁₆"

EHJU Blu Avio Nat. ● A96

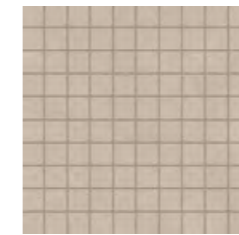

30x30 - 11¹³/₁₆"x11¹³/₁₆"

EHJR Sabbia Nat. ● A96



30x30 - 11¹³/₁₆"x11¹³/₁₆"

EHJQ Bianco Nat. ● A96

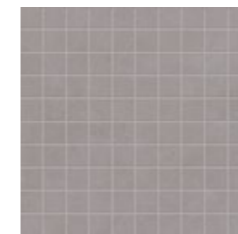

30x30 - 11¹³/₁₆"x11¹³/₁₆"

EHJS Grigio Nat. ● A96

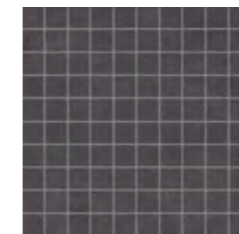







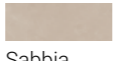
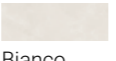

30x30 - 11¹³/₁₆"x11¹³/₁₆"

EHJT Antracite Nat. ● A96

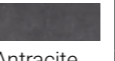
* Su rete in fibra - On fibre mesh backing - Sur filet en fibre de verre
Auf Glasfasernetz - Sobre malla de fibra - На волоконной сетке

PEZZI SPECIALI

Trims | Pieces Speciales | Formteile | Piezas Especiales | Специальные Изделия

	Dimensione Size	 Blu Avio	 Sabbia	 Bianco	 Grigio	 Antracite	Fascia di prezzo Price band
 Battiscopa - Skirting	Nat. Rett. 7x60 - 2 ³ / ₄ "x23 ⁵ / ₈ " Pcs. Box 15 - LM x Box 9,00	EHK0	EHJX	EHJW	EHJY	EHJZ	● A11
	Nat. Rett. 4,6x80 - 1 ¹³ / ₁₆ "x31 ¹ / ₂ " Pcs. Box 12 - LM x Box 9,60	EHK6	EHK3	EHK2	EHK4	EHK5	● A16
 Gradino - Stair Tread	Nat. Rett. 33x60 - 12 ¹⁵ / ₁₆ "x23 ⁵ / ₈ " Pcs. Box 6 - LM x Box 3,60	EHKD	EHK9	EHK8	EHKA	EHKC	● A54
 Gradone - Step	Nat. Rett. 33x60x3,2x3,2 12 ¹⁵ / ₁₆ "x23 ⁵ / ₈ "x1 ¹ / ₄ "x1 ¹ / ₄ " Pcs. Box 4 - LM x Box 2,40	EHKK	EHKG	EHKF	EHKH	EHKJ	● A68
 Angolare Dx Sx Corner Tile Dx Sx	Nat. Rett. 33x60x3,2x3,2 - 12 ¹⁵ / ₁₆ "x23 ⁵ / ₈ "x1 ¹ / ₄ "x1 ¹ / ₄ " Pcs. Box 2 - LM x Box 1,20	DX EHKR	DX EHKN	DX EHKM	DX EHKP	DX EHKQ	● A90
		SX EHKX	SX EHKU	SX EHKT	SX EHKV	SX EHKW	
 Becco Civetta - Bullnose	Matt 6x24 - 2 ³ / ₈ "x9 ⁷ / ₁₆ " Pcs. Box 36	EHVK	EHVG	EHVF	EHVH	EHVJ	● A8
		Lux 6x24 - 2 ³ / ₈ "x9 ⁷ / ₁₆ " Pcs. Box 36	EHVD	EHV9	EHV8	EHVA	EHVC

Pezzi speciali 20mm su richiesta
20mm trims available on request
pièces spéciales 20mm (sur demande)
formteile 20mm auf anfrage erhältlich
piezas especiales 20mm disponibles bajo pedido
Специальные изделия 20мм по запросу

IMBALLI E PESI

Packing and Weight | Emballages et Poids | Verpackung und Gewicht | Embalajes y Pesos | Упаковка и Вес

Formato Size Format Format Татаño Формат cm	Spessore Thickness Epaisseur Stärke Espesor Толщина mm	Pz. x Mq. Pieces x Sqm Pcs / M ² Stk. x Qm Pzs x Mc. Шт x Кв.М.	Pz. x Scat. Pieces x Box Pcs / Bte Stk. x Krt. Pzs x Caja Шт x Кор.	Mq. x Scat. Sqm x Box M ² / Bte Qm x Krt. Mc. x Caja Кв.М. x Кор.	Peso x Scat. Weight x Box Poids / Bte Gewicht x Krt. Peso x Caja Вес x Кор. Kg	Scat. x Pal. Boxes x Pal. Bte / Pal. Krt. x Pal. Cajas x Pal. Кор. x Подд.	Mq. x Pal. Sqm x Pal. M ² / Pal. Qm x Pal. Mc. x Pal. Кв.М x Подд.	Peso x Pal. Weight x Pal. Poids / Pal. Gewicht x Pal. Peso x Pal. Вес x Подд. Kg
120x120 Natural	6,5	0,69	2	2,88	43,20	20	57,60	984
60x120 Natural	9,5	1,39	2	1,44	31,68	36	51,84	1140
80x80 Soft - Tecnica	9,5	1,56	2	1,28	28,16	42	53,76	1183
40x80 Soft - Incroci	9,5	3,13	3	0,96	21,12	28	26,88	591
60x60 Soft	9,5	2,78	3	1,08	23,76	40	43,20	950
30x60 Soft - Dolcelinea	9,5	5,56	6	1,08	23,76	48	51,84	1140
30x30 Mosaico 3X3 Naturale	6,5	11,11	5	0,45	6,75	60	27,00	405
30x30 Mosaico Sequenza Naturale	6,5	11,11	5	0,45	6,75	60	27,00	405
30x30 Mosaico Sagoma Naturale	6,5	11,11	6	0,34	8,10	60	20,40	486
30x30 Mosaico 3X3 Naturale	9,5	11,11	5	0,45	8,73	60	27,00	524
20x20 Cubo Naturale	9,5	25,00	18	0,68	15,84	72	48,96	1140
6x24 Majolica Lux - Matt	9,5	69,44	36	0,52	11,41	95	49,21	1084
80x80 20MM Naturale	20	1,56	1	0,64	29,44	45	28,80	1325
60x60 20MM Naturale	20	2,78	2	0,72	33,12	32	23,04	1060



Sabbia Nat. Rett.
80x80 - 31¹/₂"x31¹/₂"

Sabbia Nat. Rett.
40x80 - 15³/₄"x31¹/₂"

Cubo
20x20 - 7⁷/₈"x7⁷/₈"

TRACCE



PRODUCT CERTIFIED FOR LOW CHEMICAL EMISSIONS:
ULCDM/CG
UL 2818

FORMATI

Sizes | Formats | Formate | Tamaños | Форматы

9,5 mm.

60x60 - 23^{5/8}"x23^{5/8}" Naturale

30x60 - 11^{13/16}"x23^{5/8}" Naturale

SUPERFICI

Finishes | Finitions | Oberflächen
Superficies | Отделка поверхности

NATURALE

R10 DIN 51130

B (A+B) DIN 51097

Wet \geq 0,50 DCOF

\geq 0,40 B.C.R.A.

P2 Pendolo AS 4586

< 36 Moderate Slip potential Pendolo BS 7976

- Pendolo UNE 41901

SHADE VARIATIONS



V4 RANDOM

DESTINAZIONI D'USO

Intended uses | Domaines d'application
Zweckbestimmung | Usos previstos | Назначение



CCC



12%



IVORY



TAUPE



DENIM



GREY



DARK GREY

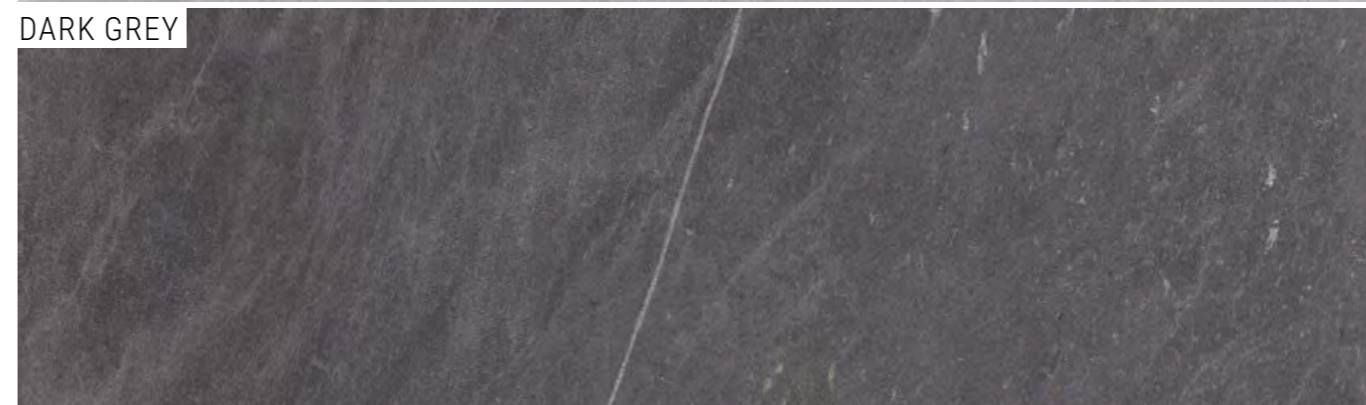

TRACCE

COLORI E FORMATI

Colours and Sizes | Couleurs et Formats | Farben und Formate | Colores y Tamaños | Цвета и Форматы

Ivory



Taupe



Denim



Grey



Dark Grey



TRACCE

COLORI E FORMATI

Colours and Sizes | Couleurs et Formats | Farben und Formate | Colores y Tamaños | Цвета и Форматы

9,5 mm.

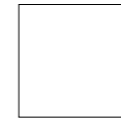

Naturale Rett.

60x60 - 23^{5/8}"x23^{5/8}"

- ECK7 Ivory ● T17
- ECK8 Taupe ● T17
- ECK9 Denim ● T17
- ECKA Grey ● T17
- ECKC Dark Grey ● T17

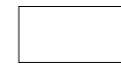

Naturale Rett.

30x60 - 11^{13/16}"x23^{5/8}"

- ECKD Ivory ● T14
- ECKF Taupe ● T14
- ECKH Denim ● T14
- ECKK Grey ● T14
- ECKM Dark Grey ● T14

Si consiglia la posa con fuga 2 mm. - Laying with a 2 mm-joint is recommended. - Pose recommandée avec joints de 2 mm.
Es wird eine Fugenbreite von 2 mm empfohlen. - Se recomienda la colocación con juntas de 2 mm. - Рекомендуется укладка с швом 2 мм.

Verificare l'abbinamento dei toni tra i formati differenti. - Check the colour matching between different sizes.
Vérifier l'assortiment des tonalités entre les différents formats. - Die Kombination der Farbtöne unter den verschiedenen Formaten prüfen.
Comprobar la combinación de los tonos entre los distintos formatos. - Проверьте сочетание тонов у разных форматов.

TRACCE

DECORI

Decors | Decors | Dekore | Decorados | Декоры

DECORO RAIL 3D



30x60 - 11^{13/16}"x23^{5/8}"
ECKE Ivory Nat. Rett. ● T17



15x60 - 5^{7/8}"x23^{5/8}"
ECR2 Ivory Nat. Rett. ● T35



30x60 - 11^{13/16}"x23^{5/8}"
ECKG Taupe Nat. Rett. ● T17



15x60 - 5^{7/8}"x23^{5/8}"
ECR3 Taupe Nat. Rett. ● T35



30x60 - 11^{13/16}"x23^{5/8}"
ECKJ Denim Nat. Rett. ● T17

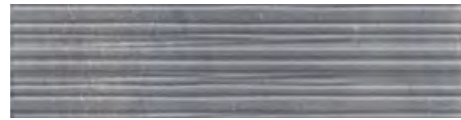

15x60 - 5^{7/8}"x23^{5/8}"
ECR4 Denim Nat. Rett. ● T35



30x60 - 11^{13/16}"x23^{5/8}"
ECKL Grey Nat. Rett. ● T17



15x60 - 5^{7/8}"x23^{5/8}"
ECR5 Grey Nat. Rett. ● T35

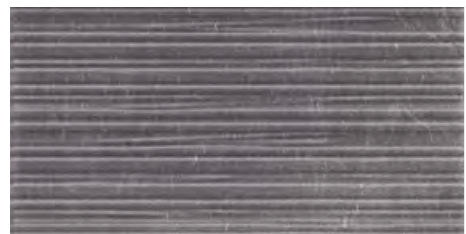

30x60 - 11^{13/16}"x23^{5/8}"
ECKN Dark Grey Nat. Rett. ● T17

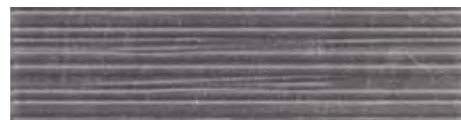

15x60 - 5^{7/8}"x23^{5/8}"
ECR6 Dark Grey Nat. Rett. ● T35

TRACCE

DECORI

Decors | Decors | Dekore | Decorados | Декоры

MOSAICO 5X5*

Tessera - Chip 4,8x4,8 - 1^{7/8}"x1^{7/8}"



30x30 - 11^{13/16}"x11^{13/16}"
ECNJ Ivory Nat. ● A86



30x30 - 11^{13/16}"x11^{13/16}"
ECNK Taupe Nat. ● A86

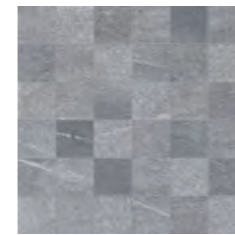

30x30 - 11^{13/16}"x11^{13/16}"
ECNL Denim Nat. ● A86

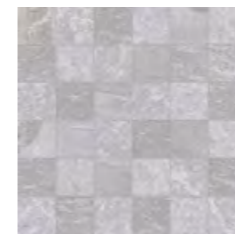

30x30 - 11^{13/16}"x11^{13/16}"
ECNM Grey Nat. ● A86

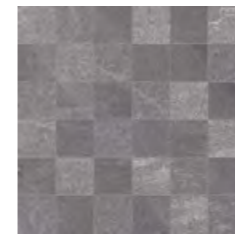

30x30 - 11^{13/16}"x11^{13/16}"
ECNN Dark Grey Nat. ● A86

MOSAICO DOMINO*

Tessera - Chip 2,3x4,8 - 7/8"x1^{7/8}"



30x30 - 11^{13/16}"x11^{13/16}"
ECRL Ivory Nat. ● A100



30x30 - 11^{13/16}"x11^{13/16}"
ECRM Taupe Nat. ● A100



30x30 - 11^{13/16}"x11^{13/16}"
ECRN Denim Nat. ● A100



30x30 - 11^{13/16}"x11^{13/16}"
ECRP Grey Nat. ● A100



30x30 - 11^{13/16}"x11^{13/16}"
ECRQ Dark Grey Nat. ● A100

MOSAICO ARROWS*



Chiusura mezza losanga
2,16x13,6 - 7/8"x5^{3/8}"
ECS0 Ivory Nat. ● A2
Pcs. Box 10

Chiusura triangolo
4,5x2,6 - 1^{3/4}"x1^{1/6}"
ECS5 Ivory Nat. ● A2
Pcs. Box 12

28,5x29,3 - 11^{1/4}"x11^{9/16}"
ECRV Ivory Nat. ● A110



Chiusura mezza losanga
2,16x13,6 - 7/8"x5^{3/8}"
ECS1 Taupe Nat. ● A2
Pcs. Box 10

Chiusura triangolo
4,5x2,6 - 1^{3/4}"x1^{1/6}"
ECS6 Taupe Nat. ● A2
Pcs. Box 12

28,5x29,3 - 11^{1/4}"x11^{9/16}"
ECRW Taupe Nat. ● A110

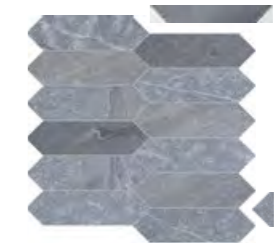

Chiusura mezza losanga
2,16x13,6 - 7/8"x5^{3/8}"
ECS2 Denim Nat. ● A2
Pcs. Box 10

Chiusura triangolo
4,5x2,6 - 1^{3/4}"x1^{1/6}"
ECS7 Denim Nat. ● A2
Pcs. Box 12

28,5x29,3 - 11^{1/4}"x11^{9/16}"
ECRX Denim Nat. ● A110



Chiusura mezza losanga
2,16x13,6 - 7/8"x5^{3/8}"
ECS3 Grey Nat. ● A2
Pcs. Box 10

Chiusura triangolo
4,5x2,6 - 1^{3/4}"x1^{1/6}"
ECS8 Grey Nat. ● A2
Pcs. Box 12

28,5x29,3 - 11^{1/4}"x11^{9/16}"
ECRY Grey Nat. ● A110



Chiusura mezza losanga
2,16x13,6 - 7/8"x5^{3/8}"
ECS4 Dark Grey Nat. ● A2
Pcs. Box 10





Chiusura triangolo
4,5x2,6 - 1^{3/4}"x1^{1/6}"
ECS9 Dark Grey Nat. ● A2
Pcs. Box 12

28,5x29,3 - 11^{1/4}"x11^{9/16}"
ECRZ Dark Grey Nat. ● A110

* Su rete in fibra - On fibre mesh backing - Sur filet en fibre de verre - Auf Glasfasernetz - Sobre malla de fibra - На волоконной сетке

PEZZI SPECIALI

Trims | Pieces Speciales | Formteile | Piezas Especiales | Специальные Изделия

	Dimensione Size	Ivory	Taupe	Denim	Grey	Dark Grey	Fascia di prezzo Price band
 Battiscopa - Skirting	Nat. Rett. 7x60 - 2 ^{3/4} x23 ^{5/8} " Pcs. Box 15 - LM x Box 9,00	ECPG	ECPH	ECPJ	ECPK	ECPL	● A11
 Gradino - Stair Tread	Nat. Rett. 33x60 - 12 ^{15/16} x23 ^{5/8} " Pcs. Box 6 - LM x Box 3,60	ECP5	ECP6	ECP7	ECP8	ECP9	● A54
 Gradone - Step	Nat. Rett. 33x60x3,2x3,2 12 ^{15/16} x23 ^{5/8} x1 ^{1/4} x1 ^{1/4} " Pcs. Box 4 - LM x Box 2,40	ECNP	ECNQ	ECNR	ECNS	ECNT	● A68
 Angolare Dx Sx Corner Tile Dx Sx	Nat. Rett. 33x60x3,2x3,2 12 ^{15/16} x23 ^{5/8} x1 ^{1/4} x1 ^{1/4} " Pcs. Box 2 - LM x Box 1,20	DX ECNV	DX ECNX	DX ECNZ	DX ECP1	DX ECP3	● A90
		SX ECNW	SX ECNY	SX ECP0	SX ECP2	SX ECP4	

IMBALLI E PESI

Packing and Weight | Emballages et Poids | Verpackung und Gewicht | Embalajes y Pesos | Упаковка и Вес

Formato Size Format Format Тamaño Формат cm	Spessore Thickness Epaisseur Stärke Espesor Толщина mm	Pz. x Mq. Pieces x Sqm Pcs / M ² Stk. x Qm Pzs x Mc. Шт x Кв.М.	Pz. x Scat. Pieces x Box Pcs / Bte Stk. x Krt. Pzs x Caja Шт x Кор.	Mq. x Scat. Sqm x Box M ² / Bte Qm x Krt. Кв.М. x Кор.	Peso x Scat. Weight x Box Poids / Bte Gewicht x Krt. Peso x Caja Вес x Кор. Kg	Scat. x Pal. Boxes x Pal. Bte / Pal. Krt. x Pal. Cajas x Pal. Кор. x Подд.	Mq. x Pal. Sqm x Pal. M ² / Pal. Qm x Pal. Mc. x Pal. Кв.М x Подд.	Peso x Pal. Weight x Pal. Poids / Pal. Gewicht x Pal. Peso x Pal. Вес x Подд. Kg
60x60 Naturale	9,5	2,78	3	1,08	23,76	40	43,20	950
30x60 Naturale	9,5	5,56	6	1,08	23,76	48	51,84	1140
30x60 Dec. Rail Naturale	9,5	5,56	6	1,08	23,76	48	51,84	1140
15x60 Dec. Rail Naturale	9,5	11,11	12	1,08	23,76	50	54,00	1188
30x30 Mosaico 5X5 Naturale	9,5	11,11	5	0,45	8,73	60	27,00	524
30x30 Mosaico Domino Naturale	9,5	11,11	5	0,45	8,73	60	27,00	524
28,5x29,3 Mosaico Arrows Naturale	9,5	11,98	5	0,42	8,73	60	25,02	524



Ivory Nat. Rett.
60x60 - 23^{5/8}x23^{5/8}"

Mosaico Arrows Ivory Nat.
28,5x29,3 - 11^{1/4}x 11^{9/16}"

APPLICAZIONI TECNICHE

Emilgroup mette a disposizione svariate tipologie di applicazioni tecniche per far sì che le eccellenti qualità estetiche e tecniche del gres porcellanato possano essere sfruttate e valorizzate nei contesti progettuali più ambiziosi e sfidanti. Sistemi ad alto coefficiente tecnologico, prestazionale e di innovazione, elaborati fin nei minimi dettagli, e personalizzati su misura, con l'intento di trovare sempre la risposta più adatta e congeniale alle complesse esigenze dell'architettura contemporanea.

TECHNICAL APPLICATIONS Emilgroup makes available a range of technical applications to ensure that porcelain stoneware's exquisite appearance and outstanding technical qualities can be exploited and appreciated to the full in the most ambitious, challenging projects. High-tech, high-performing, extremely innovative systems, specified down to the tiniest details and customised as required, aiming always to deliver the most suitable solution and the best fit for contemporary architecture's complex needs.

APPLICATIONS TECHNIQUES Emilgroup a mis au point plusieurs types d'applications techniques pour que les extraordinaires qualités esthétiques et techniques du grès cérame puissent être exploitées et mises en valeur dans les contextes conceptuels les plus variés et les plus complexes. Ces systèmes s'appuient sur une technologie de pointe, sur une performance de haut niveau et sur une forte innovation. Elaborés dans les moindres détails et personnalisés sur mesure, ils visent à fournir toujours la solution la plus adaptée et la plus juste pour remplir les critères sévères de l'architecture contemporaine.

TECHNISCHE ANWENDUNGSBEREICHE Emilgroup bietet Produkte für verschiedenste Anwendungsbereiche an, so dass die ausgezeichneten technischen und optischen Eigenschaften von Feinsteinzeug selbst in anspruchsvollsten Projekten optimal zur Geltung gebracht werden können. Die hochtechnologischen, leistungsfähigen und innovationsreichen Systeme, bei denen jedes Detail stimmt, warten mit maßgeschneiderten Lösungen auf, die den komplexen Gestaltungsanforderungen der modernen Architektur gerecht werden.

APLICACIONES TÉCNICAS Emilgroup pone a disposición varios tipos de aplicación técnica para conseguir que las excelentes cualidades estéticas y técnicas del gres porcelánico puedan aprovecharse y valorizarse en los contextos proyectivos más ambiciosos y osados. Sistemas de alto coeficiente tecnológico, de prestaciones y de innovación, elaborados hasta en el menor de los detalles, y personalizados a medida, con la intención de hallar siempre la respuesta más adecuada y en sintonía con las complejas exigencias de la arquitectura contemporánea.

ТЕХНИЧЕСКИЕ ПРИМЕНЕНИЯ Emilgroup предлагает продукцию для разнотипного технического применения, предназначенную для полноценного использования и valorизации великолепных эстетических и технических качеств керамогранита в самых амбициозных и смелых дизайнерских проектах. Это - системы с большим содержанием технологии, высокими характеристиками и инновациями, разработанные с учетом мельчайших деталей, индивидуализированные на заказ, для нахождения наиболее подходящего и лучшего ответа на сложные требования современной архитектуры.

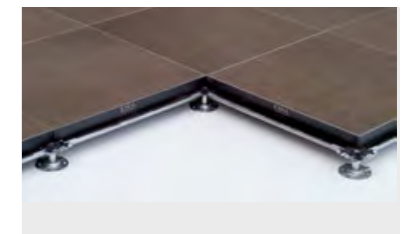

Pave&Go

1

PAVE AND GO

Facciate ventilate

2



Pavimenti sopraelevati

3



PAVE AND GO

INNOVATIVO SISTEMA DI PAVIMENTAZIONE PER INTERNI

Un esclusivo e innovativo sistema ad aggancio per realizzare pavimentazioni interne con la massima facilità, velocità, versatilità e la garanzia di prestazioni tecniche di livello eccezionale. Con Pave and Go, le lastre in gres porcellanato Emilgroup a spessore 10 e 20 mm vengono integrate in un supporto poliuretano dotato di agganci perimetrali che permette un'installazione estremamente semplice, rapida e senza l'utilizzo di massetti in cemento o altri collanti.

INNOVATIVE INDOOR FLOORING SYSTEM An exclusive, innovative interlocking joint system for extremely easy, quick, versatile installation of indoor floorings with guaranteed outstanding technical performances. With Pave and Go, Emilgroup porcelain stoneware tiles 10 and 20 mm thick are integrated in a polyurethane backing with interlocking joints around the edge, allowing very fast, trouble-free installation without the use of cement screeds or other adhesives.

SYSTÈME RÉVOLUTIONNAIRE POUR LE CARRELAGE INTÉRIEUR Un système d'ancrage exclusif et innovant pour mettre en place un carrelage intérieur en toute simplicité, avec la plus grande rapidité et polyvalence, tout en assurant une performance technique exceptionnelle. Dans le système Pave and Go, les dalles en grès cérame Emilgroup, de 10 et 20 mm d'épaisseur, sont incorporées à un support polyuréthane entouré d'ancrages pour garantir une installation extrêmement simple et rapide, sans chapes en ciment ni colles.

INNOVATIVES SYSTEM FÜR BODENBELÄGE IM INNENBEREICH Exklusives und innovatives Klicksystem für Bodenbeläge im Innenbereich: einfache und schnelle Verlegung, große Einsatzvielfalt und erstklassige Leistungsmerkmale. Die Bodenelemente von Pave and Go bestehen aus 10 bzw. 20 mm starken Feinsteinzeugplatten der Emilgroup, die mit einem Trägerelement aus Polyurethan verbunden werden, das umlaufend mit einem Nut-Feder-Verriegelungssystem gesichert ist. Dieses System ermöglicht eine schnelle und unkomplizierte Verlegung, ohne dass Zementestrich oder Kleber erforderlich sind.

INNOVADOR SISTEMA DE PAVIMENTACIÓN PARA INTERIORES Un exclusivo e innovador sistema de fijación para realizar pavimentaciones interiores con la máxima facilidad, velocidad y versatilidad y la garantía de unas prestaciones técnicas de nivel excepcional. Con Pave and Go, las placas de gres porcelánico de Emilgroup, de 10 y 20 mm de grosor, se integran en un soporte de poliuretano dotado de anclajes perimetrales que permite una instalación extremadamente sencilla, rápida y sin el uso de ninguna capa de relleno de cemento ni de otros adhesivos.

ИННОВАЦИОННАЯ СИСТЕМА НАСТИЛА ВНУТРЕННИХ ПОЛОВ Эксклюзивная и инновационная замковая система для чрезвычайно простого, быстрого и практичного настила внутренних полов, а также для обеспечения технических характеристик высочайшего уровня. При использовании Pave and Go керамогранитные плиты Emilgroup толщиной 10 и 20 мм устанавливаются на полиуретановую опору с периметральными креплениями, что позволяет выполнять чрезвычайно простую, быструю установку, без изготовления бетонных стяжек или же использования клеящих веществ.

Si consiglia di utilizzare Pave and Go Indoor 18 mm per interni residenziali e pubblici dove non transitano o stazionano carichi pesanti, mentre si consiglia di utilizzare Pave and Go Indoor 28 mm per pubblici e commerciali ad alto traffico perchè supporta un peso fino a 2000kg.

Pave and Go Indoor 18 mm is recommended for residential and public interiors without permanent or transient heavy loads, while Pave and Go Indoor 28 mm is recommended for intensively used public and commercial locations, since it withstands a weight up to 2000 kg.

Il est recommandé de poser Pave and Go Indoor 18 mm dans les intérieurs résidentiels et publics sans circulation ni présence de charges lourdes. Pave and Go Indoor 28 mm, par contre, peut être utilisé dans les lieux publics et commerciaux à passage intensif, en raison de sa résistance jusqu'à 2 000 kg.

Pave and Go Indoor 18 mm wird für private und öffentliche Innenbereiche empfohlen, in denen keine hohen Einzel- oder Verkehrslasten anfallen. Pave and Go Indoor 28 mm hingegen besitzt eine Tragfähigkeit bis zu 2.000 kg und ist daher für stark frequentierte öffentliche und gewerbliche Bereiche geeignet.

Se aconseja utilizar Pave and Go Indoor de 18 mm para revestir interiores residenciales y públicos por los que no vayan a transitar ni permanecer cargas pesadas. En cambio, se recomienda usar Pave and Go Indoor de 28 mm para cubrir superficies públicas y comerciales de tráfico intenso, pues esta versión soporta un peso de hasta 2000 kg.

Рекомендуется использовать Pave and Go Indoor 18 мм для отделки внутренних жилых и общественных площадей, на которые не оказываются высокие динамические и статические нагрузки, в то время как, Pave and Go Indoor 28 мм рекомендуется использовать в общественных и торговых объектах с высокой интенсивностью трафика, потому что этот материал выдерживает вес до 2000 кг.

SISTEMA AD INCASTRO MASCHIO-FEMMINA

Male-female interlocking joint system
Système à encastrement mâle-femelle
Nut-Feder-Verriegelungssystem
Sistema de encaje machihembrado
Система внутренних и наружных креплений

SUPPORTO IN POLIURETANO

Polyurethane backing
Support polyuréthane
Trägerplatte aus Polyurethan
Soporte de poliuretano
Полиуретановая основа

GRES PORCELLANATO 60X60 CM - 23^{5/8}"X 23^{5/8}" SPESSORE 9,5 E 20 MM

Porcelain Stoneware of 60x60 cm - 23^{5/8}" x 23^{5/8}" Thickness 9,5 and 20 mm
Grès cérame 60x60 cm - 23^{5/8}" x 23^{5/8}" Épaisseur 9,5 et 20 mm
Feinsteinzeug 60x60 cm - 23^{5/8}" x 23^{5/8}" Stärke 9,5 mm und 20 mm
Gres porcelánico de 60x60 cm - 23^{5/8}" x 23^{5/8}" de 9,5 y 20 mm de grosor
Керамогранит 60x60 см. 23^{5/8}" x 23^{5/8}" - толщина 9,5 и 20 мм

FUGA PERIMETRALE 2 MM (4 MM CON PIASTRELLE UNITE)

Perimeter joint of 2 mm (4 mm with tiles laid side by side)
Joint 2 mm (4 mm avec carreaux l'un à côté de l'autre)
Umlaufende Fuge 2 mm (4 mm zwischen den verriegelten Fliesen)
Junta perimetral de 2 mm (4 mm con azulejos yuxtapuestos)
Периметральный шов 2 мм (4 мм при соединенных плитках)

SPESSORE MODULO 18 MM E/O 28 MM

Module thickness 18 mm and/or 28 mm
Épaisseur Module 18 mm et/ou 28 mm
Modulstärke 18 mm und/oder 28 mm
Módulo de 18 mm y/o de 28 mm de grosor
Толщина модуля 18 мм или 28 мм

TEMPO DI POSA? 5 VOLTE INFERIORE RISPETTO AGLI ALTRI SISTEMI!

**INSTALLATION TIME?
5 TIMES LESS THAN WITH
OTHER SYSTEMS!** With the Pave
and Go one-click interlocking
joint installation system,
specifically developed for indoor
ceramic flooring, tiles can be
installed quickly and easily on
screeds or on top of existing
floorings. The tiles are just aligned
and clicked together to create a
paving ready for use at once.

**TEMPS DE POSE ?
5 FOIS PLUS RAPIDE QUE LES
AUTRES SYSTEMES!** Le système
Pave and Go à encastrement,
par simple clic, est fait tout
spécialement pour poser des
revêtements de sol en céramique
à l'intérieur. Il permet d'installer
les carreaux facilement et
rapidement sur des chapes ou
sur d'anciens revêtements de sol.
Il suffit de les aligner, puis de les
encastrer en un clic pour obtenir
un revêtement de sol utilisable
immédiatement.

**VERLEGEZEIT? EIN FÜNFTEL
DES ZEITAUFWANDS IM
VERGLEICH ZU ANDEREN
SYSTEMEN!** Das eigens für
keramische Bodenbeläge
im Innenbereich konzipierte
Klicksystem Pave and Go
ermöglicht die einfache und
zügige Verlegung von Fliesen
auf Estrich oder Altböden.
Der begehbare Bodenbelag
ist im Handumdrehen fertig;
die Fliesen brauchen lediglich
aneinandergelegt und
festgeklickt zu werden.

**¿TIEMPO DE COLOCACIÓN?
¡CINCO VECES INFERIOR
RESPECTO AL DE OTROS
SISTEMAS!** El sistema de
colocación mediante encaje con
clic Pave and Go, concebido ex
profeso para pavimentaciones de
cerámica para interiores, permite
colocar los azulejos de modo fácil
y rápido sobre capas de relleno o
sobre viejas pavimentaciones.
No hay más que alinearlas y
encajarlas con un simple clic para
contar con una pavimentación
que se puede pisar de inmediato.

**ВРЕМЯ УКЛАДКИ?
В 5 РАЗ МЕНЬШЕ, ЧЕМ
ПРИ УКЛАДКЕ ДРУГИХ
СИСТЕМ!**
Замковая система укладки
Pave and Go, специально
разработанная для настила
внутренних керамических
полов, позволяет легко и
быстро укладывать плиты
на стяжки или старые полы.
Необходимо лишь выровнять
их и состыковать замок, после
чего поверхность будет сразу
же пригодна для хождения.

Il sistema di posa a incastro con un clic Pave and Go, concepito appositamente per pavimentazioni in ceramica per interni, permette di posare le piastrelle facilmente e velocemente su massetti o su vecchie pavimentazioni. Occorre soltanto allinearle e incastrarle con un clic per ottenere una pavimentazione immediatamente calpestabile.



PULITO? NO COLLA! NO STUCCO! CALPESTABILE? SUBITO!

Per l'installazione del sistema Pave and Go bastano pochi attrezzi di uso comune e non occorrono malte, colle, massetti o altri prodotti chimici.

Grazie a ciò, non sono richiesti tempi di attesa, né particolari operazioni di pulizia, prima che i vostri clienti possano calpestare le superfici posate, ad esempio in un ufficio o ristorante o in un supermercato. L'installazione può avvenire anche contestualmente all'utilizzo del locale, pertanto non è necessario avere periodi di chiusure o fermi lavorativi. Pave and Go 28 mm è anche carrabile con una portata fino a 2000 kg.

CLEAN? NO GLUE! NO GROUT! READY FOR USE? AT ONCE! All it takes to install the Pave and Go system are a few standard tools, with no need for mortars, glues, screeds or other chemical products. This means there are no waiting times, or specific cleaning procedures, before your customers can start using the installed surfaces, in an office, restaurant or supermarket, for example. Installation can be carried out while the premises are in use, since no closures or stoppages for the works are required. Pave and Go 28 mm is also vehicle-resistant with load capacity up to 2000 kg.

PROPRE ? PAS DE COLLE ! PAS DE MORTIER ! UTILISABLE APRÈS COMBIEN DE TEMPS ? IMMÉDIATEMENT ! Quelques outils d'usage courant suffisent pour mettre en place le système Pave and Go, sans mortiers, colles, chapes ou autres produits chimiques. Autrement dit, pas de temps d'attente, pas d'interventions particulières de nettoyage avant que vos clients puissent marcher sur les surfaces posées, par exemple dans un bureau, un restaurant ou un supermarché. L'installation peut se faire pendant que le local est utilisé, autrement dit pas besoin de fermer ou d'interrompre l'activité professionnelle. Pave and Go 28 mm est aussi un sol carrossable, avec une résistance jusqu'à 2 000 kg.

SAUBER? KEIN KLEBER! KEINE FUGENMASSE! BEGEBBAR? SOFORT! Für die Verlegung des Systems Pave and Go reichen einige wenige branchenübliche Werkzeuge und sind keine Mörtel, Kleber, Estriche oder anderweitigen chemischen Erzeugnisse erforderlich. Folglich entfallen Wartezeiten und Reinigungsarbeiten, so dass die Belagflächen, etwa im Büro, im Restaurant oder im Supermarkt, sofort begehbar sind. Die Verlegung kann auch während des laufenden Betriebs vorgenommen werden, so dass keine Schließzeiten und Arbeitsausfälle entstehen. Pave and Go 28 mm ist auch mit Lasten bis zu 2.000 kg befahrbar.

¿LIMPIO? ¡SIN COLA! ¡SIN ESTUCOS! ¿TRANSITABLE? ¡EN SEGUIDA! Para la instalación del sistema Pave and Go son suficientes unas pocas herramientas de uso común y no se requieren morteros, colas, capas de relleno ni otros productos químicos. Por todo ello no van a ser necesarias operaciones de limpieza especiales ni ningún tiempo de espera antes de que tus clientes puedan transitar por las superficies colocadas, por una oficina, un restaurante o un supermercado, por ejemplo. La instalación se puede efectuar incluso simultáneamente al uso del local, por lo que no se requerirán periodos de cierre ni paradas para la ejecución de las obras. Por las superficies soladas con Pave and Go de 28 mm de grosor también pueden transitar vehículos de hasta 2000 kg de peso.

ЧИСТО? БЕЗ КЛЕЯ! БЕЗ ЗАТИРКИ! ВОЗМОЖНОСТЬ ХОЖДЕНИЯ? СРАЗУ! Для установки систем Pave and Go достаточно немного обычного инструмента и не требуется раствор, клей, стяжки или другие химические продукты. Благодаря этому не требуется время выдержки, а также выполнение особых операций чистки перед тем, как ваши клиенты начнут хождение по полу, например, в офисе, ресторане или супермаркете. Установку можно выполнять также и во время использования помещения, поэтому, самоустраниются периоды закрытия и прекращения работы. Благодаря выдерживаемой нагрузке в 2000 кг Pave and Go 28 мм допускает также движение транспортных средств.

AND IF I WANT TO CHANGE SOME ELEMENTS? VERY SIMPLE! Pave and Go elements are very easy to replace if necessary. Want to change the pattern? Broken or damaged element? You can remove single elements or whole groups - it's no problem with the removal tool. Replacement can be carried out while the premises are in use, since no closures or stoppages for the works are required.

ET POUR REMPLACER DES DALLES ? SUPER SIMPLE! Le cas échéant, les dalles Pave and Go peuvent être remplacées en toute simplicité. En cas de changement de design ? Une dalle s'est cassée ou abîmée ? Vous pouvez retirer une dalle seulement ou des groupes entiers. Avec l'outil de dépose, aucun problème. Le remplacement peut se faire pendant que le local est utilisé, autrement dit pas besoin de fermer ou d'interrompre l'activité professionnelle.

UND WENN DIE PLATTEN AUSGETAUSCHT WERDEN SOLLEN? EIN KINDERSPIEL! Die Module des Systems Pave and Go können bei Bedarf im Nu ausgetauscht werden. Neuer Look gefällig? Platte defekt? Die Platten können einzeln oder gruppenweise problemlos mit dem Hebewerkzeug entfernt werden. Der Austausch kann auch während des laufenden Betriebs vorgenommen werden, so dass keine Schließzeiten und Arbeitsausfälle entstehen.

¿Y SI QUIESIERA CAMBIAR LAS PLACAS? ¡MUY FÁCIL! Las placas Pave and Go se pueden cambiar con extraordinaria facilidad, si es necesario. ¿Quieres cambiar el diseño? ¿Se ha roto o estropeado una placa? Con una ventosa u otra herramienta para la extracción, retirar una placa o quitar todo un conjunto de ellas no va a ser un problema. El cambio se puede llevar a cabo incluso simultáneamente al uso del local, por lo que no se requerirán períodos de cierre ni paradas para la ejecución de las obras.

ЗАМЕНА ПЛИТ? ПРОЩЕ НЕ БЫВАЕТ! В случае необходимости плиты Pave and Go можно очень легко заменить. Хотите изменить дизайн? Одна плитка разбилась или повредилась? Вы можете снять отдельные плиты или же целые группы. Благодаря съемному приспособлению это не является проблемой. Замену можно выполнять также и во время использования помещения, поэтому, самоустраиваются периоды закрытия и прекращения работы.



SOSTITUIRE LE LASTRE? SEMPLICISSIMO!

Le lastre Pave and Go possono essere sostituite con estrema facilità, se necessario. Volete cambiare il design? Una lastra si è rotta o rovinata? Potete togliere singole lastre o interi gruppi - con l'attrezzo di rimozione non è un problema. La sostituzione può avvenire anche contestualmente all'utilizzo del locale, pertanto non è necessario avere periodi di chiusure o fermi lavorativi.



È FACILE DA PULIRE? ASSOLUTAMENTE SÌ! FORMIDABILE!

I vostri clienti saranno soddisfatti del risultato: la pavimentazione, con le sue fughe integrate, sarà una superficie unica e continua. Le piastrelle in ceramica si contraddistinguono per le gradevoli tonalità di colore e la loro robustezza permette di mantenere nel tempo la bellezza delle strutture. Anche la manutenzione di una pavimentazione interna non è mai stata così facile! Le superfici sono resistenti alla sporcizia e possono essere pulite facilmente con comuni detersivi per piastrelle.



IS IT EASY TO CLEAN? ABSOLUTELY! INCREDIBLE! Your customers will be delighted with the result: the paving, with its integrated joints, will form a single, continuous surface. Thanks to the attractive colours and strength of the ceramic tiles, the structure will retain its beauty over time. Taking care of an indoor flooring has also never been so easy! The surfaces are resistant to dirt and can easily be cleaned with ordinary tile cleaners.

C'EST SIMPLE À NETTOYER ? ABSOLUMENT ! FORMIDABLE ! Vos clients adoreront le résultat : le revêtement de sol, avec ses joints intégrés, sera une surface unique et continue. Les carreaux en céramique se distinguent par leurs superbes nuances de couleur, et leur solidité assure la beauté des structures à très long terme. L'entretien d'un sol intérieur n'a jamais été aussi simple ! Les surfaces sont résistantes à la saleté. Elles peuvent être nettoyées avec des détergents ordinaires pour carrelage.

PFLEGELEICHT? SUPERPFLEGELEICHT! Ihre Kunden werden zufrieden sein: der Bodenbelag mit integrierten Fugen bildet eine nahtlose, einheitliche Fläche. Die Keramikfliesen zeichnen sich durch attraktive Farbtönen und eine hohe Langzeitqualität aus, was für einen dauerhaft schönen Bodenbelag bürgt. Die Pflege eines Indoor-Bodenbelags war noch nie so einfach! Die Oberflächen sind schmutzabweisend und können problemlos mit allen gängigen Fliesenreinigern gereinigt werden.

¿ES FÁCIL DE LIMPIAR? ¡SÍ, SIN DUDA! ¡FORMIDABLE! Tus clientes estarán satisfechos con el resultado: la pavimentación, con sus juntas integradas, configurará una superficie única y continua. Los azulejos de cerámica se distinguen por presentar unas agradables tonalidades cromáticas y su solidez permite mantener durante largo tiempo la belleza de las estructuras. ¡Además, el mantenimiento de un pavimento interior jamás ha sido tan fácil! Las superficies, resistentes a la suciedad, se pueden limpiar fácilmente con detergentes corrientes para azulejos.

ОНА ЛЕГКО ЧИСТИТСЯ? НЕСОМНЕННО! ПОРАЗИТЕЛЬНО! Ваши клиенты останутся довольны результатом: пол с интегрированными швами станет единой и сплошной поверхностью. Керамическая плитка отличается приятным цветом, а ее прочность позволяет сохранить во времени красоту конструкций. Даже уход за полом в помещении никогда не был столь простым! Поверхности устойчивы к загрязнению и могут легко очищаться обычными моющими средствами для плитки.



DESTINAZIONI D'USO

Pave and Go è la scelta ideale per tutti i contesti commerciali, pubblici e di lavoro nei quali è richiesto il perfetto bilanciamento tra estetica, praticità e prestazioni.

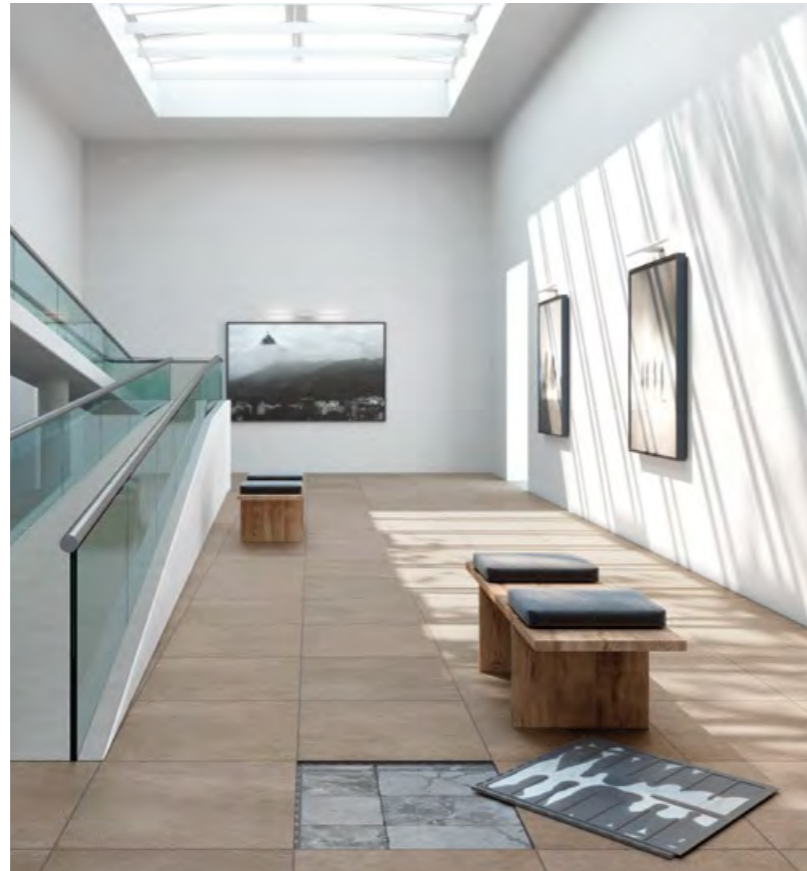

INTENDED USES Pave and Go is the ideal option for all commercial, public and working locations that demand the perfect combination of looks, convenience and performance.

DOMAINES D'APPLICATION Pave and Go est le choix idéal pour tous les projets commerciaux, publics et professionnels exigeant un parfait équilibre entre esthétique, fonctionnalité et performance.

ZWECKBESTIMMUNG Pave and Go ist ideal für alle gewerblichen, öffentlichen und Bürobereiche, in denen ein perfektes Zusammenspiel von Ästhetik, Zweckmäßigkeit und Leistungsmerkmalen erforderlich ist.

USOS PREVISTOS Pave and Go es la opción ideal para todos los contextos comerciales, públicos y laborales en los que se requiera un perfecto equilibrio entre estética, practicidad y prestaciones.

НАЗНАЧЕНИЕ Pave and Go - это наилучший выбор для любого применения: торговых площадей, общественных заведений и рабочих помещений, в которых требуется сбалансированность эстетики, практичности и высоких характеристик.

I NOSTRI DESIGN

Pave and Go Indoor offre una ricca scelta di proposte grafiche e stilistiche all'interno delle collezioni Emilgroup nel formato 60x60 cm a spessore 10 mm e 20 mm.

Pave and Go Indoor 28 mm è disponibile su richiesta per progetti superiori ai 2000 mq.

Pave and Go Indoor 28 mm is available on request for projects in excess of 2000 m².
 Pave and Go Indoor 28 mm est disponible sur demande pour les projets de plus de 2000 m².
 Pave and Go Indoor 28 mm ist auf Anfrage für Projekte über 2000 qm erhältlich.
 Pave and Go Indoor 28 mm se halla disponible bajo pedido para proyectos superiores a los 2000 m².
 Pave and Go Indoor 28 mm поставляются на заказ для проектов площадью от 2000 кв.м.



OUR DESIGNS Pave and Go Indoor offers a rich selection of patterns and styles from the Emilgroup collections in the 60x60 cm size with thickness of 10 and 20 mm.

LES DESIGNS Pave and Go Indoor multiplie les textures graphiques et les styles au sein des collections Emilgroup en format 60x60 cm, d'épaisseur 10 et 20 mm.

DESIGNVIELFALT Pave and Go Indoor bietet eine mannigfaltige Auswahl an Optiken und Stilen aus den Kollektionen der Emilgroup im 10 mm und 20 mm starken Format 60x60 cm.

LOS DISEÑOS Pave and Go Indoor ofrece una generosa selección de variantes gráficas y estéticas dentro de las colecciones de Emilgroup en el formato de 60 x 60 cm, de 10 y de 20 mm de grosor.

НАШ ДИЗАЙН Pave and Go Indoor предлагает большой выбор графических и стилистических предложений в рамках коллекций Emilgroup в формате 60x60 см толщиной 10 и 20 мм.

INSTALLAZIONE

INSTALLATION
INSTALLATION
VERLEGUNG
INSTALACIÓN
УСТАНОВКА

1

Check that the installation screed or existing flooring is clean and flat.

Avant la pose, contrôler que la chape, ou l'ancien revêtement de sol, présente une surface propre et plate.

Kontrollieren, dass Estrich bzw. Altboden sauber und eben sind.

Comprobar que la capa de relleno o el pavimento viejo sobre el que va a ejecutarse el solado sea plano y esté limpio.

Убедитесь, что имеющаяся стяжка или пол, на который будет осуществляться укладка, является чистым и ровным.

2

Install the first element, placing it perpendicular with the adjacent walls.

Poser la première dalle de manière qu'elle soit parfaitement droite par rapport aux murs adjacents.

Die erste Platte rechtwinklig beginnend an der Wanddecke verlegen.

Colocar la primera placa en ángulo recto con respecto a las paredes adyacentes.

Уложите первую плиту перпендикулярно расположенным рядом стенам.

3-4

Continue installing, interlocking all elements on the right side, until the space is full.

Continuer la pose en encastrant les dalles toujours sur le côté droit jusqu'à remplir tout l'espace.

Die nächste Platte anlegen und festklicken. Bei der Verlegung von rechts nach links arbeiten, bis die Reihe vollständig ist.

Seguir con la colocación encajando las placas del lado derecho hasta llegar al final del espacio disponible.

Продолжите укладку, прикладывая и закрывая на замок плиты с правой стороны, до конца свободного места.

5

When the first row is complete, start again from the beginning, always ensuring that the elements are perpendicular.

Une fois terminée la première rangée, recommencer depuis le début en contrôlant toujours que les dalles sont parfaitement droites.

Nach Beendigung der ersten Reihe die zweite Reihe erneut von rechts beginnen und stets darauf achten, dass die Platten rechtwinklig verlegt sind.

Una vez colocada la primera fila seguir desde el principio asegurándose siempre de que las placas estén en ángulo recto.

Завершив первый ряд, начните укладку второго ряда от начала, всегда проверяя перпендикулярность сторон плит.



1

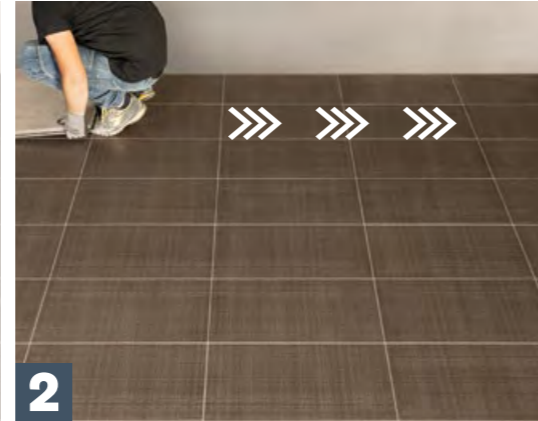

2

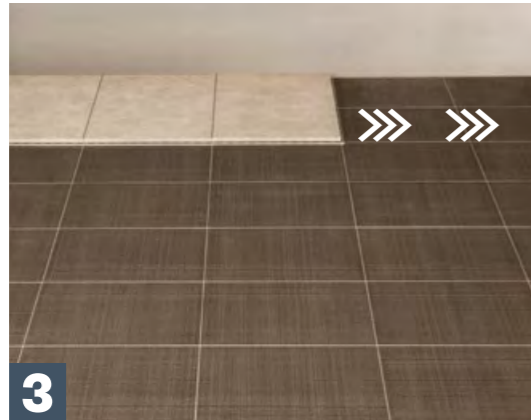

3



4

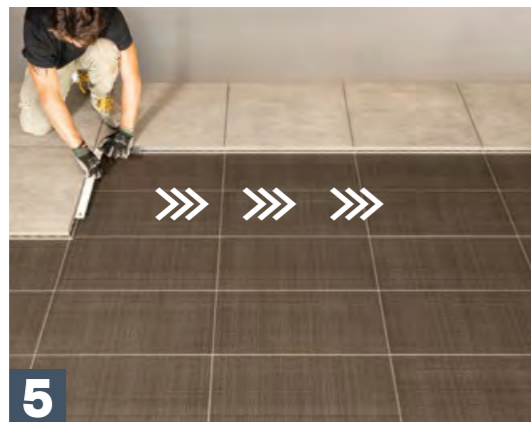

5



6

1 Verificare che il massetto o il pavimento pre-esistente su cui si eseguirà la posa sia pulito e planare.

2 Posare la prima lastra posizionandola in squadra con le pareti adiacenti.

3-4 Proseguire la posa incastrando le lastre sempre sul lato di destra fino alla fine dello spazio.

5 Una volta terminata la prima file riprendere dall'inizio verificando sempre lo squadra delle lastre.

7

When done, cut elements to size around the edges if necessary.

Le cas échéant, procéder à des découpes périphériques.

Sofern erforderlich, nach Fertigstellung die Elemente für die Randbereiche schneiden.

Una vez terminado el trabajo efectuar los cortes perimetrales, si son necesarios.

После завершения работ выполните периметральную резку, если таковая необходима.



7



8

8

Elements can be cut with a tile cutter or angle-grinder.

Les dalles peuvent être découpées avec un coupe-carrelage ou une meuleuse d'angle.

Zum Schneiden der Platten eine Fliesenschneidmaschine oder einen Trennschneider verwenden.

Las placas se pueden cortar con un cortabalados o una sierra circular de mano.

Плиты можно резать плиткорезом или же болгаркой.



9



10

9

Cutting of the PUR using a jigsaw with laminate blade.

Découper le matériel synthétique à base de polyuréthane avec une scie sauteuse munie d'une lame pour laminé et stratifié.

Schneiden des PUR-Kunststoffes mittels Stichsäge mit Laminat-Sägeblatt.

Cortar el material sintético a base de poliuretano con una sierra de calar con cuchilla para laminado.

Разрежьте синтетический материал на полиуретановой основе ножом.

10

Fill any gaps between the elements and the wall with silicone.

Au besoin, remplir de silicone l'espace entre les dalles et le mur.

Den Abstand zwischen Platte und Wand ggf. mit Silikon ausfüllen.

Si es necesario, rellenar con silicona el intersticio entre las placas y la pared.

В случае необходимости заполните силиконом шов между плитами и стеной.

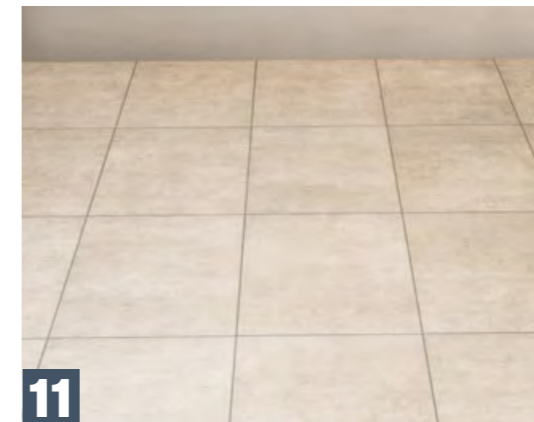

11



12

7 A lavoro terminato procedere se necessario ad effettuare i tagli perimetrali.

8 Le lastre possono essere tagliate con una taglierina per piastrelle o flessibile.

9 Tagliare il materiale sintetico a base di poliuretano con un cutter.

10 Se necessario eseguire riempimento con silicone tra le lastre ed il muro.

CARATTERISTICHE TECNICHE E GARANZIA



SISTEMA PAVE&GO 18MM

SIZE AND GENERAL INFORMATION	UNIT	SPECIFICATION
System size ¹	mm	602 x 602
Total System height ²	mm	18.0
Surface		ceramic tile
Tile size ³	mm	598 x 598 x 9.5
Backside of the flooring system		Polyurethane bars and locking system
Storage		Indoor storage is recommended
Laying temperature		-5 to + 35°C ⁴
UV resistance		Requirements fulfilled: no cracks, no blistering ⁵
Thermal Shock resistance According to EN 10545-9: 2000		PASS
INFORMATION FOR INSTALLATION		
Installation methods		cross-bond, half-offset or random structure
Possible staggered installation (multiples of)	mm	50
Usage		indoor areas
Floor heating		suitable ⁶
DATA FOR THE LAID ELEMENTS ⁷		
Weight approx.	kg / m ²	26
Average width of joint	mm	3
Fire behaviour according to DIN EN 13501(2010-01)		Bfl-s1
Resistance of the joints to liquids		Very good ⁸
Heat transfer resistance R	m ² K/W	0.124 ⁹
Anti-Slip-Class, abrasive-strength		According to the series - Technical Sheet
LOAD VALUES / TYPES OF USE ON A LEVELLED SURFACE		
Payload: Pallet truck with polyurethane or rubber wheels	kg	600
Point load at 2.5 x 2.5 cm	kg	275 ¹⁰
Possible applications: office space, shop-in-shop and pop-up systems, low loaded salesrooms.		
LOAD VALUES ON SUBFLOORS ¹¹		
Payload: Pallet truck with polyurethane or rubber wheels	kg	450
Point load at 2.5 x 2.5 cm	kg	200 ¹²
Possible applications: exhibition stands, private rooms, office space, low loaded salesrooms.		

¹ Tolerance element size: -0,0% / +0,07% of the nominal dimension.

² Thickness tolerance: ±5% of the nominal dimension.

³ See tile's tolerance from pag. 1, Ceramic Tile Technical Sheet.

⁴ For an easier installation, a previous storage of the elements in a closed room for 2 days is recommended; the more suitable room temperature for the storage must be kept above 15° C/59° F).

⁵ Color changes can still occur due to UV exposure or chemicals.

⁶ For floor heating, an object-related examination / calculation must be carried out by the specialist planner heating or heating engineer. Thermal resistance without heat transfer resistance R_{SI}.

⁷ Observe the Information on laying floor system Pave & Go.

⁸ Polyurethane as material for the joints does not absorb any liquids. Stains can be removed. Organic liquids, especially solvents, can cause changes in colour when left too long on the joints.

Please refer to Pave & Go the cleaning instructions for flooring system.

⁹ For floor heating, an object-related examination / calculation must be carried out by the specialist planner heating or heating engineer. Thermal resistance without heat transfer resistance R_{SI}.

¹⁰ Tested with tiles with a thickness of 10,0 mm and an average bending resistance of 50N/mm².

¹¹ In accordance with DIN 18202 increased requirements - Table 3 - line 4.

¹² Tested with tiles with a thickness of 10,0 mm and an average bending resistance of 50N/mm².

CARATTERISTICHE TECNICHE E GARANZIA



SISTEMA PAVE&GO 28MM

SIZE AND GENERAL INFORMATION	UNIT	SPECIFICATION
System size ¹	mm	602 x 602
Total System height ²	mm	28.0
Surface		ceramic tile
Tile size ³	mm	598 x 598 x 20.0
Backside of the flooring system		Polyurethane bars and locking system
Storage		Indoor storage is recommended
Laying temperature		-5 to + 35°C ⁴
Measurement of the walking noise in the test facility according to EN 16205		L _{n,walk,A} = 99 dB(A) - (98.7 dB(A) ± 0.2 dB(A).
Test of the improvement of impact sound insulation in the ceiling test facility According to EN ISO 10140		ΔL _w (C _i , Δ) = 15 (-10) dB
UV resistance		Requirements fulfilled: no cracks, no blistering ⁵
Thermal Shock resistance According to EN 10545-9: 2000		PASS
INFORMATION FOR INSTALLATION		
Installation methods		cross-bond, half-offset or random structure
Possible staggered installation (multiples of)	mm	50
Usage		indoor areas
Floor heating		suitable ⁶
DATA FOR THE LAID ELEMENTS ⁷		
Weight approx.	kg / m ²	46
Average width of joint	mm	4
Fire behaviour according to DIN EN 13501(2010-01)		Bfl-s1
Resistance of the joints to liquids		Very good ⁸
Heat transfer resistance R	m ² K/W	0.133 ⁹
Anti-Slip-Class, abrasive-strength		According to the series - Technical Sheet
LOAD VALUES ON SUBFLOORS ¹⁰		
Payload: Pallet truck with polyurethane or rubber wheels	kg	2000
Point load at 2.5 x 2.5 cm	kg	800 ¹¹
Possible applications: Showrooms commercial vehicles, retail space - shop fitting, public buildings. Forklift truck and electric lift truck up to max. 2800 kg. ³		

¹ Tolerance element size: -0,0% / +0,07% of the nominal dimension.

² Thickness tolerance: ±5% of the nominal dimension.

³ See tile's tolerance from pag. 1, Ceramic Tile Technical Sheet.

⁴ For an easier installation, a previous storage of the elements in a closed room for 2 days is recommended; the more suitable room temperature for the storage must be kept above 15° C/59° F).

⁵ Color changes can still occur due to UV exposure or chemicals.

⁶ For floor heating, an object-related examination / calculation must be carried out by the specialist planner heating or heating engineer. Thermal resistance without heat transfer resistance R_{SI}.

⁷ Observe the Information on laying floor system Pave & Go.

⁸ Polyurethane as material for the joints does not absorb any liquids. Stains can be removed. Organic liquids, especially solvents, can cause changes in colour when left too long on the joints.

Please refer to Pave & Go the cleaning instructions for flooring system.

⁹ For floor heating, an object-related examination / calculation must be carried out by the specialist planner heating or heating engineer. Thermal resistance without heat transfer resistance R_{SI}.

¹⁰ In accordance with DIN 18202 increased requirements - Table 3 - line 4.

¹¹ Ibidem.

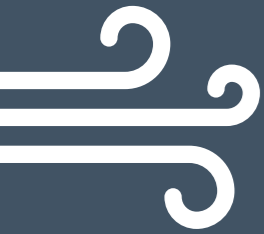

FACCIAE VENTILATE

La facciata ventilata (o parete ventilata) è un particolare tipo di rivestimento perimetrale delle pareti che prevede l'applicazione a secco, sulla superficie esterna dell'edificio, di pannelli di opportuno spessore, che non aderiscono alla parete di tamponamento ma ne risultano distanziati per formare un'intercapedine.

In questo modo, si ottiene la circolazione naturale dell'aria nello spazio dell'intercapedine, per effetto del moto convettivo prodotto dalla presenza di aperture disposte alla base e alla sommità della facciata. Tali facciate determinano il comfort (termo-acustico) degli ambienti interni e influenzano l'architettura del contesto esterno nel quale s'inseriscono.

Il team Engineering di Emilgroup è la struttura dedicata a supportare a 360° il cliente nella progettazione, installazione e certificazione dei sistemi di rivestimento superficiale per interni ed esterni.

Il team Engineering, con il suo approccio "taylor made" garantisce sicurezza e durabilità dell'intervento e assicura il massimo controllo dei fattori interni (disegno e morfologia dell'edificio) ed esterni (posizionamento dell'edificio rispetto ad aspetti di ventosità, sismicità, vicinanza al mare o altitudine particolare).

Emilgroup progetta e sviluppa i diversi sistemi di Parete Ventilata e Facciata Isolata Ventilata in grado di soddisfare le più svariate esigenze stilistiche e progettuali.



VENTILATED FAÇADE

A ventilated facade is a special type of surface for the outsides of walls in which panels of the appropriate thickness are dry-mounted on the building's outer surface in such a way that they do not adhere to the wall itself, meaning that a cavity is formed between the two layers. This allows air to circulate naturally through the cavity, due to the convection effect generated by openings at the top and bottom of the facade. Facades of this type increase the comfort level (temperature and noise) of the rooms inside the building and contribute to the architecture of their surrounding outdoor context.

The Emilgroup Engineering team has been specifically created to assist customers with all aspects of the design, installation and certification of indoor and outdoor surface covering systems. With its tailor-made approach, the Engineering team assures projects' safety and durability, as well as the maximum control of all factors, both internal (building design and layout) and external (positioning of the building in relation to wind direction, seismic risk, nearness to the sea or extreme altitudes).

Emilgroup designs and develops Ventilated Façade and Insulated Ventilated Façade systems capable of satisfying the most widely varying stylistic and architectural needs.

FAÇADE VENTILÉE

La façade ventilée (ou mur ventilé) est un revêtement particulier des murs par l'application à sec, sur la surface extérieure du bâtiment, de panneaux d'épaisseur adéquate qui, au lieu d'être posés directement sur le mur-écran, sont posés à une certaine distance pour former un vide technique. L'air peut ainsi circuler naturellement dans le vide technique par l'effet de convection généré par les ouvertures pratiquées à la base et au sommet de la façade. Ces façades assurent le confort (thermique et phonique) à l'intérieur et elles influencent l'architecture de l'environnement extérieur dans lequel elles s'inscrivent.

L'équipe Engineering d'Emilgroup assiste le client du début à la fin : étude de projet, installation et certification des systèmes de revêtement pour intérieur et extérieur. L'équipe Engineering adopte une approche « personnalisée » pour garantir la sécurité et la durabilité de l'intervention, ainsi que pour examiner et maîtriser les facteurs internes (géométrie et morphologie du bâtiment) et externes (exposition du bâtiment au vent, position dans une zone sismique, à proximité de la mer ou à une altitude particulière).

Emilgroup conçoit et réalise des systèmes de façade ventilée et de façade isolée ventilée qui répondent aux exigences stylistiques et conceptuelles les plus disparates.

VORGEHÄNGTE HINTERLÜFTETE FASSADE

Die vorgehängte hinterlüftete Fassade (VHF) ist eine Außenwandbekleidung im Trockenbausystem. Aufgrund der besonderen Konstruktionsweise werden die Fassadenplatten in geeigneter Stärke nicht direkt an der Gebäudewand angebracht, sondern es wird ein Zwischenraum belassen. In diesem Zwischenraum, auch Hinterlüftungsraum genannt, befindet sich ein natürlicher Luftstrom. Er wird hervorgerufen durch die thermische Konvektion, die aufgrund des Kamineffekts in der Fassade (oben und unten offene Ausführung) entsteht. Vorgehängte hinterlüftete Fassaden optimieren den Klima- und Geräuschkomfort in Innenräumen und werten das bauliche Umfeld auf.

Das Engineering-Team der Emilgroup unterstützt den Kunden rundum bei der Planung, Installation und Zertifizierung von Belagsystemen für Innen- und Außenbereiche. Das Engineering-Team bietet maßgeschneiderte Lösungen und bürgt so für ihre Sicherheit und Langzeitqualität. Gebäudeinterne (Gebäudeform und -aufbau) wie gebäudeexterne Einflussfaktoren (Gebäuelage in Bezug auf Windbelastung, Seismizität, Meeresnähe oder Höhenlage) werden genau unter die Lupe genommen.

Die Emilgroup plant und entwickelt vorgehängte hinterlüftete und gedämmte Fassadensysteme, die unterschiedlichsten Stil- und Projektanforderungen gerecht werden.

FACHADA VENTILADA

La fachada ventilada (o pared ventilada) es un tipo de revestimiento perimetrico especial de las paredes que prevé la aplicación en seco, sobre la superficie exterior del edificio, de paneles de un grosor adecuado que no están adheridos a la pared estructural del edificio sino que están ligeramente separados de la misma para formar una cámara aislante. De este modo se consigue que el aire circule de manera natural en el espacio de la cámara, por efecto del movimiento de convección generado por la presencia de aberturas dispuestas en la base y en la parte superior de la fachada. Estas fachadas determinan el confort (térmico y acústico) de los ámbitos interiores e influyen en la arquitectura del contexto exterior en el que se hallan.

El equipo de Ingeniería de Emilgroup es el departamento que le presta total apoyo y asesoramiento al cliente en la proyección, instalación y certificación de los sistemas de revestimiento superficial para interiores y exteriores. El equipo de Ingeniería, con su enfoque "a medida" garantiza la seguridad y la durabilidad de la intervención así como el máximo control de los factores interiores (dibujo y morfología del edificio) y exteriores (ubicación del edificio con respecto a aspectos como viento, sismos, cercanía al mar o altitud significativa).

Emilgroup diseña y desarrolla varios sistemas de Pared Ventilada y Fachada Aislada Ventilada capaces de satisfacer las más diversas exigencias estéticas y de proyecto.

ВЕНТИЛИРУЕМЫЙ ФАСАД

Вентилируемый фасад (или вентилируемая стена) - это особый тип наружной облицовки стен, предусматривающий сухую установку на наружные поверхности здания панелей необходимой толщины, которые не прилегают к стенам и отстоят от них на расстоянии, образуя тем самым воздушную камеру. Таким образом, под воздействием конвекции и при наличии проемов в нижней и в верхней части фасада обеспечивается естественная циркуляция воздуха в воздушной камере. Эти фасады создают термический и звуковой комфорт в помещениях и определяют архитектуру наружного окружения, в котором они находятся.

Инженерный отдел Emilgroup - это подразделение, обеспечивающее всеобъемлющую поддержку клиенту в проектировании, установке и сертификации систем облицовки внутренних и наружных поверхностей. Используя индивидуальный подход, инженерный отдел гарантирует безопасность и долговечность выполненных работ и наивысший контроль внутренних факторов (дизайн и морфология здания) и наружных (расположение здания по отношению к преобладающим ветрам, сейсмичность, близость к морю или большая высота над уровнем моря).

Emilgroup проектирует и разрабатывает различные системы вентилируемых фасадов и изолированных вентилируемых фасадов, которые способны удовлетворять самые разнообразные стилистические и проектные потребности.

PROGETTAZIONE E GESTIONE DEL CANTIERE

Tecnici qualificati e specializzati curano la progettazione esecutiva delle facciate, predisponendo:

- lay-out facciata
- sviluppo dei dettagli costruttivi (compresi raccordi angolo, serramenti, partenze e arrivi)
- redazione esecutivi di montaggio
- relazione di calcolo specifica per il cantiere in ottemperanza alle normative tecniche
- redazioni di as-built in corso d'opera per verifica corretto montaggio
- certificato di idoneità statica
- piano di manutenzione

Montatori qualificati e certificati realizzano la facciata garantendo qualità e durata.



A
Render
Rendu
Rendu
Rendering
Imagen digital
Рендер

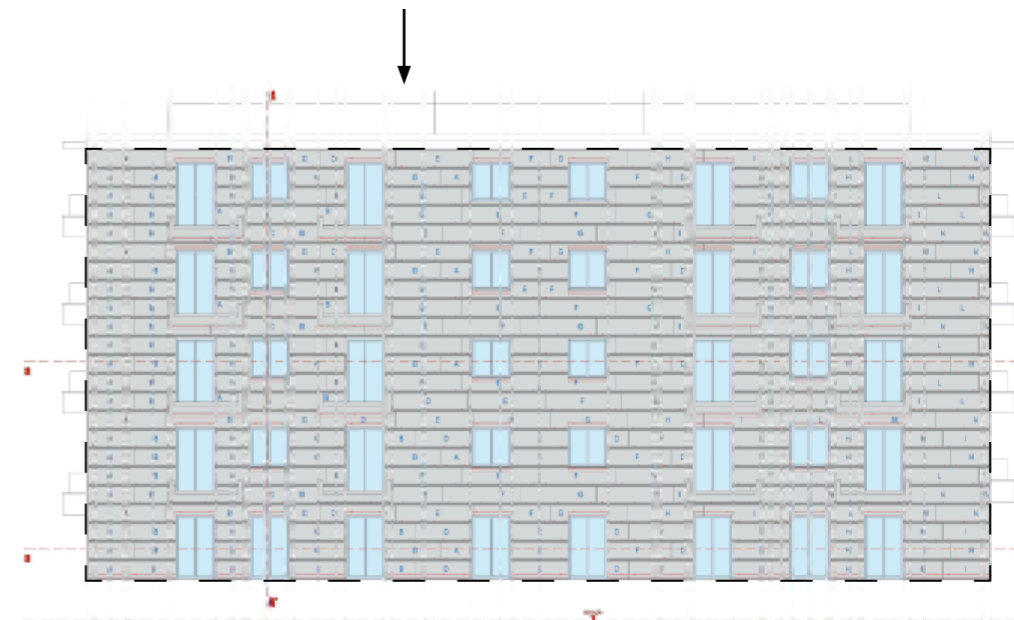

B
Progettazione strutturale
Structural design
Conception de la structure
Tragwerksplanung
Proyección estructural
Структурное проектирование



C
Progettazione architettonica
Architectural design
Projet architectural
Architekturplanung
Proyección arquitectónica
Архитектурное проектирование

DESIGN AND INSTALLATION MANAGEMENT

Skilled, specialised technical staff handle the executive design of facades, preparing:

- facade layout
- development of construction details (including corner connections, doors and windows and ends)
- working drawings for installation
- specific installation calculations to comply with technical regulations
- as-built reports while work is in progress to verify correct installation
- certificate of static suitability
- maintenance plan

Skilled, certified fitters construct the facade with quality and durability guaranteed.

ÉTUDE DE PROJET ET GESTION DU CHANTIER

Des techniciens qualifiés et spécialisés réalisent le projet d'exécution des façades:

- plan de la façade
- mise au point des détails de construction (y compris raccords d'angle, portes et fenêtres, départs et arrivées)
- rédaction des plans de montage
- note de calcul spécifique au chantier conformément aux réglementations techniques
- rédaction du plan de situation pendant le chantier pour contrôler le montage
- certificat de conformité de charge statique
- programme d'entretien

Des monteurs qualifiés et certifiés se chargent du montage de la façade pour garantir qualité et durabilité.

PLANUNG UND BAUSTELLENMANAGEMENT

Hochqualifizierte Spezialisten übernehmen die Ausführungsplanung der Fassaden, einschließlich:

- Fassadenlayout
- Bauteilkonstruktion (Eckverbindungen, Tür- und Fensteröffnungen, Fußpunkt und Dachrand)
- Montagepläne
- Berechnungsbericht für die Baustelle in Übereinstimmung mit den technischen Vorschriften
- As-Built-Dokumentation zur Prüfung der ordnungsgemäßen Montage
- Eignungsnachweis für statische Bauwerke
- Instandhaltungsplan

Die Installation der Fassade durch zertifizierte Fachmonteure gewährleistet hohe Qualität und eine lange Lebensdauer.

PROYECCIÓN Y GESTIÓN DE LAS OBRAS

Unos técnicos cualificados y especializados se encargan de la proyección ejecutiva de las fachadas, preparando:

- plano de la fachada
- desarrollo de los detalles constructivos (incluidos conductos angulares, cierres, puntos iniciales y terminales)
- redacción de detalles ejecutivos de montaje
- informe de cálculo específico para la obra en cumplimiento de las normas técnicas
- realización de planos de modificaciones constructivas durante la ejecución de la obra para el control de la correcta instalación
- certificado de idoneidad estática
- plan de mantenimiento

Montadores cualificados y dotados de certificación instalan la fachada garantizando calidad y durabilidad.

ПРОЕКТИРОВАНИЕ И УПРАВЛЕНИЕ СТРОИТЕЛЬСТВОМ

Квалифицированные и специализированные инженеры осуществляют исполнительное проектирование фасадов, готовя:

- планиметрию фасада
- разработку деталей конструкции (включая угловые соединения, дверные и оконные блоки, начало облицовки и ее завершение)
- составление исполнительных чертежей для монтажа
- специальные расчеты для строительства, выполняя требования технических норм
- составление отчета о ходе выполнения работ для проверки правильности монтажа
- сертификат статического соответствия
- план обслуживания

Квалифицированные и сертифицированные установщики изготавливают фасад, гарантируя качество и долговечность.

I SISTEMI: PARETE VENTILATA E FACCIATA ISOLATA VENTILATA

Emilgroup progetta e sviluppa i diversi sistemi in grado di soddisfare le più svariate esigenze stilistiche e progettuali:

- Parete ventilata
- Facciata isolata ventilata

Alla loro realizzazione collaborano aziende leader nei propri settori di riferimento fornendo un fondamentale contributo in termini di expertise e affidabilità. A seguito di accuratissime fasi di progettazione e test, le soluzioni si caratterizzano per una estrema semplicità di montaggio e si collocano al top della categoria dal punto di vista qualitativo e delle performance estetiche e funzionali.

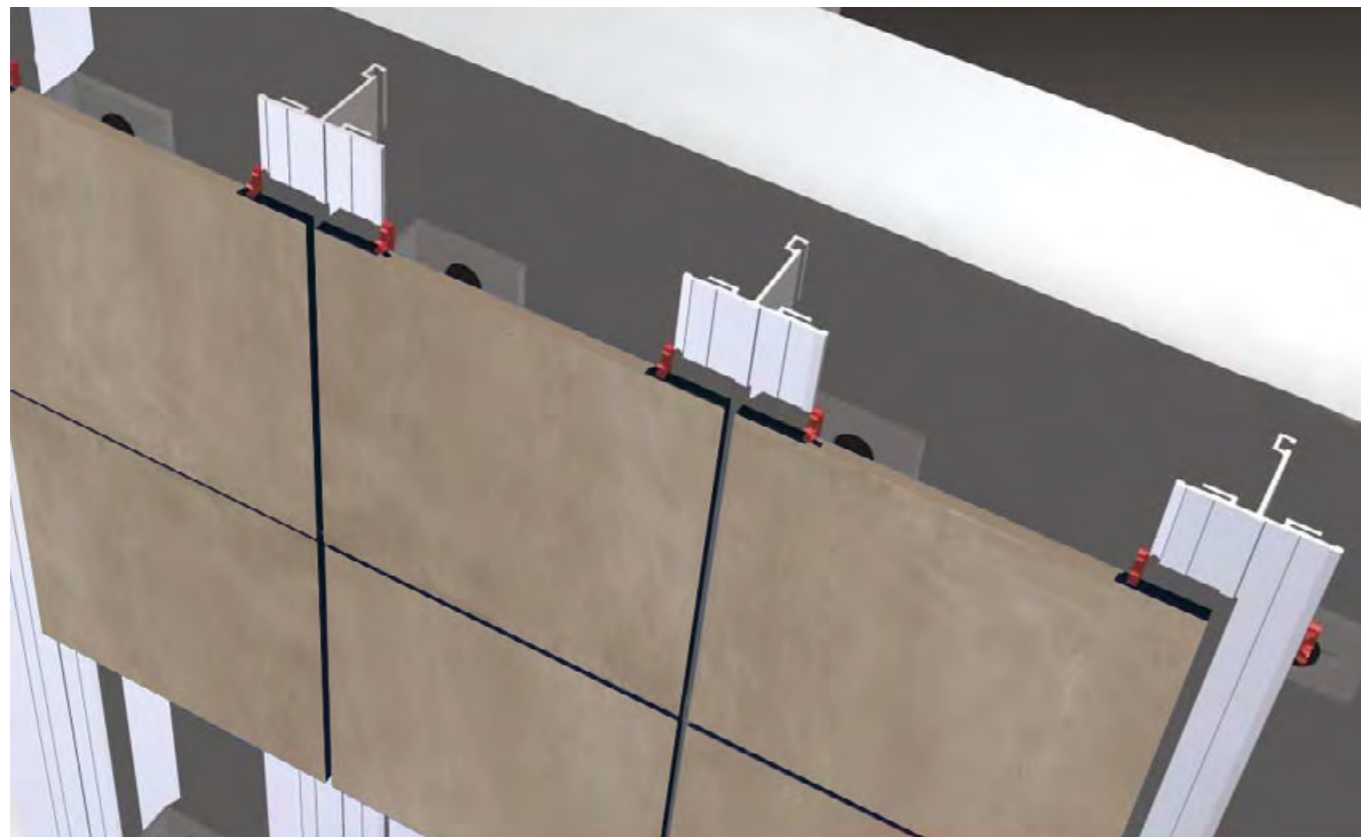

SYSTEMS: VENTILATED FAÇADE AND VENTILATED INSULATED FAÇADE

Emilgroup designs and develops various systems capable of satisfying the most widely varying stylistic and architectural needs:

- Ventilated facade
- Ventilated insulated facade

These systems are constructed in association with companies which are leaders in their individual fields, with invaluable inputs in terms of expertise and reliability. Further to meticulous design and testing phases, solutions are extremely easy to install and are at the top of their class in terms of quality and aesthetic and functional performances.

LES SYSTÈMES : FAÇADE VENTILÉE ET FAÇADE ISOLÉE VENTILÉE

Emilgroup conçoit et réalise des systèmes qui répondent aux exigences stylistiques et conceptuelles les plus disparates :

- Façade ventilée
- Façade isolée ventilée

Des entreprises leaders dans leur propre secteur de référence collaborent à leur réalisation, en apportant une assistance fondamentale en termes de compétence technique et de fiabilité. Après une étude de projet minutieuse et des essais approfondis, les solutions se distinguent par une extraordinaire simplicité de montage, et elles représentent ce qui se fait de mieux au niveau de la qualité, de l'esthétique et de la fonctionnalité.

SYSTEME: VORGEHÄNGTE HINTERLÜFTETE FASSADEN UND HINTERLÜFTETE GEDÄMMTE FASSADEN

Die Emilgroup plant und entwickelt Systeme, die verschiedensten Stil- und Projektanforderungen gerecht werden:

- Vorgehängte hinterlüftete Fassaden (VHF)
- Hinterlüftete gedämmte Fassaden

An der Umsetzung sind marktführende Spezialisten der jeweiligen Branchen beteiligt, die einen grundlegenden Beitrag in puncto Knowhow und Qualität leisten. Alle Lösungen werden nach strengen Kriterien geplant und geprüft. Sie zeichnen sich durch eine einfache Installation aus und setzen in Hinsicht auf Qualität, Ästhetik und Funktionalität Spitzenstandards in ihrem Bereich.

SISTEMAS: FACHADA VENTILADA Y FACHADA AISLADA VENTILADA

Emilgroup proyecta y desarrolla varios sistemas capaces de satisfacer las más diversas exigencias estilísticas y proyectivas:

- Fachada ventilada
- Fachada aislada ventilada

En su realización colaboran empresas punteras en sus sectores de referencia proporcionando una contribución fundamental en términos de pericia y fiabilidad. Fruto de una esmerada labor proyectiva avalada por rigurosas pruebas, las soluciones se caracterizan por una extraordinaria sencillez de montaje y se sitúan en lo más alto de la categoría desde el punto de vista cualitativo y de las prestaciones estéticas y funcionales.

СИСТЕМЫ: ВЕНТИЛИРУЕМЫЙ ФАСАД И ИЗОЛИРОВАННЫЙ ВЕНТИЛИРУЕМЫЙ ФАСАД

Emilgroup проектирует и разрабатывает различные системы, способные удовлетворять самые разнообразные стилистические и проектные потребности:

- Вентилируемый фасад
- Изолированный вентиляруемый фасад

В их реализации сотрудничают компании-лидеры в своих отраслях, внося определяющий вклад в плане компетенции и надежности. После самых тщательных этапов проектирования и тестирования решения характеризуются чрезвычайной простотой монтажа и занимают топовые позиции в этой категории по качеству, эстетическим и функциональным характеристикам.

PARETE VENTILATA

Il sistema è costituito da profili in alluminio a T adeguatamente fissati alla parete esistente dell'edificio tramite staffe e tasselli. La tipologia e il dimensionamento dei profili può essere opportunamente personalizzato in base alle esigenze e alle caratteristiche dell'edificio da rivestire.

Un'ampia possibilità di regolazioni permette a questo sistema di adattarsi a qualsiasi conformazione di facciata, anche a quelle architettonicamente più complesse e di risolvere eventuali problematiche di fuori piombo della parete, anche su edifici molto alti.

Al fine di garantire l'isolamento termico si procede con la posa di materiali isolanti adeguati. Completano il sistema elementi di raccordo con serramenti e balconi.

Il rivestimento costituito dalle lastre in gres Emilgroup viene successivamente ancorato ai profili tramite ganci in acciaio armonico studiati per permettere la massima garanzia di tenuta e al contempo la possibilità di resistere alle sollecitazioni quali carichi del vento e movimenti della struttura.

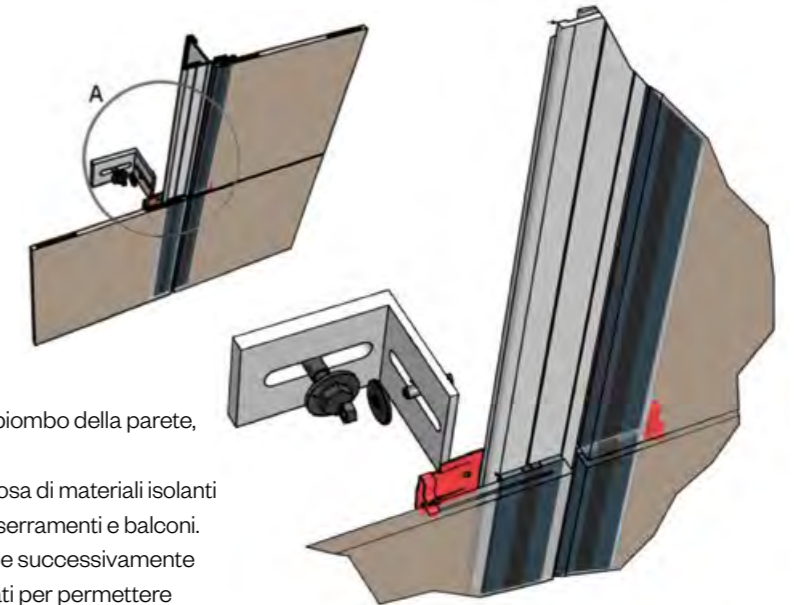

VENTILATED FAÇADE

The system consists of aluminium T-profiles, mounted on the building's existing wall using brackets and anchor bolts. The profile's type and size can be customised to requirements and the characteristics of the building for surface. A wide adjustment range enables this system to adapt to even the most architecturally complex facade and overcome any problems with non-perpendicular walls, even on very tall buildings. Thermal insulation is ensured by installing suitable insulation materials. The system is completed by elements which connect to doors, windows and balconies. The Emilgroup stoneware slab surface is then anchored to the profiles using harmonic steel hooks, developed to provide the firmest possible connection and also withstand stresses such as wind loads and structural shifting.

FAÇADE VENTILÉE

Le système se compose de profilés en T en aluminium solidarisés au gros-œuvre par des agrafes et par des chevilles. Le dimensionnement des profilés et leur nature peuvent être personnalisés selon les exigences et selon les caractéristiques du bâtiment. Très malléable, ce système s'adapte à n'importe quelle configuration de façade, y compris celles présentant une architecture plus complexe, et il permet de remédier aux éventuels écarts d'aplomb, y compris sur les bâtiments très hauts. Des matériaux isolants sont posés pour garantir le calorifugeage. Le système comprend aussi les éléments de raccord avec les portes, les fenêtres et les balcons. Les plaques en grès Emilgroup sont ensuite ancrées dans les profilés par des clips en acier à ressort, conçus non seulement pour sécuriser la fixation, mais aussi pour résister aux contraintes, comme la force du vent et les mouvements de la structure.

VORGEHÄNGTE HINTERLÜFTETE FASSADE

Das System besteht aus T-förmigen Aluminiumprofilen, die an der Außenwand des Gebäudes mit Konsolen und Dübeln befestigt werden. Form und Dimensionierung der Profile sind spezifisch auf die Anforderungen und Gegebenheiten des zu verkleidenden Gebäudes auslegbar. Aufgrund der zahlreichen Justiermöglichkeiten kann das System auf alle, auch komplexe Fassadenformen abgestimmt werden und etwaige Lotabweichungen der Wand, selbst bei hohen Gebäuden, ausgleichen. Geeignete Dämmstoffe gewährleisten die Wärmedämmung. Abgerundet wird das System durch Ergänzungsstücke für Türen, Fenster und Balkons.

Die Fassadenbekleidung aus Feinsteinzeugplatten der Emilgroup wird an den Profilen der Unterkonstruktion mit Hilfe von Ankern aus Federstahl befestigt, die höchste Dichtigkeit und zugleich Widerstandsfähigkeit gegenüber Windlasten und Bewegungen der Unterkonstruktion gewährleisten.

FACHADA VENTILADA

El sistema está constituido por perfiles de aluminio en forma de T oportunamente anclados a la pared existente del edificio por medio de elementos de fijación y tacos. El tipo y el tamaño de los perfiles se puede personalizar oportunamente en función de las necesidades y características del edificio que se vaya a revestir. La posibilidad de aplicar un amplio abanico de regulaciones hace que este sistema se pueda adaptar a fachadas con conformaciones de lo más diversas, incluidas las arquitectónicamente más complejas, y resolver eventuales dificultades ante paredes fuera de plomo, aun en edificios muy altos. Con el fin de garantizar el aislamiento térmico se colocan materiales aislantes adecuados. Completan el sistema elementos de conexión con puertas, ventanas y balcones.

A continuación el revestimiento constituido por las placas de gres de Emilgroup se ancla a los perfiles por medio de ganchos de acero armónico estudiados para asegurar la máxima sujeción y al mismo tiempo la máxima resistencia frente a cargas de viento y movimientos de la estructura.

ВЕНТИЛИРУЕМЫЙ ФАСАД

Система состоит из T-образных алюминиевых профилей, закрепленных на существующей стене здания при помощи кронштейнов и дюбелей. Тип и размеры профилей могут соответствовать индивидуальным требованиям, зависящим от потребностей и от характеристик облицовываемого здания. Широкие возможности регулировки позволяют этой системе адаптироваться к любой форме фасада, даже к самой сложной с архитектурной точки зрения, и решать проблемы неперпендикулярности стен, даже у очень высоких зданий. Для обеспечения теплоизоляции осуществляется укладка соответствующих изолирующих материалов. Дополняют систему элементы соединения с дверными и оконными блоками, а также с балконами.

Облицовка, состоящая из керамогранитных плит Emilgroup, фиксируется на профилях креплениями из пружинной стали, разработанными таким образом, чтобы обеспечивать наивысшую надежность и вместе с тем возможность выдерживать такие нагрузки, как ветровые и подвижки всей конструкции.

FACCIALE ISOLATA VENTILATA

Isotec Parete® è un sistema termoisolante che consente di comporre a secco un cappotto isolante e strutturale, per la realizzazione di facciate ventilate. Tale pannello, in un'unica soluzione tecnica, crea un cappotto esterno termoisolante continuo e omogeneo e una struttura di supporto per la finitura esterna di rivestimento.

Il correntino portante, integrato al pannello, forma una camera d'aria ventilata tra pannello isolante e finitura di facciata, in grado di rimuovere l'umidità dall'intercapedine ed asportare il calore in eccesso. Il pannello ha un'anima in poliuretano, dall'altissima prestazione isolante (conduttività termica dichiarata λ_D 0,022 W/mK), è estremamente semplice e veloce da posare. Il pannello può essere fissato sia in orizzontale che in verticale, a seconda del formato della lastra gres Emilgroup, che verrà successivamente fissata al correntino mediante appositi morsetti in acciaio armonico. Il pannello è disponibile in diversi spessori, da 60 a 160 mm, per rispondere alle diverse esigenze termiche dell'edificio, in ottemperanza alle norme energetiche vigenti.



ISOTEC
PARETE

Brianza Plastica

VENTILATED INSULATED FAÇADE

Isotec Parete® is a thermal insulation system allowing the dry construction of a structural insulating jacket for the creation of ventilated facades. The panel creates a continuous, uniform external thermal insulation jacket and simultaneously a supporting structure for the outer finishing cladding. The supporting rail integral with the panel creates a ventilated air gap between the insulating panel and the outer finishing cladding, to remove moisture from the cavity and disperse surplus heat. The panel has a polyurethane core with extremely high insulating performance (rated thermal conductivity λ_D 0,022 W/mK), and is extremely quick and easy to install. The panel can be mounted either horizontal or vertical, depending on the size of the Emilgroup stoneware slab, which will then be anchored to the rail with special harmonic steel clamps. The panel is available in various thicknesses, from 60 to 160 mm, to meet the building's different thermal requirements, in compliance with the relevant energy regulations.

FAÇADE ISOLÉE VENTILÉE

Isotec Parete® est un système d'isolation thermique qui permet de composer, à sec, un mur manteau isolant et structurel pour la réalisation des façades ventilées. En une seule solution technique, ce panneau forme à la fois une enveloppe extérieure thermo-isolante continue et uniforme, et une structure de support pour la finition extérieure du revêtement. Le liteau intégré au panneau forme une lame d'air ventilée entre le panneau isolant et la finition, en mesure de supprimer l'humidité dans le vide technique et d'évacuer l'excès de chaleur. Le panneau a une âme en polyuréthane à haute performance thermique (conductivité thermique déclarée λ_D 0,022 W/mK). Sa pose est extrêmement simple et rapide. Le panneau peut être fixé à l'horizontale ou à la verticale, selon le format de la plaque en grès Emilgroup qui sera ensuite attachée au liteau par des clips spéciaux en acier à ressort. Le panneau est disponible en plusieurs épaisseurs, de 60 à 160 mm, pour répondre aux différentes exigences thermiques du bâtiment, conformément aux normes en vigueur en matière d'efficacité énergétique.

HINTERLÜFTETE, GEDÄMMTE FASSADEN

Isotec Parete® ist ein Dämmsystem, das im Trockenbau als Wärmedämm- und Tragverbundsystem für hinterlüftete Fassaden ausgeführt wird. Die Dämmplatte bildet als einschalige Lösung ein durchgängiges und homogenes Wärmedämmverbundsystem an der Außenwand und eine Tragkonstruktion für die Fassadenbekleidung. Das in die Dämmplatte integrierte Tragprofil sorgt für einen Hinterlüftungsspalt zwischen Dämmplatte und Fassadenbekleidung, aus dem Feuchtigkeit und Wärme abgeführt werden. Die Dämmplatte mit einem Dämmkern aus PU-Schaum (Wärmeleitfähigkeit λ_D 0,022 W/mK) kann einfach und zügig installiert werden. Die Dämmplatte ist sowohl hochkant als auch quer montierbar, entsprechend dem Format der Emilgroup-Feinsteinzeugplatte. Zum Schluss wird die Feinsteinzeugplatte mit Hilfe von Ankern aus Federstahl am Tragprofil befestigt. Die Dämmplatte ist in unterschiedlichen Dicken von 60 bis 160 mm je nach Dämmungsbedarf des Gebäudes und gemäß den geltenden Vorschriften zur Energieeinsparung erhältlich.

FACHADA AISLADA VENTILADA

Isotec Parete® es un sistema termoisolante que permite instalar en seco capas aislantes y estructurales para la realización de fachadas ventiladas. Este panel, en una única solución técnica, crea una capa exterior termoisolante continua y homogénea y una estructura de sostén para el acabado exterior de revestimiento. La vigueta de sostén, integrada en el panel, forma una cámara ventilada entre el panel aislante y el acabado de la fachada, capaz de eliminar el calor excesivo y la humedad del intersticio. El panel, que tiene una ánima de poliuretano de muy elevado poder aislante (conductividad térmica declarada λ_D 0,022 W/mK), se coloca de manera muy sencilla y rápida. El panel se puede fijar tanto en horizontal como en vertical, según el formato de la placa de gres de Emilgroup, que a continuación se sujetará a la vigueta mediante mordazas de acero armónico. El panel se halla disponible en varios grosores, de 60 a 160 mm, para responder a las diversas exigencias térmicas de los edificios, en cumplimiento de las normas energéticas vigentes.

ИЗОЛИРОВАННЫЙ ВЕНТИЛИРУЕМЫЙ ФАСАД

Isotec Parete® - это теплоизолирующая система, позволяющая изготовлять сухим способом изолирующую и несущую облицовку для установки вентилируемого фасада. Эта панель единым техническим решением создает сплошную и однородную теплоизолирующую наружную облицовку и несущую конструкцию для наружной отделки. Встроенный в панель несущий профиль образует вентилируемую воздушную камеру между изолирующей панелью и отделкой фасада, способную отводить влагу из воздушной камеры и избыточное тепло. Панель имеет полиуретановую сердцевину с очень высокой изолирующей способностью (заявленная теплопроводность - λ_D 0,022 W/mK) и очень просто и быстро устанавливается. Панель можно крепить как горизонтально, так и вертикально, в зависимости от формата керамогранитной плиты Emilgroup, которая затем будет зафиксирована на профиле специальными креплениями из пружинящей стали. Панель может иметь разную толщину, от 60 до 160 мм, чтобы отвечать на различные теплоизоляционные потребности здания, выполняя действующие энергетические стандарты.

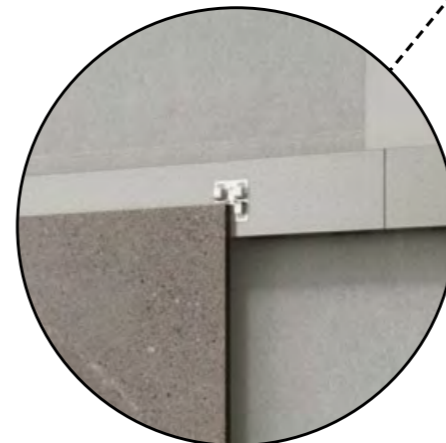
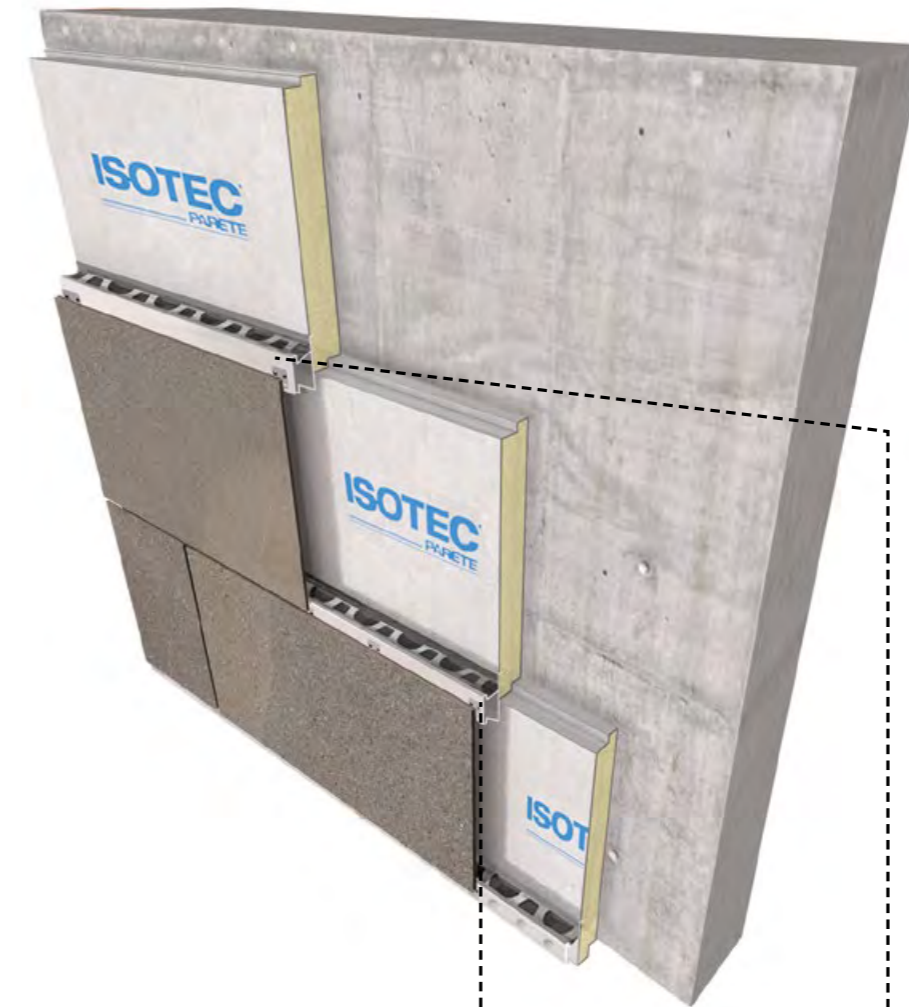

GLI AGGANCI

La facciate ventilate proposte da Emilgroup sono pensate per soddisfare le più svariate esigenze stilistiche, funzionali e strutturali espresse da progettisti, architetti e designer. Per riuscire in questo scopo, sono stati concepiti tre specifici sistemi di aggancio, adatti alla realizzazione di diversi tipi di soluzioni.

- SISTEMA A VISTA
- SISTEMA A SCOMPARSA
- SISTEMA INCOLLATO

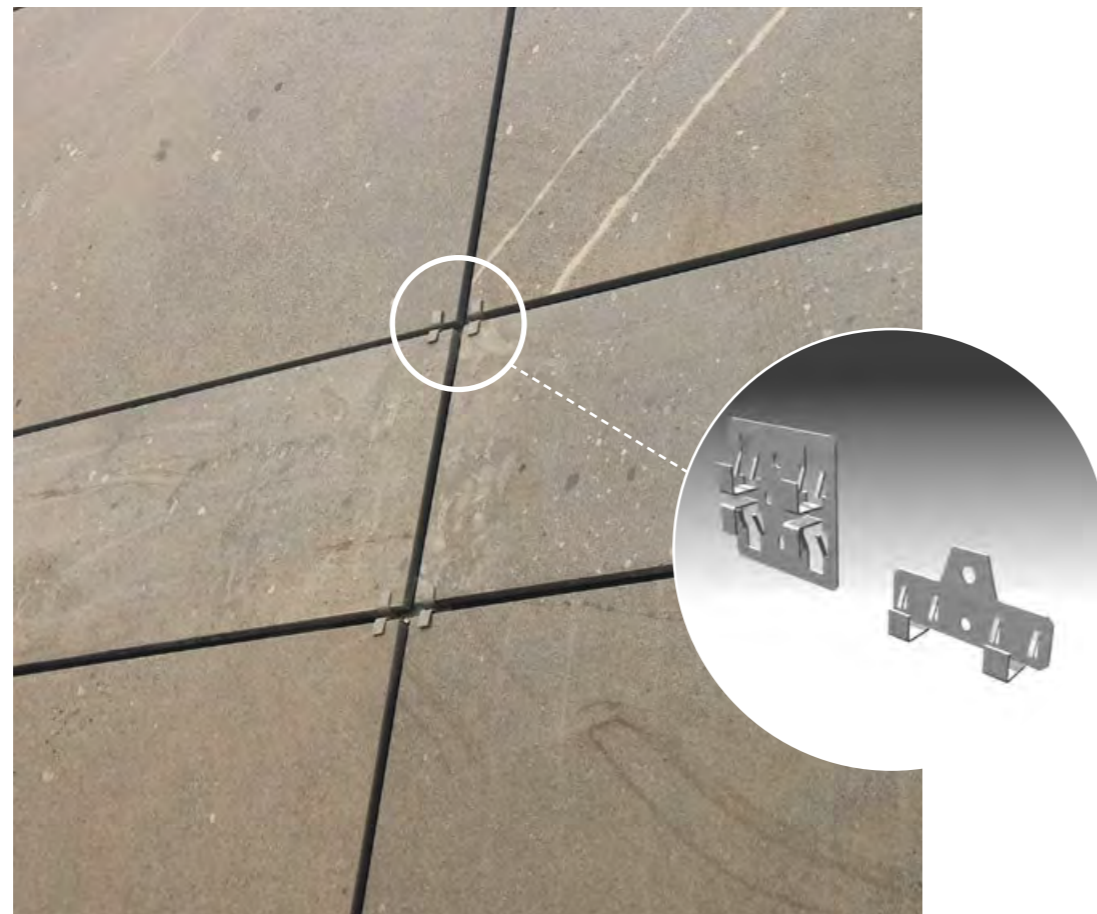

SISTEMA A VISTA
Visible anchor system
Système apparent
Sichtbare Befestigung
Sistema a la vista
Наружная система



SISTEMA A SCOMPARSA
Hidden anchor system
Système non apparent
Unsichtbare Befestigung
Sistema oculto
Скрытая система

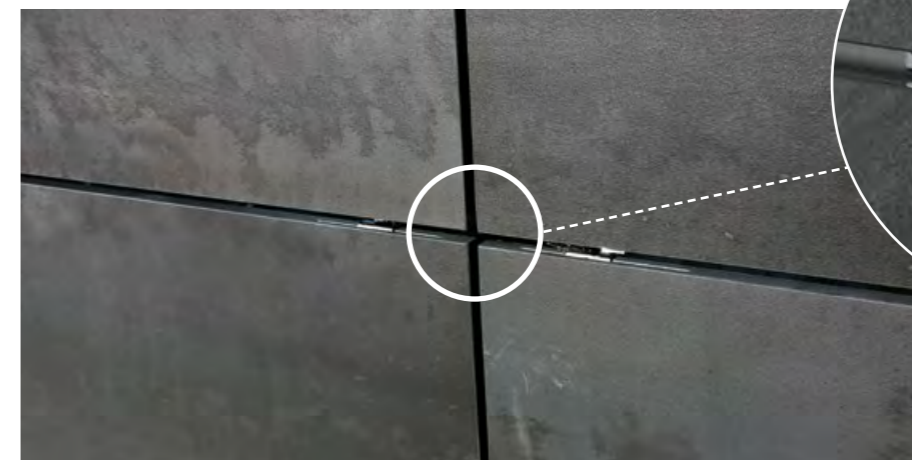

SISTEMA INCOLLATO
Glued anchor system
Système collé
Befestigung durch Klebung
Sistema encolado
Наклеиваемая система

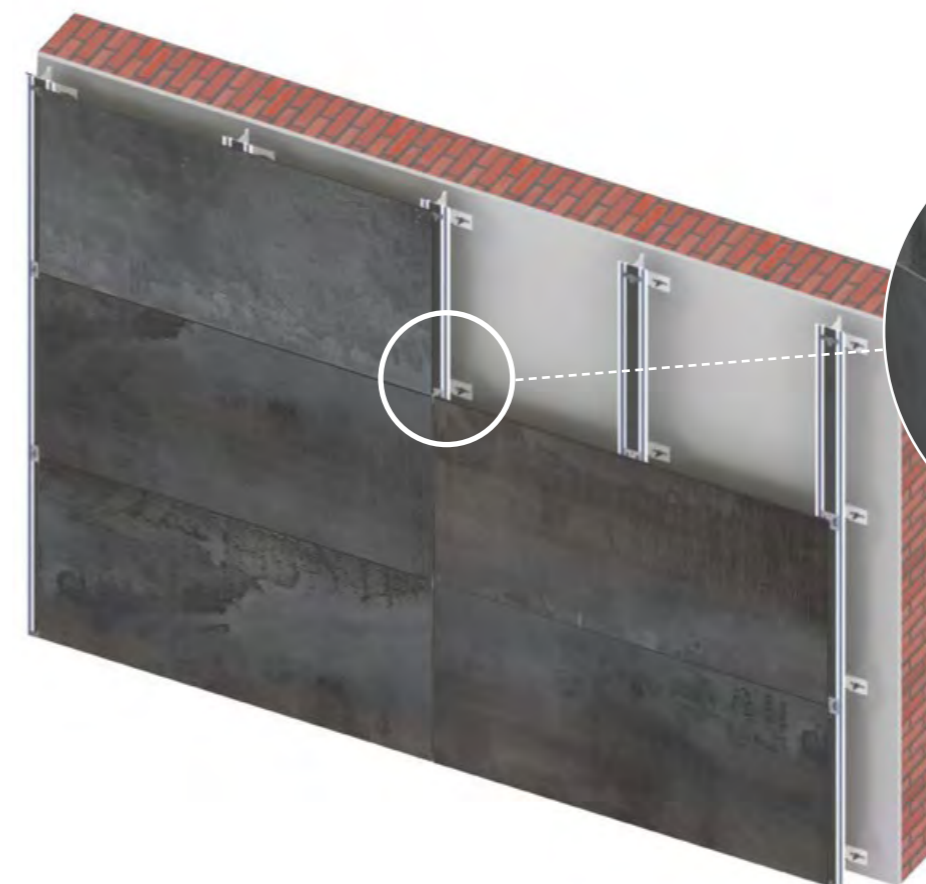

MOUNTING FIXTURES

Emilgroup ventilated facades are designed to cover all the various demands of engineers, architects and designers in terms of appearance, function and structure. This is achieved with aid of three specific anchor systems, allowing the realisation of different types of solutions.

- Visible anchor system
- Hidden anchor system
- Glued anchor system

LES ANCRAGES

Les façades ventilées Emilgroup sont conçues pour répondre aux exigences les plus disparates des concepteurs, architectes et designers en matière d'esthétique, de fonctionnalité et de structure. Trois systèmes d'ancrage ont été mis au point pour pouvoir se plier à tous les critères du projet.

- Système apparent
- Système non apparent
- Système collé

BEFESTIGUNGEN

Die vorgehängten hinterlüfteten Fassaden der Emilgroup sind für die verschiedensten Stil-, Funktions- und Tragwerkanforderungen von Planern, Architekten und Designern konzipiert. Hierzu wurden drei Befestigungssysteme für unterschiedliche Lösungen entwickelt.

- Sichtbare Befestigung
- Unsichtbare Befestigung
- Befestigung durch Klebung

ANCLAJES

Las fachadas ventiladas propuestas por Emilgroup están pensadas para satisfacer las más diversas exigencias estilísticas, funcionales y estructurales expresadas por proyectistas, arquitectos y diseñadores. Para alcanzar este objetivo se han concebido tres sistemas de anclaje, adecuados para la realización de varios tipos de soluciones.

- Sistema a la vista
- Sistema oculto
- Sistema encolado

КРЕПЛЕНИЯ

Предлагаемые Emilgroup вентилируемые фасады разработаны для удовлетворения самых разнообразных стилистических, функциональных и структурных потребностей, выдвигаемых проектировщиками, архитекторами и дизайнерами. Для этого были разработаны три специальные системы крепления, пригодные для реализации решений разного типа.

- Наружная система
- Скрытая система
- Наклеиваемая система



PAVIMENTI SOPRAELEVATI



PAVIMENTI SOPRAELEVATI INTERNI

Il pavimento sopraelevato è nato per conciliare due caratteristiche degli edifici che, con le soluzioni fin qui utilizzate, sono in contraddizione fra di loro: quella dell'immutabilità delle strutture murarie e, di contro, la flessibilità ed intercambiabilità che dovrebbero avere i vari impianti, problema molto sentito soprattutto in uffici, banche, centri di calcolo etc. L'aggiunta imprevista o lo spostamento di un posto di lavoro, lo spostamento di un punto luce o di un telefono creava una serie di problemi che si risolvevano con una serie di disagi e costi abbastanza elevati. Il pavimento sopraelevato risolve definitivamente qualsiasi problema di spostamenti, manutenzioni e aggiunte senza creare problemi, riducendo drasticamente i tempi di intervento, diventando così in breve tempo più economico rispetto ad un pavimento tradizionale.

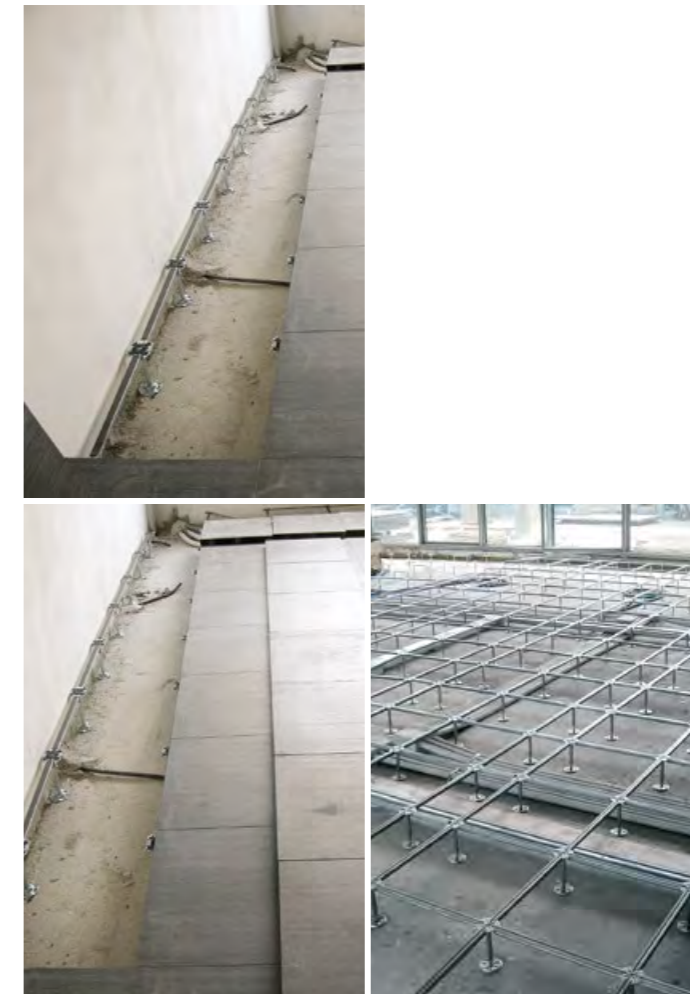

INDOOR CAVITY FLOORS

Cavity floors resolve two requirements of buildings which are otherwise mutually exclusive: unchangeable building structures and, on the other hand, flexibility and interchangeability of plant - an essential requirement particularly in offices, banks, data centres, etc. Unexpectedly adding or removing a work station, moving a power socket or phone connection can create problems which are troublesome and costly to solve. Cavity floors solve problems of maintenance, movement and adding/removing infrastructure once and for all, and are thus soon more cost effective than conventional flooring solutions.

PLANCHERS SURÉLEVÉS INTÉRIEURS

Le plancher surélevé sert à concilier deux caractéristiques du bâtiment que les solutions actuelles continuent à placer en antagonisme : d'une part l'immuabilité de la grosse maçonnerie, de l'autre la flexibilité et l'interchangeabilité que devraient avoir les différents équipements. Il s'agit là d'un problème très fréquent, notamment dans les bureaux, les banques, les centres de traitement de données etc. L'ajout soudain ou le déplacement d'un poste de travail, le déplacement d'un luminaire ou d'un téléphone posaient toute une série de problèmes qui entraînaient beaucoup d'inconvénients et des frais significatifs. Le plancher surélevé apporte une solution définitive à tous les problèmes de déplacement, de maintenance et d'ajout en abrégant énormément les délais d'intervention et en devenant ainsi, en peu de temps, plus économique qu'un plancher traditionnel.

DOPPELBÖDEN FÜR INNENRÄUME

Mit Doppelböden gelingt es, bestimmte Eigenschaften zu vereinen, die in technischer Hinsicht bisher gegensätzlich waren: einerseits die Unveränderlichkeit von Mauerwerk und andererseits die bei den verschiedenen technischen Anlagen erforderliche Flexibilität und Austauschbarkeit. Dieses Problem stellte sich vor allem in Büros, Banken, Rechenzentren usw., wo das Hinzufügen oder Verlegen eines Arbeitsplatzes, das Versetzen einer Lampe oder eines Telefons häufig mit großem Aufwand und relativ hohen Kosten verbunden war. Ein Doppelboden erlaubt problemloses Versetzen, Hinzufügen und Instandhalten und reduziert erheblich den dafür erforderlichen zeitlichen Aufwand. Deshalb erweist sich ein solches System im Vergleich zu einem herkömmlichen Bodenbelag innerhalb kurzer Zeit als wesentlich wirtschaftlicher.

PAVIMENTOS SOBREELEVADOS INTERIORES

El pavimento sobreelevado nació para compatibilizar dos características de los edificios que, con las soluciones aplicadas hasta ahora, estaban en contradicción: por una parte la inmutabilidad de las estructuras de las paredes y por la otra la flexibilidad y la versatilidad que deberían tener las varias instalaciones, problema muy frecuente en oficinas, bancos, centros de cálculo, etc. La añadidura imprevista o el desplazamiento de un lugar de trabajo, así como el desplazamiento de un punto de luz o de un teléfono creaban problemas que se resolvían con una serie de incomodidades considerables y con costes bastante altos. El pavimento sobreelevado soluciona definitivamente toda dificultad relacionada con desplazamientos, intervenciones de mantenimiento y añadidura de puestos de trabajo sin crear problemas y reduciendo drásticamente la duración de la intervención. Como consecuencia de todo ello, el pavimento sobreelevado en poco tiempo acaba por resultar más económico que el suelo tradicional.

ФАЛЬШПОЛЫ ДЛЯ ПОМЕЩЕНИЙ

Фальшпол появился на свет для удовлетворения двух характеристик зданий, которые при использовании традиционных решений противоречат друг другу: неизменность конструкций здания, с одной стороны, а с другой - гибкость и взаимозаменяемость, которыми должны обладать различные системы, что очень важно, в особенности в офисах, банках, вычислительных центрах и т.д. Непредусмотренное расширение и перенос рабочего места, перенос светильника или же телефона создавал ряд проблем, которые приводили к различным неудобствам и довольно высоким затратам. Фальшпол окончательно решает любую проблему, связанную с переносом, обслуживанием и расширением, не вызывая неудобств, резко снижая время на выполнение работ, в кратчайшие сроки становясь более экономичным, чем традиционный пол.

PANNELLI PER PAVIMENTI SOPRAELEVATI

Tecnicamente, il pavimento sopraelevato è formato da pannelli, di dimensione 60x60, bordati e fugati, che poggiano su una struttura di acciaio ad altezza variabile, la quale forma una sorta di "spazio tecnico nascosto", sempre disponibile, nel quale alloggiare impianti elettrici, tubature, cavi telefonici, aria condizionata, riscaldamento e qualsiasi altro servizio.

Ogni pannello è semplicemente appoggiato, per cui il pavimento è ispezionabile in qualsiasi punto sollevando semplicemente i pannelli. I collegamenti degli impianti con i locali sono realizzati mediante fori e relative torrette, griglie per il passaggio di aria. Si possono realizzare gradini singoli o multipli, rampe, battute di tamponamento. L'altezza minima del pavimento finito, rispetto al piano di appoggio, è di 7/8 centimetri circa, per cui la soluzione del pavimento sopraelevato è solitamente praticabile anche nel caso di sovrapposizione su pavimentazioni esistenti.

PANNELLI PER PAVIMENTI SOPRAELEVATI

Technically, cavity floors are formed of 60x60 grouted and bordered panels resting on a variable height steel frame, which forms a concealed technical space, always available for housing electrical systems, tubing, phone cables, air conditioning and heating equipment and any other type of service. Each panel is simply resting on the frame, and can be lifted up at any time to inspect the underlying cavity at any point. The connections of the plant with the rooms is via holes, terminals, and air grilles. Single and multiple steps can be built, as can ramps and stoppers. The minimum height of the finished floor over the supporting surface is around 7/8 centimetres, so that the cavity floor solution is perfectly practical even if installed over existing flooring.

PANNEAUX POUR PLANCHERS SURÉLEVÉS

Au point de vue technique, le plancher surélevé se compose de panneaux 60x60 cm avec bords et joints, posés sur une structure en acier de hauteur variable qui, à son tour, forme une sorte de « vide technique caché », toujours disponible, dans lequel dissimuler le matériel électrique, les canalisations, les câbles de téléphone, la climatisation, le chauffage et tout autre équipement. Déposé tout simplement sur la structure, chaque panneau se retire facilement pour que le plancher soit contrôlable à n'importe quel endroit. Les connexions entre l'équipement sous-jacent et les locaux se font par des boîtes de sol et passe-câbles, et par les grilles d'aération. Il est possible de réaliser des marches simples ou multiples, des rampes, des jouées d'arrêt. La hauteur du plancher fini, par rapport à la surface d'appui, est d'environ 7/8 centimètres. Le plancher surélevé est, par conséquent, également une solution parfaitement adaptée en cas de superposition sur planchers existants.

PLATTEN FÜR DOPPELBÖDEN

Technisch gesehen besteht ein Doppelboden aus Platten in der Größe 60x60 cm mit Rand und Fuge, die auf einer Stahltragstruktur in unterschiedlicher Höhe aufliegen. Dadurch entsteht ein jederzeit zugänglicher „Technikraum“, in dem elektrische Anlagen, Rohrleitungen, Telefonkabel, Klimaanlage- und Heizungselemente und jegliche sonstigen technischen Anlagen untergebracht werden können. Jede Platte ist nur aufgelegt. Der Bodenbelag ist daher leicht an jedem Punkt inspektionierbar, denn die Platten können einfach angehoben werden. Die Anlagenanschlüsse in den Räumen erfolgen mithilfe von Bohrlochern und entsprechenden Stützlagern und es werden Lüftungsgitter vorgesehen. Es besteht die Möglichkeit zur Herstellung einzelner oder mehrerer Treppenplatten, Rampen und Raumabschlüssen. Die Mindesthöhe für den fertigen Bodenbelag beträgt in Bezug auf die Auflagefläche ca. 7-8 cm. Deshalb kann ein Doppelboden in der Regel auch auf bereits vorhandenen Bodenbelägen montiert werden.

PANELES PARA PAVIMENTOS SOBREELEVADOS

Técnicamente, el pavimento sobreelevado está formado por paneles de 60 x 60 cm, dotados de bordes y juntas, que se apoyan sobre una estructura de acero de altura variable, para configurar una especie de "espacio técnico oculto", siempre disponible, en el que alojar instalaciones eléctricas, tuberías, cables telefónicos, conductos de aire acondicionado, calefacción y cualquier otro servicio. Los paneles se colocan dejándolos apoyados, por lo que el pavimento se puede inspeccionar en cualquier punto simplemente levantando la placa o las placas correspondientes. Los sistemas de agua, luz, gas, etc. se conectan con los locales mediante orificios y torretas, así como a través de rejillas para el paso del aire. Se pueden crear escalones sencillos o múltiples, rampas y paneles de cierre. La altura mínima del pavimento terminado, con respecto a la superficie de apoyo, es de unos siete u ocho centímetros, por lo que la solución del pavimento sobreelevado resulta factible casi siempre, incluso en los casos en los que se tenga que superponer a pavimentaciones ya existentes.

ПАНЕЛИ ДЛЯ ФАЛЬШПОЛОВ

С технической точки зрения фальшпол состоит из панелей размером 60x60 см с окантовкой и заделкой швов, которые держатся на стальной конструкции с изменяющейся высотой, образующей своего рода скрытое и всегда доступное технологическое пространство, в котором располагаются электрические системы, трубы, телефонные кабели, система кондиционирования, отопления и любые другие инженерные системы. Каждая панель просто уложена, поэтому, пол можно осматривать в любой точке, для чего нужно всего лишь поднять панели. Выводы систем в помещения осуществляются через отверстия и соответствующие возвышения или решетки для прохода воздуха. Можно изготавливать одиночные ступени или же лестницы, пандусы, закрывающие элементы. Минимальная высота готового пола по сравнению с опорной поверхностью составляет около 7-8 сантиметров, поэтому, настил фальшполов, как правило, может осуществляться также и при наличии старого пола.



MATERIALE CERAMICO

Ceramic material
Matériau céramique
Keramikbelag
Material cerámico
Керамический материал

STRATO LEGANTE

Binding layer
Couche liante
Bindeschicht
Capa adhesiva
Связующий слой

PANNELLO PORTANTE

Bearing panel
Panneau porteur
Trägerplatte
Panel de sostén
Несущая панель

BARRIERA ANTIVAPORE

(foglio di alluminio)
Vapour barrier (aluminium sheet)
Pare-vapeur (feuille d'aluminium)
Wasserdampfbarriere (aluminiumfolie)
Barrera antivapor (hoja de aluminio)
Парозащитный барьер (алюминиевый лист)

STRUTTURA DI SOSTEGNO IN ACCIAIO

Steel frame
Structure de support en acier
Stützkonstruktion aus stahl
Estructura de sostén de acero
Стальная опорная конструкция.



STRUTTURA PORTANTE

La struttura portante è costituita da piedini di altezza variabile da 3/4 cm ad oltre 1 metro. La parte superiore è formata da 4 oppure 8 razze alle quali incastrare e bloccare i traversi, sempre di acciaio, che servono per meglio appoggiare i pannelli, inoltre danno la misura precisa per il distanziamento dei piedini. Esistono varie sezioni dei traversi, inoltre è possibile, per aumentare la resistenza ai carichi del pavimento, inserire anche ulteriori traversi diagonali. La parte superiore dei piedini e dei traversi è bordata con gomma antistatica, avente la funzione di assorbire gli scricchiolii e le vibrazioni.



BEARING FRAME

The frame is composed of feet which can be adjusted from 3/4 cm to over 1 metre. The upper section is composed of 4 or 8 spokes which lock into the steel beams which in turn support the panels and precisely space the feet. There are a variety of beam sections, and diagonal beams can be added to increase the floor's load bearing capacity. The top of the feet and beams is bordered with anti-static rubber, which absorbs creaks and vibrations.

STRUCTURE PORTEUSE

La structure porteuse se compose de plots de hauteur variable, de 3/4 cm à plus de 1 mètre. La partie supérieure compte 4 ou 8 crans dans lesquels encastrer et bloquer les traverses, en acier également, qui servent à optimiser l'appui des panneaux, ainsi qu'à définir précisément l'espacement entre les plots. Il existe plusieurs types de traverses. Pour augmenter la résistance à la charge du plancher, des traverses diagonales peuvent aussi être ajoutées. La partie supérieure des plots et des traverses présente un bord en caoutchouc antistatique pour absorber les craquements et les vibrations.

TRAGKONSTRUKTION

Die Tragkonstruktion besteht aus Bodenstützen mit verstellbarer Höhe von 3/4 cm bis über 1 m. Der obere Bereich besteht aus 4 oder 8 Speichen, an denen die ebenfalls aus Stahl bestehenden Querträger fixiert werden. Auf die Querträger werden die Platten aufgelegt; sie geben zudem den Abstand für die Bodenstützen vor. Die Querträger sind mit unterschiedlichen Querschnitten erhältlich. Die Belastbarkeit des Bodenbelags kann durch Einsetzen weiterer, diagonaler Querträger zusätzlich erhöht werden. Der obere Bereich der Bodenstützen und Querträger hat einen Rand aus antistatischem Gummi, der zur Schall- und Vibrationsdämmung dient.

ESTRUCTURA DE SOSTÉN

La estructura de sostén está constituida por unos pies con una altura variable de tres o cuatro centímetros a más de un metro. La parte superior está formada por cuatro u ocho radios a los que encajar y fijar los travesaños, también de acero, que ayudan a formar una base sobre la que apoyar los paneles; además, brindan la medida exacta para el distanciamiento de los pies. Existen varias secciones de travesaños; además se puede aumentar la resistencia del pavimento a las cargas agregando más travesaños diagonales. La parte superior de los pies y de los travesaños está revestida a lo largo de los bordes con goma antiestática, que tiene la función de amortiguar y reducir rechinchamientos y vibraciones.

НЕСУЩАЯ КОНСТРУКЦИЯ

Несущая конструкция состоит из ножек высотой от 3-4 см до более 1 метра. Верхняя часть состоит из 4 или из 8 спиц, к которым крепятся и блокируются поперечины, также выполненные из стали, необходимые для лучшей укладки панелей. Кроме того, они задают точный размер для установки ножек. Поперечины могут иметь разное сечение, кроме того, для повышения выдерживаемой полом нагрузки можно установить дополнительные диагональные поперечины. Верхняя часть ножек и поперечин окантована антистатической резиной, задачей которой является устранение скрипа и вибрации.

PANNELLO PORTANTE

Il pannello portante è formato da una anima centrale di 3-4 cm che può essere di legno truciolare ad alta o altissima densità, oppure inerti e resine, che determina le caratteristiche di resistenza (ai carichi ed al fuoco) del pavimento. Tutti i tipi di pannello vengono bordati inferiormente con un foglio di alluminio che protegge dall'umidità e vengono bordati perimetralmente in gomma. Il materiale ceramico di finitura viene incollato, fugato e bordato intorno al pannello con resine poliuretaniche. Si possono utilizzare tutti i grandi formati (lo standard prevede la misura di 60 cm).

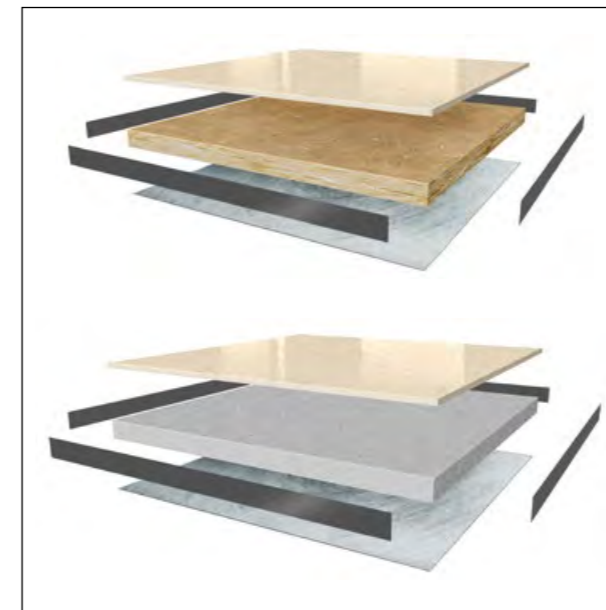

BEARING PANEL

The bearing panel is composed of core of 3-4 cm which can be made of high or very high density wood chipping, or aggregate and resin, and which determines the panel's mechanical strength and resistance to fire. All types of panels are bordered underneath with an aluminium sheet which protects against humidity and are bordered around their edges with rubber. The finishing ceramic layer is glued, grouted and bordered around the panel with polyurethane resin. All large formats are available (the standard one being 60 cm).

PANNEAU PORTEUR

Le panneau porteur se compose d'une âme centrale de 3-4 cm qui peut être en particules de bois à haute ou à très haute densité, ou en matériaux inertes et résines. Celle-ci détermine les caractéristiques de résistance (à la charge et au feu) du plancher. Quel qu'en soit le type, les panneaux comportent, dans le bas, un bord en feuille d'aluminium pour la protection contre l'humidité et, autour, un bord en caoutchouc. La matière céramique de finition est collée sur le panneau, jointoyée et entourée de résines polyuréthanes. Tous les grands formats peuvent être utilisés (mesure standard 60 cm).

TRÄGERPLATTE

Die Trägerplatte besteht aus einer 3-4 cm starken Spanplatte mit hoher oder sehr hoher Dichte oder aus Inertmaterial und Harz, welche die jeweiligen Festigkeitseigenschaften (Tragfähigkeit und Brandfestigkeit) des Bodenbelags bestimmt. Alle Trägerplattenarten werden an der Unterseite mit Aluminiumfolie versehen, die vor Feuchtigkeit schützt, und erhält eine Gummiumrandung an der Außenkante. Der Oberbelag aus Keramik wird an der Trägerplatte mit Polyurethanharzen verklebt, verfugt und mit einem Rand versehen. Sämtliche Großformate sind verwendbar (das Standardmaß sind 60 cm).

PANEL DE SOSTÉN

El panel de sostén está formado por un alma central de tres o cuatro centímetros, y es de conglomerado de alta o muy alta densidad o bien de materiales inertes y resinas, que determinan las características de resistencia (a las cargas y al fuego) del pavimento. Todos los tipos de panel presentan bordes revestidos con hoja de aluminio en su parte inferior, para protegerlos de la humedad, y con goma en su perímetro. El material cerámico de acabado es encolado, dotado de juntas y revestido a lo largo de su borde, alrededor de todo el panel, con resinas poliuretánicas. Se pueden utilizar todos los formatos grandes (el formato estándar mide 60 cm).

НЕСУЩАЯ ПАНЕЛЬ

Несущая панель состоит из сердечника толщиной 3-4 см, который может быть выполнен из ДСП высокой или очень высокой плотности, или же из наполнителей и смол, что определяет характеристики стойкости пола (к нагрузкам и огню). Панели всех типов покрываются снизу алюминиевой фольгой, которая защищает от влаги, а по периметру они окантовываются резиной. Отделочный керамический материал наклеивается, заделывается и герметизируется по периметру панели полиуретановой смолой. Можно использовать все большие форматы (стандартный размер - 60 см).

PAVIMENTI SOPRAELEVATI ESTERNI

Utilizzando lo spessore 20mm delle superfici Emilgroup, è possibile realizzare pavimentazioni sopraelevate in qualsiasi contesto di progettazione outdoor, operando in maniera semplice, veloce e sicura sulle strutture preesistenti, senza la necessità di effettuare interventi edilizi particolarmente onerosi. Essendo basate su sistemi modulari e regolabili, tali applicazioni permettono di realizzare pavimenti uniformi e stilisticamente ricercati che portano in dote numerosi vantaggi tecnici e logistici. Tra i principali:

- l'eliminazione dei problemi di umidità, infiltrazione di acqua e difficoltà di deflusso
- un migliore isolamento termico e acustico
- una elevata resistenza ai carichi e alle sollecitazioni
- una riduzione del peso della pavimentazione sulla struttura di appoggio
- un'ottima capacità di assorbimento delle dilatazioni e dei movimenti strutturali
- la creazione di un vano tecnico tra le superfici calpestabili e la struttura sottostante, per l'alloggiamento di cavi, tubi e altri tipi di impianti nascosti alla vista, ma al contempo facilmente ispezionabili ed eventualmente riparabili
- l'utilizzo di materiali completamente riusabili e riciclabili, nel massimo rispetto dei principi di circolarità e sostenibilità ambientale.



OUTDOOR CAVITY FLOORS

Emilgroup surfaces in the 20 mm thickness are the quick, easy, safe way of constructing raised pavings on top of existing surfaces in any outdoor location, with no need for particularly expensive building works. Since they are based on modular, adjustable systems, these applications can create uniform pavings of immaculate appearance, with a large number of technical and logistical benefits. Chief amongst them:

- elimination of damp, water infiltration and drainage problems
- improved heat insulation and soundproofing
- excellent resistance to loads and stresses
- reduction in paving weight to be borne by supporting structure
- excellent capability for absorbing expansion/contraction and structural settlement
- the creation of a technical cavity between the top surface and the underlying structure, to accommodate wiring, pipes and any other systems in a concealed position which is still easily accessible for inspection and any repairs
- the use of completely reusable, recyclable materials, in full compliance with principles of circularity and environmental sustainability.

PLANCHERS SURÉLEVÉS EXTÉRIEUR

Avec les surfaces Emilgroup de 20 mm d'épaisseur, il est possible de réaliser des planchers surélevés dans tous les contextes extérieurs en intervenant de manière simple, rapide et sûre, sur les structures existantes, sans travaux particulièrement onéreux. Basées sur des systèmes modulaires et réglables, ces applications forment des revêtements de sol uniformes et stylistiquement sophistiqués qui comportent d'innombrables avantages techniques et logistiques, dont entre autres :

- suppression des problèmes d'humidité, d'infiltration et d'écoulement des eaux ;
- optimisation du calorifugeage et de l'insonorisation ;
- très grande résistance aux charges et contraintes ;
- diminution du poids du revêtement de sol sur le support ;
- excellente capacité d'absorption des dilatations et des mouvements structurels ;
- création d'un vide technique entre les surfaces de piétement et la structure sous-jacente pour y dissimuler les câbles, tuyaux et autres équipements qui restent, néanmoins, facilement contrôlables et, le cas échéant, réparables ;
- utilisation de matériels totalement réutilisables et recyclables selon les principes de l'économie circulaire et du développement durable.

DOPPELBÖDEN FÜR AUSSENBEREICH

Bei Verwendung der 20 mm starken Oberflächen von Emilgroup können in jeder Umgebung Doppelböden für Projekte im Außenbereich hergestellt werden. Die Arbeiten dazu sind einfach, schnell und sicher und erfolgen auf den bereits bestehenden Strukturen, ohne dass besonders aufwendige Bauarbeiten erforderlich sind. Da es sich um modulare und verstellbare Systeme handelt, können damit einheitliche und stilistisch edle Fußböden hergestellt werden, die zahlreiche technische und logistische Vorteile zu bieten haben. Die wichtigsten Vorteile:

- keine Probleme mit Feuchtigkeit, eindringendem Wasser oder Staunässe
- verbesserte Wärme- und Schalldämmung
- hohe Widerstandsfähigkeit gegen Lasten und Belastungen eduziertes Gewicht des Fußbodens auf der Auflagefläche
- hervorragende Absorbierung von Ausdehnung und strukturellen Bewegungen
- Schaffung eines technischen Raums zwischen der Trittläche und der darunterliegenden Struktur, in dem Kabel, Schläuche und andere Anlagen untergebracht werden können, die nicht zu sehen, aber leicht zu kontrollieren und ggf. zu reparieren sein sollen
- Einsatz von vollständig wieder verwendbarem und recycelbarem Material in Einhaltung des Kreislauf- und Nachhaltigkeitsprinzips.

PAVIMENTOS SOBREELEVADOS PARA EXTERIORES

Gracias al grosor de 20 mm de las superficies de Emilgroup se pueden llevar a cabo pavimentaciones sobreelevadas en cualquier contexto proyectivo al aire libre, actuando de manera sencilla, rápida y segura sobre las estructuras ya existentes, sin tener que efectuar obras particularmente costosas. Al estar basadas en sistemas modulares y regulables, tales aplicaciones permiten disponer pavimentos uniformes y estéticamente sofisticados que conllevan numerosas ventajas técnicas y logísticas, entre las que cabe destacar:

- la eliminación de todo problema de humedad, filtraciones de agua y dificultades de desagüe;
- un mejor aislamiento térmico y acústico;
- una elevada resistencia a las cargas y sollicitaciones;
- una reducción del peso de la pavimentación sobre la estructura en la que se coloca;
- una excelente capacidad de absorción de las dilataciones y los movimientos estructurales;
- la creación de un hueco técnico entre las superficies transitables y la estructura subyacente para el alojamiento de cables, tubos y demás instalaciones ocultas a la vista, pero al mismo tiempo fácilmente inspeccionables y reparables, si resulta necesario;
- el empleo de materiales completamente reutilizables y reciclables, respetando al máximo los principios de circularidad y sostenibilidad medioambiental.

ФАЛЬШПОЛЫ ДЛЯ ЭКСТЕРЬЕРОВ

Благодаря материалам Emilgroup толщиной 20 мм можно изготавливать фальшполы в любых условиях проектирования наружных пространств, выполняя работы просто, быстро и безопасно на уже существующих конструкциях, без необходимости выполнения достаточно затратных строительных работ. Основываясь на модульных и регулируемых системах, эти применения позволяют настлать однородные полы в изысканном стиле, обладающие многочисленными техническими и логистическими преимуществами. Основными из них являются:

- устранение проблем, связанных с влажностью, просачиванием воды и сложностями ее отвода
- лучшая тепловая и звуковая изоляция
- высокая стойкость к нагрузкам и воздействию
- снижение веса пола, лежащего на опорной конструкции
- отличная способность поглощать расширения и структурные подвижки
- создание технологического пространства между поверхностью для хождения и находящейся под ней конструкцией для прокладки кабелей, труб и других типов скрытых систем, но при возможности их быстрого осмотра и ремонта в случае необходимости.
- применение материалов, подлежащих полному повторному использованию, максимально соблюдая принципы обращения и экологической рациональности.

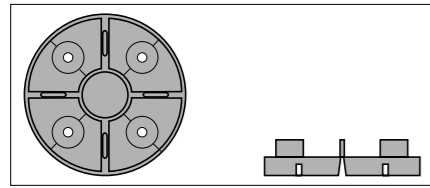

SUPPORTI FISSI

Fixed pedestals
Plots fixes
Feststehende Bodenstützen
Fijos
Фиксированные опоры

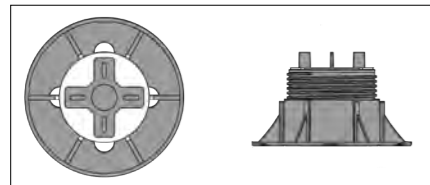

SUPPORTI REGOLABILI IN ALTEZZA

Adjustable-height pedestals
Plots réglables en hauteur
Höhenverstellbare Bodenstützen
De altura graduable
Опоры с регулировкой по высоте

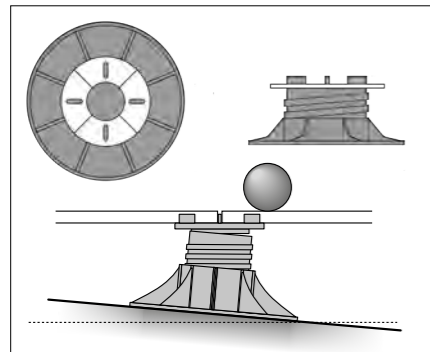

SUPPORTI REGOLABILI IN ALTEZZA AUTOLIVELLANTI

Self-levelling adjustable-height pedestals
Plots autonivelants réglables en hauteur
Höhenverstellbare Selbstnivellierende Bodenstützen
De altura graduable autonivelantes
Самовыравнивающиеся опоры с регулировкой по высоте

I SUPPORTI

I supporti hanno una funzione di sostegno e possiedono un'elevata resistenza meccanica.

Sono realizzati prevalentemente in materiale riciclabile e riciclato, resistono a soluzioni acide e basiche, agli agenti atmosferici ed a temperature da -30° a +120°.

I supporti per esterno sono concepiti per essere regolabili in altezza e prevedono accessori che consentono la correzione di pendenza fino ad un massimo del 5%.

I supporti si distinguono nelle seguenti tipologie:

- SUPPORTI FISSI
- SUPPORTI REGOLABILI IN ALTEZZA
- SUPPORTI REGOLABILI IN ALTEZZA AUTOLIVELLANTI

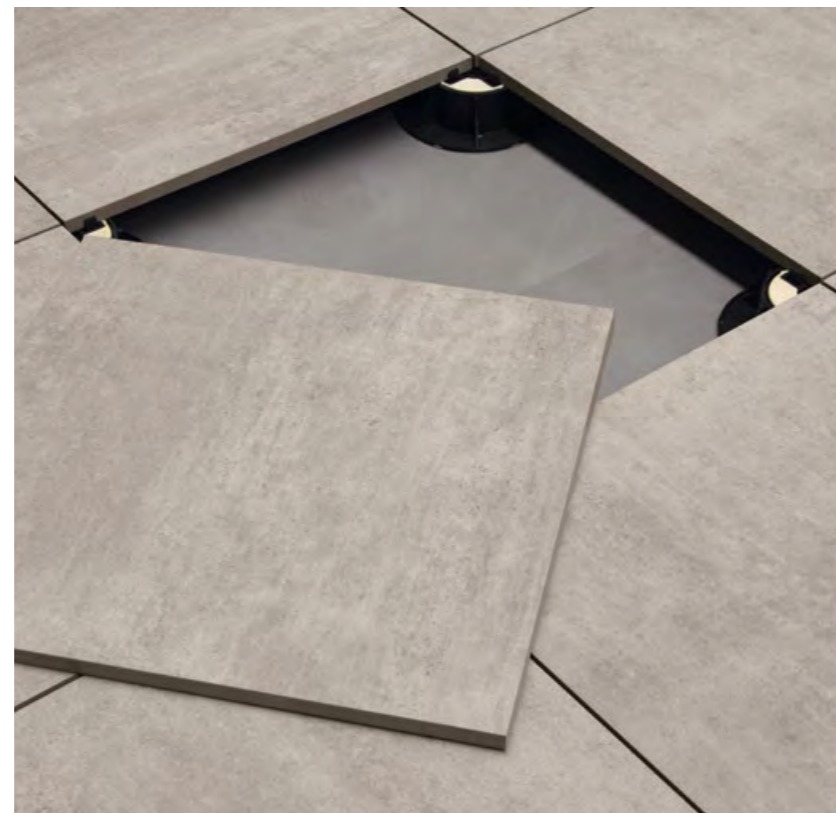

THE PEDESTALS

The pedestals support the paving and have excellent mechanical strength. They are mainly made from recyclable and recycled material and withstand acid and base solutions, weather and temperatures from -30° to +120°. Outdoor pedestals are designed to be height-adjustable and have accessories which allow correction of the gradient up to a maximum of 5%. The pedestals are divided into the following types:

- Fixed pedestals
- Adjustable-height pedestals
- Self-levelling adjustable-height pedestals

LES PLOTS

Les plots servent à soutenir et possèdent une très grande résistance mécanique. Ils sont fabriqués principalement en matière recyclable et recyclée, résistent aux acides et bases, aux agents atmosphériques et à des températures de -30 ° à +120 °C. Les plots pour extérieur sont réglables en hauteur et ils s'accompagnent d'accessoires permettant la correction d'inclinaison jusqu'à un maximum de 5 %. Il existe les types de plots ci-après :

- Plots fixes
- Plots réglables en hauteur
- Plots autonivelants réglables en hauteur

BODENSTÜTZEN

Die Bodenstützen dienen als Träger und besitzen hohe mechanische Festigkeit. Sie sind hauptsächlich aus recyclingfähigen Werkstoffen und Recyclingmaterialien hergestellt, säure- und laugenbeständig, witterungsbeständig und resistent gegenüber Temperaturen von -30° bis +120°. Die Bodenstützen für Außenbereiche sind höhenverstellbar und sehen Zubehör vor, mit dem die Neigung bis zu maximal 5 % verstellt werden kann. Folgende Arten von Bodenstützen sind erhältlich:

- Feststehende Bodenstützen
- Höhenverstellbare Bodenstützen
- Höhenverstellbare Selbstnivellierende Bodenstützen

SOPORTES

Los soportes tienen una función de sostén y poseen una elevada resistencia mecánica. Están constituidos sobre todo por material reciclable y reciclado, son resistentes a ácidos y bases, a los agentes atmosféricos y a temperaturas de -30 a +120 °C. Los soportes para exterior están concebidos para que se pueda graduar su altura y prevén accesorios que permiten corregir pendientes hasta un máximo del 5%. Existen soportes de los tipos siguientes:

- Fijos
- De altura graduable
- De altura graduable autonivelantes

ОПОРЫ

Опоры выполняют несущую функцию и обладают высокой механической прочностью. Они состоят главным образом из переработанного материала, подлежащего дальнейшей переработке. Они выдерживают воздействие кислотных и щелочных растворов, атмосферное воздействие и температуру от -30° до +120°. Опоры для наружных работ имеют возможность регулировки по высоте и предусматривают аксессуары, позволяющие корректировать высоту вплоть до 5% максимум. Опоры могут быть следующих типов:

- Фиксированные опоры
- Опоры с регулировкой по высоте
- Самовыравнивающиеся опоры с регулировкой по высоте

PEDESTAL LAYOUTS

All Emilgroup products 20 mm thick are suitable for installation on outdoor raised paving systems. A number of pedestals appropriate to the size of the tiles must be used for installation (see table). NB: the number of pedestals per square metre refers to a surface of average size and regular geometrical form, and is purely guideline. For correct calculation of the precise number, the design should be provided to your supplier, who will draw up the bill of materials to be purchased.

CONCEPTION DES PLOTS

Tous les produits Emilgroup de 20 mm d'épaisseur peuvent être posés en extérieur sur des planchers surélevés. Le nombre de plots doit être calculé en fonction des dimensions du carreau (voir tableau). N.B. : le nombre de plots par mètre carré se rapporte à une surface de moyenne dimension avec développement linéaire. Ce nombre est donné à titre purement indicatif. Pour un bon calcul d'exécution, il est recommandé de transmettre le projet au fournisseur qui rédigera la nomenclature d'achat.

AUSFÜHRUNG DER BODENSTÜTZEN

Alle Emilgroup-Produkte in der Stärke 20 mm eignen sich für die Doppelbodenmontage in Außenbereichen. Die Installation muss mit einer für die gewählte Fliesengröße ausreichenden Anzahl von Bodenstützen ausgeführt werden (siehe Tabelle). NB: the number of pedestals per square metre refers to a surface of average size and regular geometrical form, and is purely guideline. For correct calculation of the precise number, the design should be provided to your supplier, who will draw up the bill of materials to be purchased.

DESARROLLO DE LOS SOPORTES

Todos los productos de Emilgroup con un grosor de 20 mm son adecuados para su instalación sobre pavimentos sobre elevados para exterior. La instalación debe llevarse a cabo empleando el número oportuno de pies según las medidas de la placa (ver tabla). NB: el número de soportes por metro cuadrado es meramente orientativo y debe considerarse con respecto a una superficie de tamaño medio y trazado regular. Para formular un correcto cálculo de ejecución, se aconseja mostrarle el proyecto al proveedor, que de este modo podrá presentar la lista de materiales que comprar.

РАСЧЕТ ОПОР

Вся продукция Emilgroup толщиной 20 мм пригодна для настла наружных фальшполов. Установка должна выполняться с использованием подходящего количества опор, в зависимости от размера плитки (см. таблицу ниже). Примечание: количество опор на квадратный метр приводится применительно к поверхности средних размеров с прямолинейными формами и должно считаться лишь только ориентировочным. Для правильного расчета необходимого количества рекомендуем показать проект поставщику, который составит закупочную калькуляцию.

SVILUPPO DEI SUPPORTI

Tutti i prodotti Emilgroup con uno spessore di 20 mm sono adatti per essere installati su pavimenti sopraelevati per esterno. L'installazione deve essere eseguita con il numero adeguato di piedistalli in base alle dimensioni della piastrella (vedi tabella seguente).

NB: il numero di supporti al metro quadrato si intende relativo ad una superficie di medie dimensioni con sviluppo lineare ed è da ritenersi puramente indicativo. Per un corretto calcolo esecutivo, si consiglia di sottoporre il progetto al fornitore che provvederà a realizzare la distinta base d'acquisto.

Formato Size Format Format Tamaño Формат	N° supporti per piastrella No. pedestals per tile Nbre de plots par dalle Anz. Bodenstützen pro Platte N° de soportes por placa Кол. опор на плитку	N° supporti per mq No. pedestals per SqM Nbre de plots par m² Anz. Bodenstützen pro qm N° de soportes por metro cuadrado Кол. опор на кв.м.
60x60 cm - 24"x24" (nominal)	4	2,78
45x90 cm - 18"x36" (nominal)	6	4,94
40x120 cm - 16"x48" (nominal)	6	4,17
60x90 cm - 24"x36" (nominal)	6	3,70
60x120 cm - 24"x48" (nominal)	6	2,78
80x80 cm - 24"x48" (nominal)	5	6,25
50x100 cm - 24"x48" (nominal)	6	4

SEZIONE TECNICA

TECHNICAL INFORMATION

SECTION TECHNIQUE

TECHNISCHE ANGABEN

SECCION TÉCNICA

ТЕХНИЧЕСКИЙ РАЗДЕЛ

Proposte di posa Installation suggestions Croquis de pose Verlegungsvorschläge Sugerencias de composicion Предложения по укладке	250
Pezzi speciali Trims Pieces especiales Formteile Piezas especiales Специальные изделия	254
Posa Laying Pose Verlegung Composicion Укладка	256
Caratteristiche tecniche generali secondo le norme General technical specifications in compliance with standards Caracteristiques techniques generales selon les normes Allgemeine technische eigenschaften nach den normen Características técnicas generales conformes con las normas Общие технические характеристики по нормам	257
Certificazioni Certifications Certifications Zertifizierungen Certificaciones Сертификаты	260
SLABS 6,5mm Movimentazione imballi e lastre Packaging and slabs handling Manutention emballages et dalles Verpackung und Platten Handhabung Desplazamiento embalajes Y placas Обработка упаковки и плит	266
Consigli di Manutenzione Advice for Maintenance Conseil d'entretien Pflegehinweise Consejos de mantenimiento Инструкции по эксплуатации	272
Destinazioni d'uso Intended uses Domaines d'application Zweckbestimmung Usos previstos Назначение	280
Il taglio delle piastrelle in gres porcellanato Cutting porcelain stoneware tiles La découpe des carreaux en gres cerame Schneiden von Feinsteinzeugfliesen Corte de los azulejos de gres porcelánico Резка керамогранитной плитки	281
Condizioni generali di vendita e garanzie General conditions of sale for export and guarantees Conditions generales de vente a l'exportation et de garantie Allgemeine verkaufs - und garantiebedingungen Condiciones generales de venta y garantias Общие условия продажи и гарантии	284

PROPOSTE DI POSA

Installation suggestions | Croquis de pose | Verlegungsvorschläge | Sugerencias de composicion | Предложения по укладке

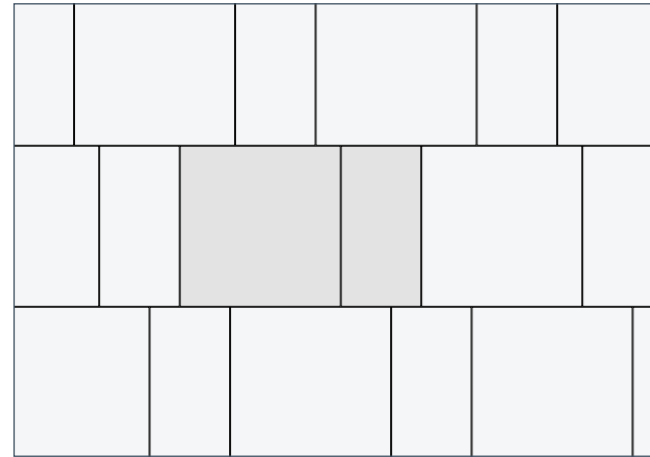

1A 60x60 66,7%
30x60 33,3%

1B 80x80 66,7%
40x80 33,3%

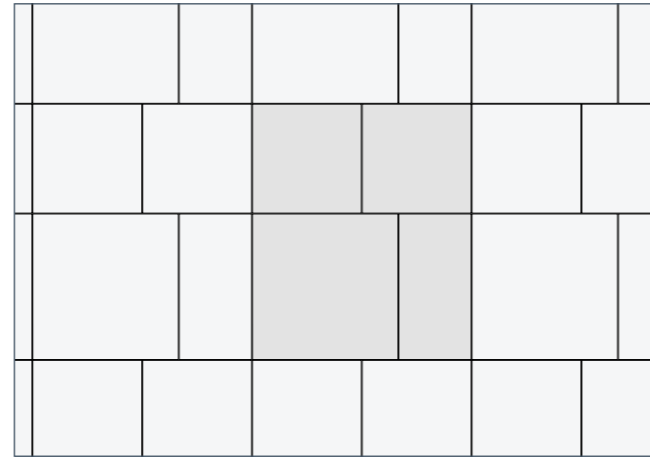

2 80x80 38,1%
40x80 19,0%
60x60 42,9%

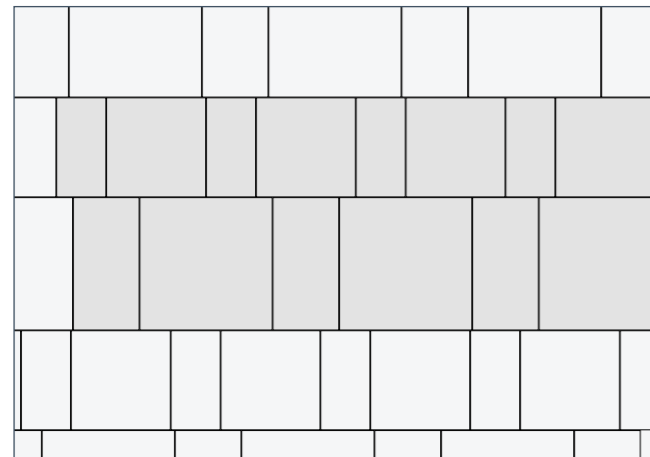

3 80x80 38,1%
40x80 19,0%
60x60 28,6%
30x60 14,3%

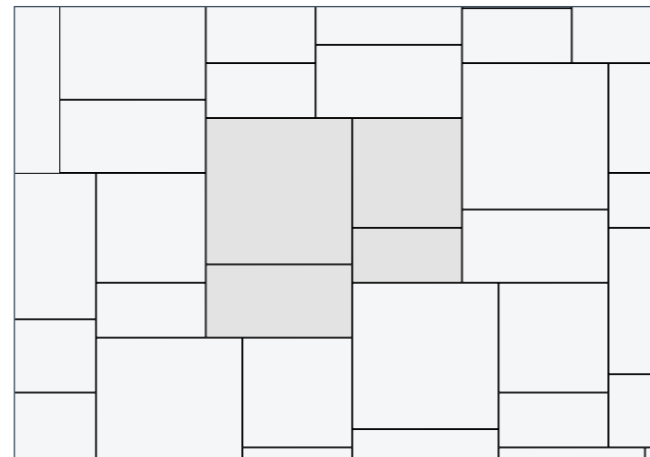

4 80x80 42,7%
40x80 21,3%
60x60 24,0%
30x60 12,0%

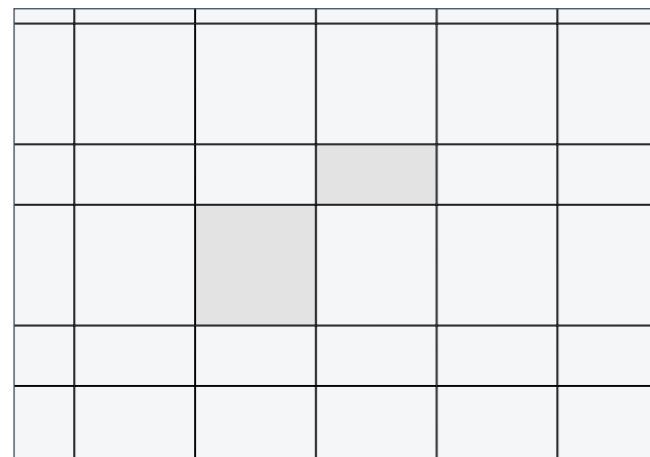

5A 60x60 66,7%
30x60 33,3%

5B 80x80 66,7%
40x80 33,3%

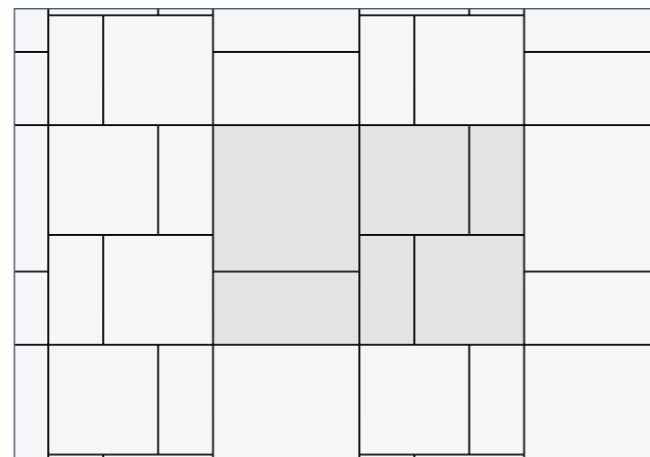

6 80x80 31,4%
40x80 15,7%
60x60 35,3%
30x60 17,6%

PROPOSTE DI POSA

Installation suggestions | Croquis de pose | Verlegungsvorschläge | Sugerencias de composicion | Предложения по укладке

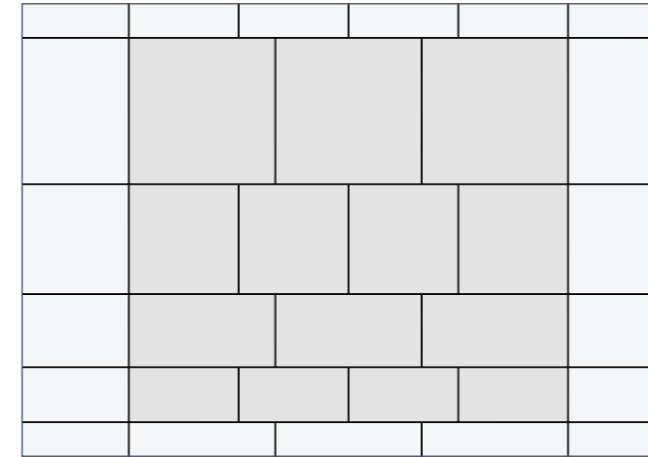

7 80x80 38,1%
40x80 19,0%
60x60 28,6%
30x60 14,3%

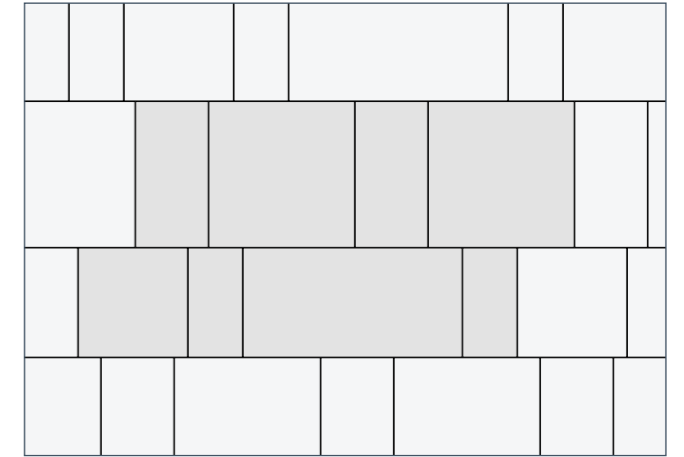

8 60x120 21,5%
60x60 10,7%
30x60 10,7%
80x80 38,1%
40x80 19,0%

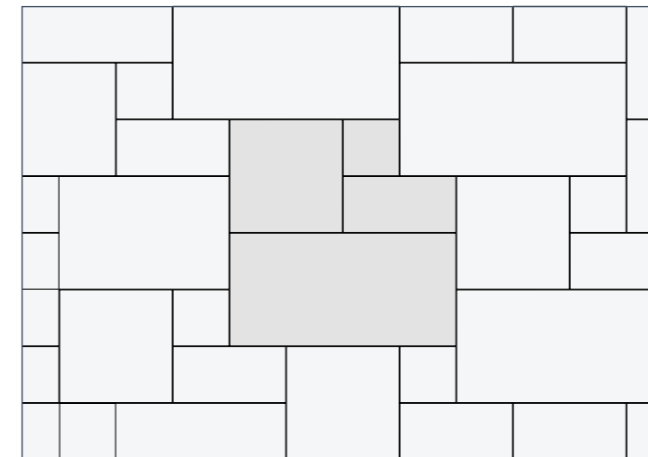

9 60x120 53,3%
60x60 26,7%
30x60 13,3%
30x30 6,7%

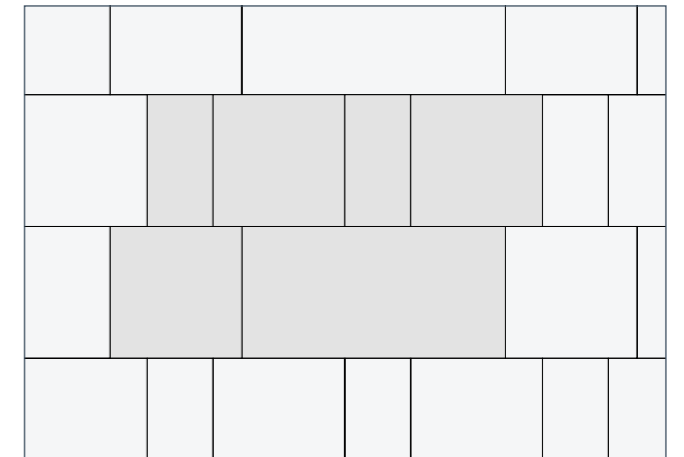

10 60x120 33,3%
60x60 50%
30x60 16,7%

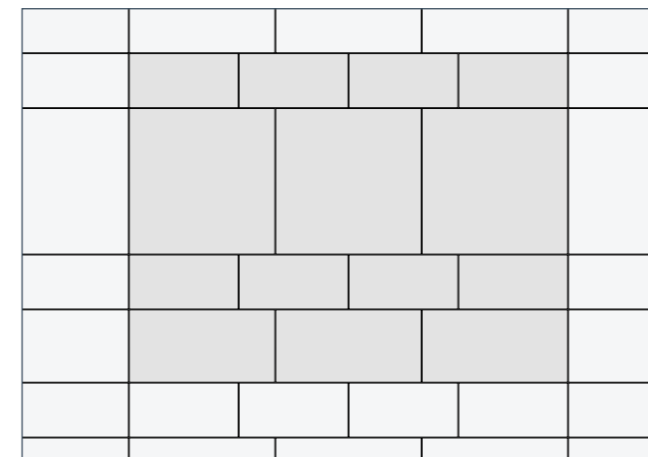

11 80x80 44,4%
40x80 22,2%
30x60 33,4%

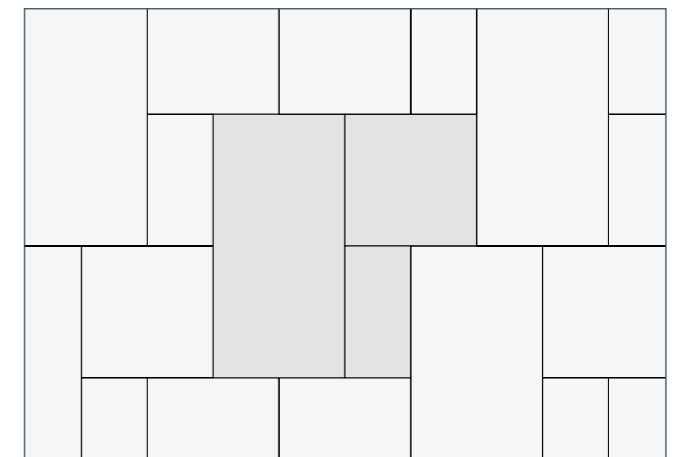

12 60x120 57,1%
60x60 28,6%
30x60 14,3%

PROPOSTE DI POSA

Installation suggestions | Croquis de pose | Verlegungsvorschläge | Sugerencias de composicion | Предложения по укладке

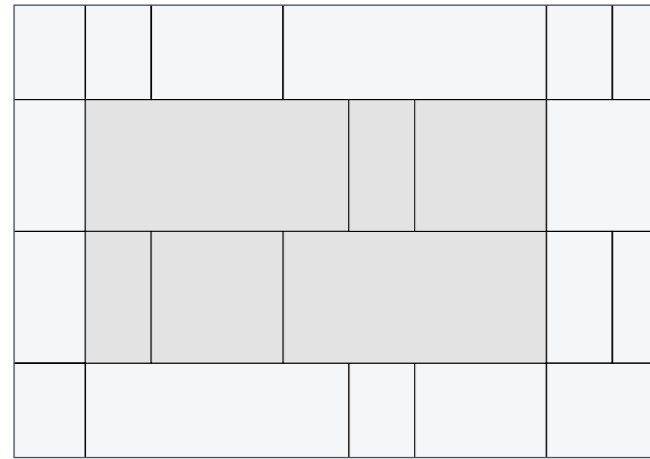

13 60x120 57,1%
60x60 28,6%
30x60 14,3%

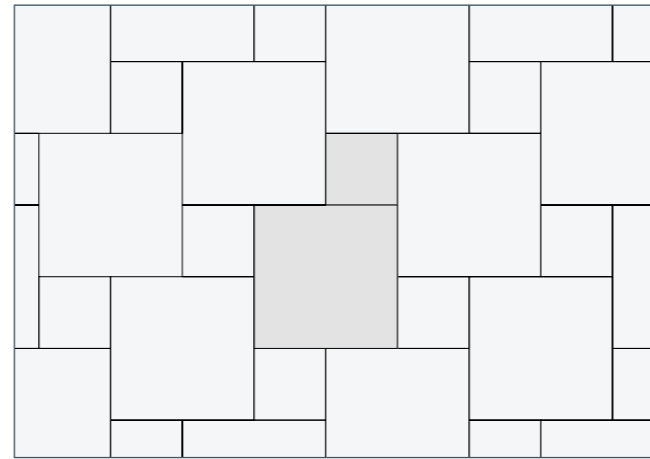

14 60x60 80,5%
30x30 19,5%

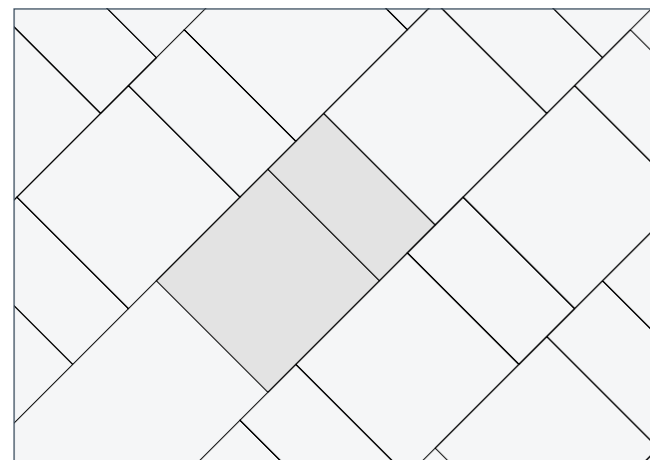

15 60x60 67%
30x60 33%

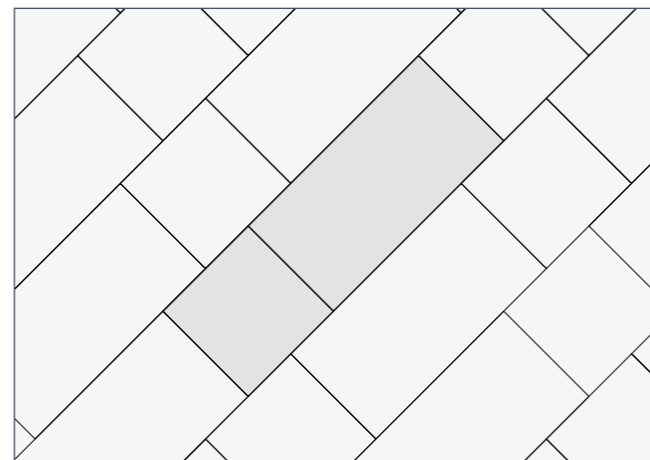

16A 60x120 66,7%
60x60 33,3%

16B 30x60 66,7%
30x30 33,3%

16C 20x40 66,7%
20x20 33,3%

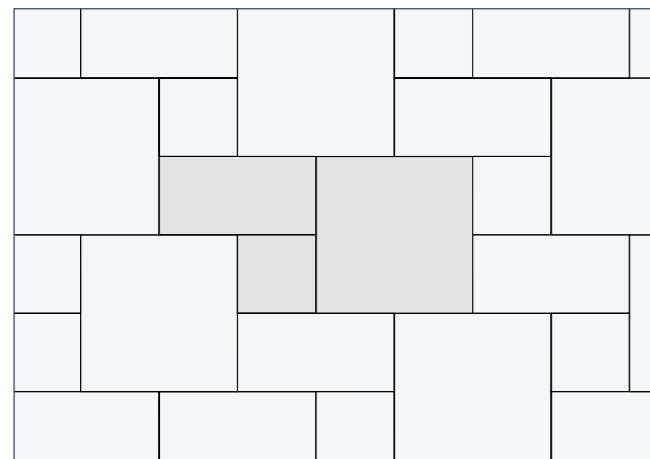

17 60x60 57,1%
30x60 28,6%
30x30 14,3%

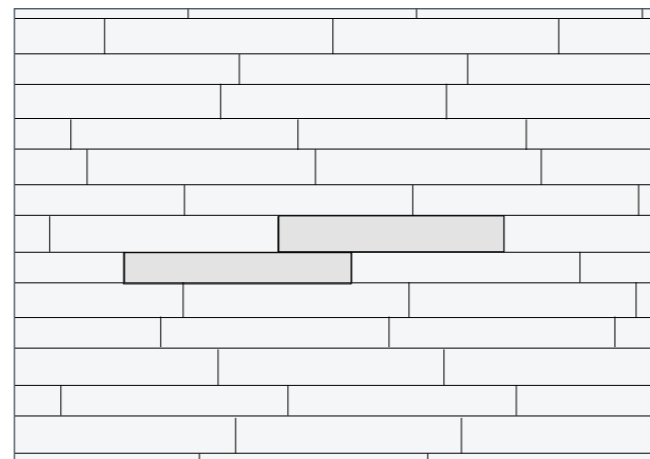

18 20x120 57,1%
15x120 42,9%

PROPOSTE DI POSA

Installation suggestions | Croquis de pose | Verlegungsvorschläge | Sugerencias de composicion | Предложения по укладке

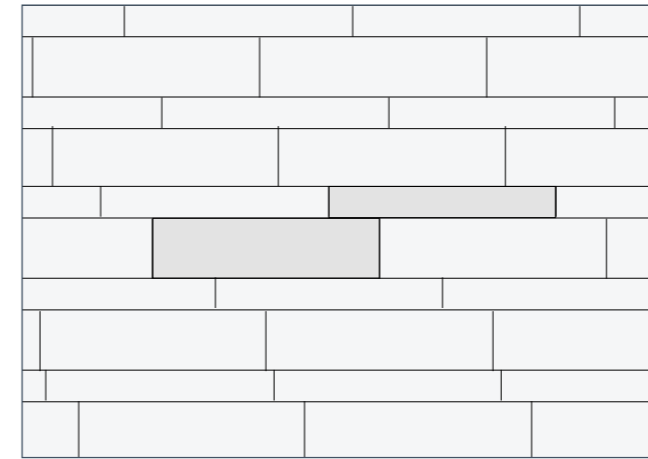

19 30x120 66,7%
15x120 33,3%

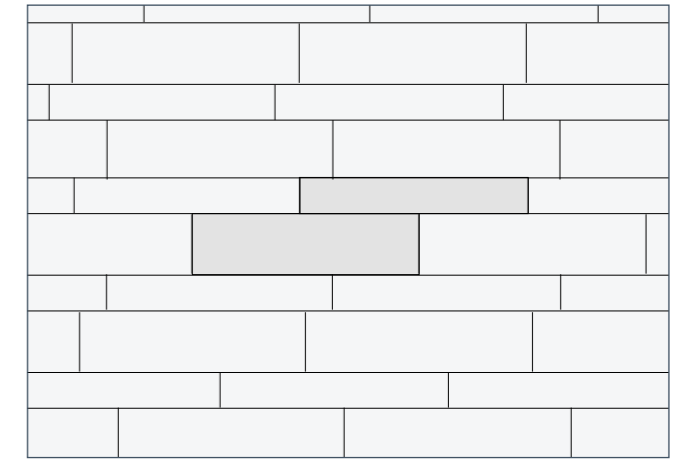

20 30x120 60,0%
20x120 40,0%

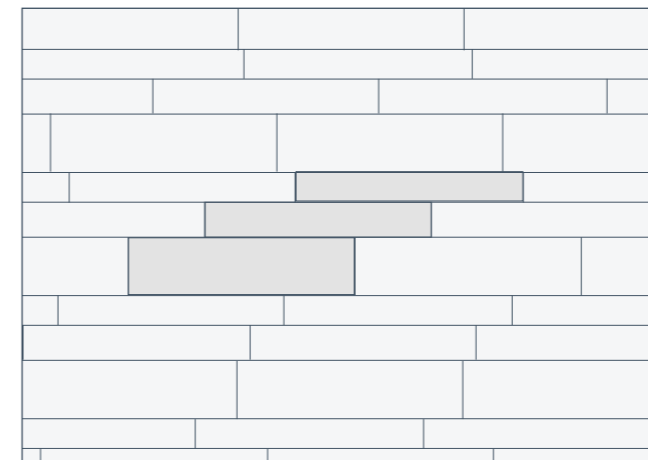

21 30x120 46,1%
20x120 30,8%
15x120 23,1%

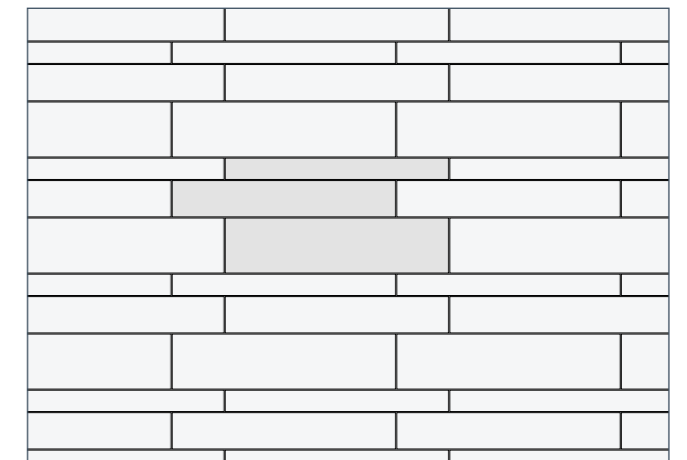

22 30x120 46,1%
20x120 30,8%
15x120 23,1%

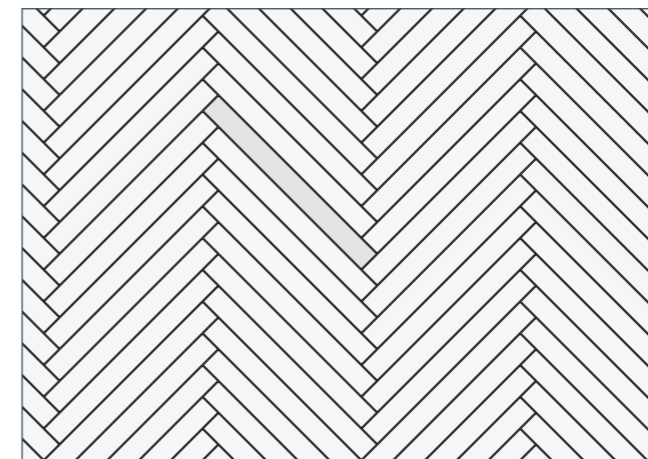

23 15x120 100,0%

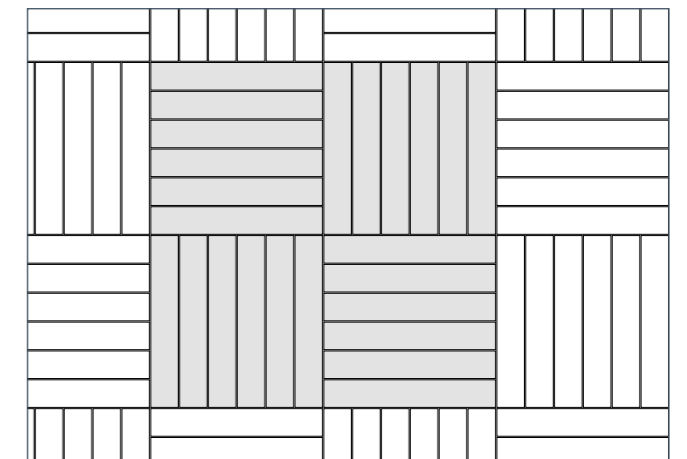

24A 15x90 100,0%

24B 20x120 100,0%

PEZZI SPECIALI

Trims | Pieces spéciales | Formteile | Piezas especiales | Специальные изделия

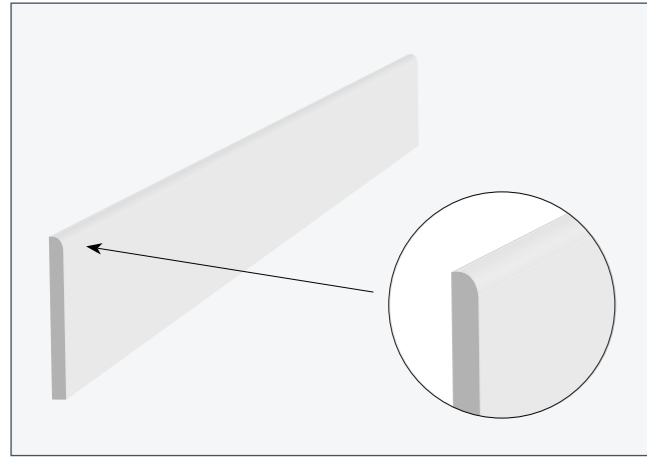

Battiscopa - Skirting

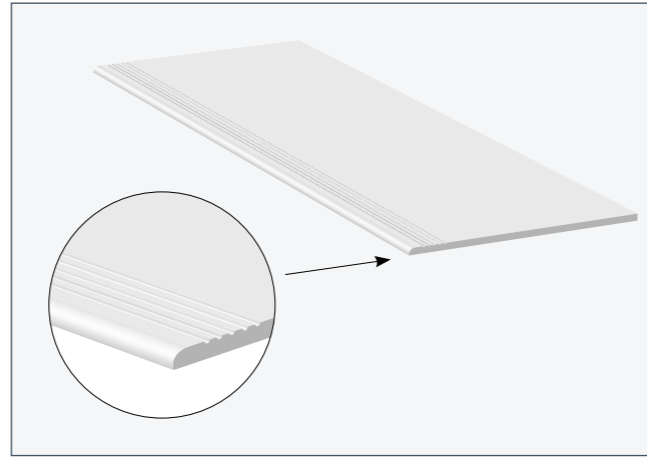

Gradino - Stair Tread

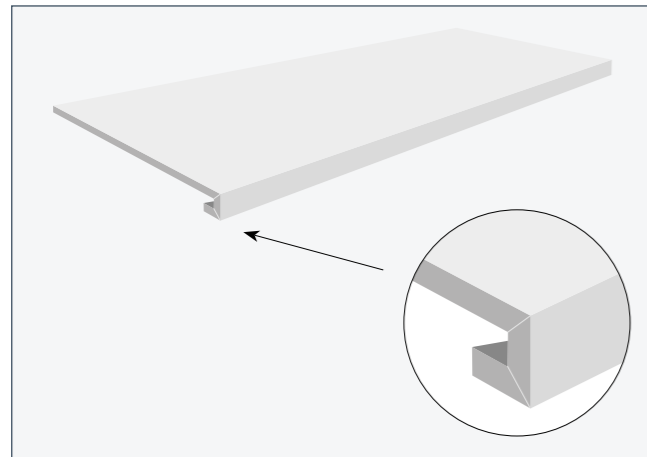

Gradone - Step

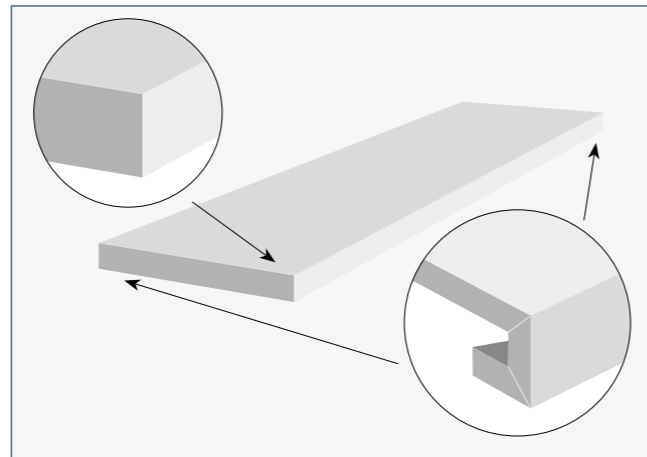

Angolare Dx | Sx - Corner Tile Dx | Sx

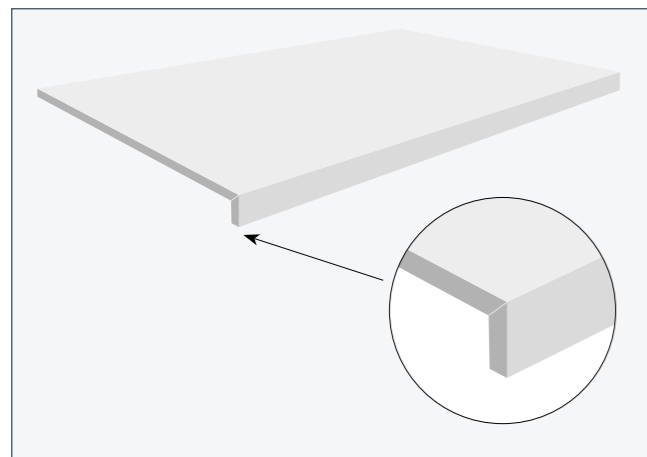

Elemento a "L" - L Shaped Piece

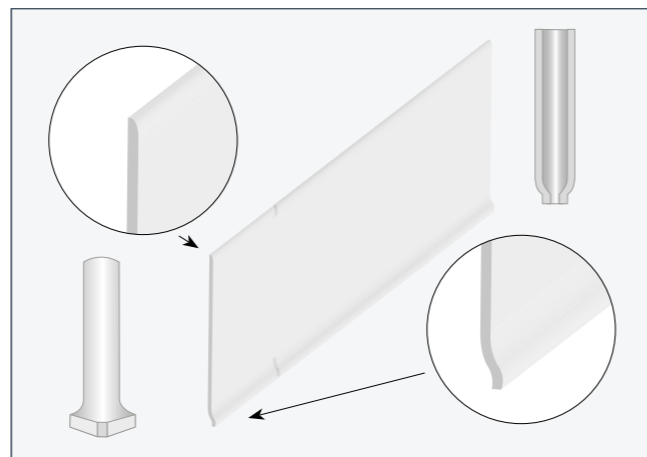

Cove Base con Angolo Esterno e Interno
Cove Base with Outer and Inner Corner

20MM PEZZI SPECIALI

Trims | Pieces spéciales | Formteile | Piezas especiales | Специальные изделия

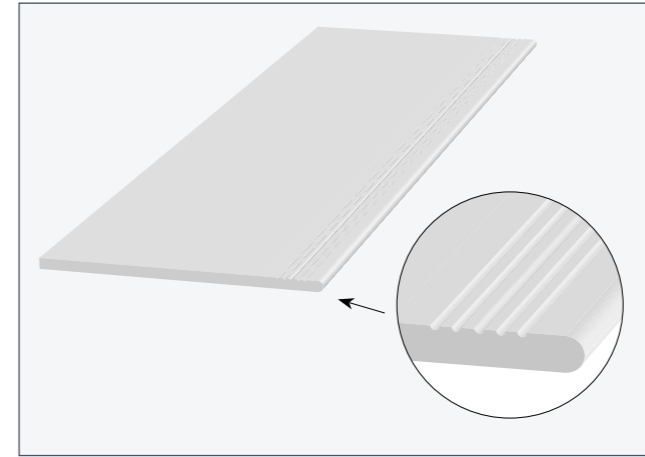

Gradino - Stair Tread

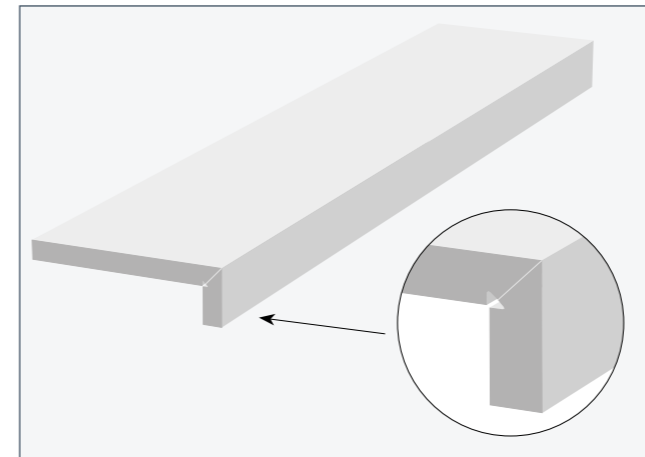

Gradone - Step

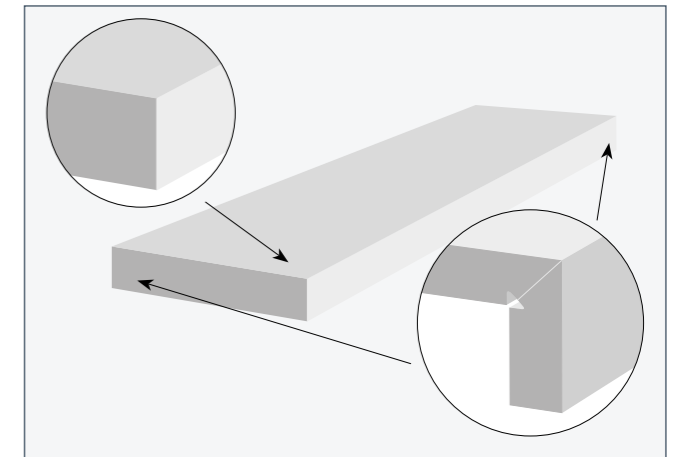

Angolare Dx | Sx - Corner Tile Dx | Sx

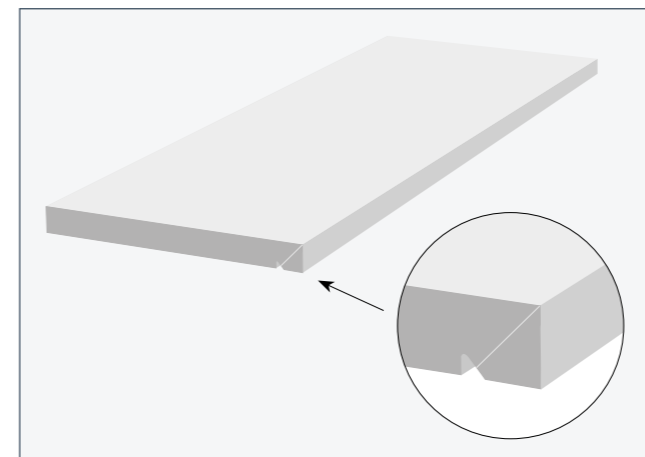

Terminale - Endingpiece

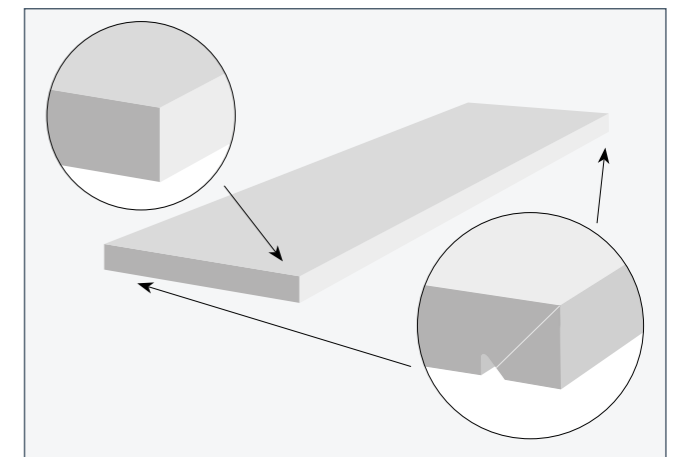

Angolo Terminale Dx | Sx - Endingpiece Corner Dx | Sx

EMILCERAMICA

POSA

Laying | Pose | Verlegung | Composicion | Укладка

GRADONE

I prodotti assemblati sono realizzati con collante tixotropico bi-componente ad alta reattività allo scopo di fornire al posatore un oggetto agevolmente installabile. Si ricorda ai signori posatori che la tenuta in opera nel tempo deve essere assicurata da un corretto riempimento del retro dello scalino o del bordo a elle.

La funzione di sgocciolatoio degli elementi a elle può essere realizzata con un riempimento parziale del retro che si limiti ai circa i 3/4 della lunghezza del frontalino.

STEP TILE

Pieces produced by combining more than one element are fixed together with a highly reactive dual compound thixotropic adhesive to provide the installer with an object which is easily laid. Installers are reminded that to ensure that tiles remain firmly in place over time, the back of the step or L-shaped edging tile must be filled in correctly. To allow L-shaped edging tiles to provide drainage, only part of the back can be filled in, up to about 3/4 of the length of the front.

MARCHE

Les produits sont assemblés avec une colle bi-composant thixotrope très réactive pour simplifier la pose. Nous rappelons aux carreleurs de bien remplir la face arrière de la marche ou le bord en L pour garantir l'adhérence à long terme. Pour réaliser le larmier des éléments en L, remplir en partie la face arrière, maximum 3/4 environ de la longueur du nez de marche.

STUFENABSCHLUSSFLIESE

Die mehrteiligen Produkte sind mit einem thixotropen Zweikomponenten-Kleber mit hoher Reaktionsfähigkeit für eine einfache Verlegung ausgeführt. Für eine hohe Langzeitqualität des Gewerkes ist eine ordnungsgemäße Ausfüllung der Rückseite des Treppenauftritts oder der L-Kante erforderlich. Die Abflussfunktion der L-Elemente kann mit einer teilweisen Ausfüllung der Rückseite auf ungefähr 3/4 der Frontteillänge erzielt werden.

ESCALÓN

Los productos ensamblados se fabrican con adhesivo tixotrópico bicomponente de alta reactividad con el fin de proporcionarle al solador un objeto de fácil instalación. Se recuerda a los soladores que la durabilidad de la obra se asegura rellenando correctamente la parte de atrás del escalón o del borde en forma de "L". La función de vierteaguas de los elementos en forma de "L" se puede conseguir rellenando el reverso sólo hasta aproximadamente tres cuartos de la longitud de la contrahuella para de este modo formar un goterón.

СТУПЕНЬ

Сборные изделия склеиваются с применением очень реактивного тиксотропного двухкомпонентного состава, что позволяет предоставлять плиточнику легко монтируемое изделие. Напоминаем плиточникам, что для обеспечения долговечности монтажа необходимо правильно заполнять тыльную сторону ступени или Г-образного края. Чтобы обеспечить стекание воды с Г-образных элементов, можно предусмотреть частичное заполнение длины загиба с тыльной стороны, приблизительно на 3/4.

ISO 13006/UNI EN 14411 E UNI EN ISO 10545/1-16

CARATTERISTICHE TECNICHE GENERALI SECONDO LE NORME

General technical specifications in compliance with standards | Caracteristiques techniques generales selon les normes

Allgemeine technische eigenschaften nach den normen | Caracteristicas tecnicas generales conformes con las normas | Общие технические характеристики по нормам

Le norme ISO (International Organization for Standardization), sono adottate e pubblicate in tutti i paesi aderenti (oltre 150 Paesi nel mondo). La ISO 13006 classifica le piastrelle di ceramica in base al metodo di formatura e all'assorbimento d'acqua e per ciascun gruppo definisce le caratteristiche e i requisiti per le piastrelle di 1a SCELTA. La norma EN 14411 è stata pubblicata dal CEN (Comitato Europeo di Normazione e riporta nell'appendice ZA la parte "armonizzata", che costituisce lo strumento per l'apposizione della marcatura CE, ai sensi del vigente Regolamento del Parlamento europeo per la commercializzazione dei prodotti da costruzione. La marcatura CE è obbligatoria per la circolazione delle piastrelle all'interno dell'UE, essa riguarda le piastrelle di tutte le scelte commerciali e prende in considerazione i requisiti essenziali di sicurezza in base alla destinazione d'uso dichiarata dal produttore.

Tutti i prodotti Emilceramica sono marcati CE e classificati per destinazione d'uso, in seguito al superamento delle prove iniziali e periodiche previste della norma UNI EN 14411 nella revisione corrente.

Le norme UNI EN ISO 10545/1-16 forniscono i metodi di prova e di campionamento, per la verifica delle caratteristiche stabilite dalla ISO 13006 e UNI EN 14411.

The ISO (International Organisation for Standardization) standards have been adopted and published in all the associated countries (over 150 countries in the world). The ISO 13006 classifies ceramic tiles according to the moulding methods and water absorption and for each group it defines the characteristics and requisites for FIRST GRADE tiles.

The EN 14411 standard was published by the CEN (European Committee for Standardization) and includes the "harmonised" part in appendix ZA, which constitutes the tool for affixing the EC mark according to the effective European Parliament regulation for the sale of construction products.

The EC mark is obligatory for the circulation of tiles within the EU. This regards tiles of all grades on the market and taking into consideration the essential requirements for "safety" according to the intended use declared by the manufacturer.

All Emilceramica products are marked EC and are classified for destination of use after passing the initial and periodic tests set down in the current version of the UNI EN 14411 standard.

The UNI EN ISO 10545/1-16 standards set out the testing and sampling methods to check the characteristics prescribed by ISO 13006 and UNI EN 14411.

Les normes ISO (International Organization for Standardization) sont adoptées et publiées dans tous les pays qui y ont adhéré (plus de 150 pays dans le monde). La norme ISO 13006 classe les carreaux et dalles céramiques selon la méthode de fabrication et l'absorption d'eau, et pour chaque groupe, elle précise les caractéristiques et les qualités requises pour les carreaux de 1er CHOIX.

La norme EN 14411 a été publiée par le CEN (Comité Européen de Normalisation) et elle reprend dans l'annexe ZA la partie « harmonisée » qui est l'instrument pour l'aposition du marquage CE, aux termes du Règlement du Parlement européen pour la commercialisation des produits de construction. Le marquage CE est obligatoire pour la circulation des carreaux au sein de l'U.E. Il concerne les carreaux de tous choix commerciaux et il tient compte des exigences essentielles de sécurité en fonction de l'usage déclaré par le fabricant.

Tous les produits Emilceramica sont marqués CE et classés selon l'usage après avoir réussi les essais initiaux et les audits périodiques prévus par la version actuelle de la norme UNI EN 14411.

Les normes UNI EN ISO 10545/1-16 fournissent les méthodes d'essai et d'échantillonnage pour le contrôle des caractéristiques établies par les normes ISO 13006 et UNI EN 14411.

Die ISO-Normen (ISO - International Organization for Standardization) werden in allen Mitgliedsländern (mehr als 150 Länder) angewendet und veröffentlicht. Die Norm ISO 13006 klassifiziert die Keramikfliesen auf der Grundlage des Formgebungsverfahrens und der Wasseraufnahme und legt für jede Gruppe die Eigenschaften und Anforderungen für Fliesen der 1. WAHL fest.

Die Norm EN 14411 wurde vom CEN (Europäische Komitee für Normung) veröffentlicht und enthält im Anhang ZA den harmonisierten Teil, der die Vorschriften für die Anbringung des CE-Zeichens gemäß der Verordnung des Europäischen Parlaments für die Vermarktung von Bauprodukten festlegt. Die CE-Kennzeichnung ist innerhalb der EU für die Inverkehrbringung der Fliesen zwingend erforderlich. Sie betrifft Fliesen aller Handelssortierungen und berücksichtigt die grundlegenden Sicherheitsanforderungen gemäß dem vom Hersteller deklarierten Anwendungsbereich.

Sämtliche Produkte von Emilceramica haben die anfänglichen und regelmäßigen Prüfungen gemäß der Norm UNI EN 14411 in der aktuell gültigen Fassung bestanden. Auf dieser Grundlage sind sie mit dem CE-Zeichen versehen und nach Anwendungsbereich klassifiziert.

Die Normen UNI EN ISO 10545/1-16 legen die Prüf- und Probeentnahmeverfahren für die Überprüfung der nach ISO 13006 und UNI EN 14411 vorgeschriebenen Eigenschaften fest.

Las normas ISO (International Organization for Standardization) se adoptan y están publicadas en todos los países adheridos (más de 150 estados del mundo entero). La ISO 13006 clasifica los azulejos de cerámica según el método de moldeo y la absorción de agua, y con respecto a cada grupo establece las características y los requisitos que definen a los azulejos de 1ª CALIDAD.

La norma EN 14411 ha sido publicada por el CEN (Comité Europeo de Normalización) y recoge en el apéndice ZA la parte «armonizada», que constituye el instrumento para la aplicación del marcado CE de conformidad con lo establecido en el vigente Reglamento del Parlamento europeo sobre la comercialización de los productos del ramo de la construcción. El marcado CE es obligatorio para la circulación de los azulejos dentro de la UE; se refiere a los azulejos de todas las clases comerciales y tiene en cuenta únicamente los requisitos fundamentales de "seguridad" con arreglo al uso al que estén destinados según lo declarado por el fabricante".

Todos los productos de Emilceramica cuentan con el marcado CE y son clasificados según el uso al que estén destinados tras superar las pruebas iniciales y periódicas establecidas por la norma UNI EN 14411 en su vigente versión.

Las normas UNI EN ISO 10545/1-16 proporcionan los métodos de prueba y de muestreo destinados a verificar las características establecidas por las normas ISO 13006 y UNI EN 14411.

Нормы ISO (Международная организация по стандартизации) приняты и опубликованы во всех странах-участницах (более 150 стран во всем мире). ISO 13006 классифицирует керамическую плитку на основании метода формовки и поглощения воды, и для каждой группы определяет характеристики и требования к плитке 1-ого СОРТА.

Стандарт EN 14411 был издан CEN (Европейским комитетом по нормализации) в октябре 2012 года и в приложении ZA приводит «гармонизированную» часть, в соответствии с которой на стройматериалы наносится маркировка CE, согласно действующему Регламенту Европарламента по торговле строительными материалами. Маркировка CE является обязательной для обращения плитки в пределах границ ЕС, распространяется на все продаваемые сорта и охватывает лишь только основные требования безопасности в соответствии со сферой назначения, заявленной производителем.

Вся продукция Emilceramica имеет маркировку CE и классифицируется по ее назначению, после прохождения начальных и периодических испытаний, предусмотренных нормой UNI EN 14411 в текущем ее варианте.

Нормы UNI EN ISO 10545/1-16 предоставляют методы испытания и отбора образцов для проверки характеристик, установленных нормой ISO 13006 и UNI EN 14411.

ISO 13006/UNI EN 14411 E UNI EN ISO 10545/1-16

CARATTERISTICHE TECNICHE GENERALI SECONDO LE NORME

General technical specifications in compliance with standards | Caracteristiques techniques generales selon les normes

Allgemeine technische eigenschaften nach den normen | Caracteristicas tecnicas generales conformes con las normas | Общие технические характеристики по нормам

Le piastrelle in ceramica, sono classificate in gruppi dalle norme citate in precedenza, in base al metodo di formatura ed al loro assorbimento d'acqua:

Ceramic tiles are classified in groups by the abovementioned standards according to the forming method and their water absorption:

Les normes susvisées classent en groupes les carreaux et dalles céramiques selon la méthode de fabrication et l'absorption d'eau :

Keramische Fliesen werden gemäß den oben genannten Normen auf der Grundlage des Formgebungsverfahrens und der Wasseraufnahme in Gruppen eingeteilt:

Los azulejos de cerámica están clasificados en grupos con arreglo a las citadas normas según el método de moldeo y la absorción de agua:

Керамическая плитка классифицируется указанными выше нормами по группам на основе метода формовки и поглощения воды:

GRUPPO A - GROUP A - GROUPE A- GRUPPE A - GRUPO A - ГРУППА "А"

- Piastrelle estruse, ossia foggiate allo stato plastico in un estrusore, quindi tagliate in dimensioni prefissate.
- Extruded tiles; i.e., plastic making in an extruder and then cut into set lengths.
- Carreaux étirés ou extrudés, c'est-à-dire dont la masse est façonnée à l'état plastique dans une étireuse, puis découpés en des carreaux de dimensions prédéterminées.
- Stranggepresste Fliesen. Herstellung durch Formung eines Stranges aus einer plastischen Masse mit Hilfe einer Strangpresse und anschließendes Abschneiden von Teilen in der vorgegebenen Größe.
- Azulejos extruidos —es decir, azulejos cuya masa es moldeada en estado plástico en un extrusor— y a continuación cortados en medidas establecidas previamente.
- Экструдированная плитка, то есть, сформованная в пластичном состоянии в экструдере, затем разрезанная на необходимые размеры.

GRUPPO B - GROUPE B - GRUPPE B - GRUPO B - ГРУППА "В"

- Piastrelle pressate a secco, ottenute partendo dalle materie prime in polvere o piccoli grani e foggiate in stampi a pressione elevata.
- Dry-pressed tiles, obtained from raw materials in the form of a powder or small grains and within high pressure moulds.
- Carreaux pressés à sec, dont la masse, à l'état de poudre ou de fins grains, est façonnée dans des moules sous pression élevée.
- Trockengepresste Fliesen. Herstellung aus Rohstoffen in Pulver- oder Granulatform, die unter hohem Druck in Formen gepresst werden.
- Azulejos prensados en seco que se fabrican a partir de materias primas en polvo o en gránulos y que son conformados en moldes a alta presión.
- Плитка сухого прессования, полученная исходя из порошкового сырья или мелких гранул и сформованная в пресс-формах при высоком давлении







Assorbimento d'acqua Water absorption Absorption d'eau Wasseraufnahme Поглощение воды	E ≤ 0,5%		0,5% < E ≤ 3%		3% < E ≤ 6%		6% < E ≤ 10%		E > 10%	
	Gruppo Group Groupe Gruppe Группа	A	Gruppo Group Groupe Gruppe Группа	Alb	Gruppo Group Groupe Gruppe Группа	Alla	Gruppo Group Groupe Gruppe Группа	Allb	Gruppo Group Groupe Gruppe Группа	Alll
A	Gruppo Group Groupe Gruppe Группа	A	Gruppo Group Groupe Gruppe Группа	Alb	Gruppo Group Groupe Gruppe Группа	Alla	Gruppo Group Groupe Gruppe Группа	Allb	Gruppo Group Groupe Gruppe Группа	Alll
B	Gruppo Group Groupe Gruppe Группа	Bla	Gruppo Group Groupe Gruppe Группа	Blb	Gruppo Group Groupe Gruppe Группа	Blla	Gruppo Group Groupe Gruppe Группа	Bllb	Gruppo Group Groupe Gruppe Группа	Blll

NORME ISO E ASTM

ISO STANDARDS - NORMES ISO - ISO NORMEN - NORMAS ISO - НОРМЫ ISO

Dry-Pressed Ceramic Tiles - ISO 13006 Annex G - UNI EN 14411 Annex G - Bla GL

Dry-Pressed Ceramic Tiles - ISO 13006 Annex G - UNI EN 14411 Annex G - Bla UGL (**Be-Square**)

CARATTERISTICHE TECNICHE Technical Features - Caracteristiques Techniques - Technische Eigenschaften Technische Eigenschaften - Caracteristicas Tecnicas - Технические Характеристики	NORMA Standard - Norme Norm - Norma - Норма	VALORI Value - Valeur Vorgabe - Valor - Средние		
 ASSORBIMENTO D'ACQUA (VALORE MEDIO IN %) Water absorption (Average value expressed in %) Absorption d'eau (Valeur moyenne en %) Wasseraufnahme (Durchschnittswert in %) Absorción de agua (Valor medio en %) Поглощение воды	UNI EN ISO 10545/3	Conforme		
	ASTM C373	Compliant		
 RESISTENZA ALLA FLESSIONE Modulus of rupture - Resistance a la flexion - Biegefestigkeit Resistencia a la flexion - Прочность на изгиб	Spessore - Thickness - Épaisseur - Dicke - Espesor - Толщина UNI EN ISO 10545/4	6,5 mm	8,5/9 mm 9,5 mm 10,5 mm	20 mm
FORZA DI ROTTURA Breaking strength - Résistance à la rupture - Bruchlast Resistencia a la rotura - Разрывное усилие	UNI EN ISO 10545/4	≥ 35 N/mm ²	≥ 45 N/mm ²	≥ 45 N/mm ²
	ASTM C648	250 Lbs	400 Lbs	2500 Lbs
 RESISTENZA AL GELO Frost resistance - Résistance au gel - Frostbeständigkeit Resistencia a las heladas - Морозостойкость	UNI EN ISO 10545/12	Conforme		
	ASTM C1026	Unaffected		
 RESISTENZA CHIMICA AD ALTE E BASSE CONCENTRAZIONI DI ACIDI E BASI Chemical resistance to high and low acid and basic concentrations Résistance chimique aux hautes et basses concentrations d'acides et de bases Chemikalienfestigkeit bei hohen und niedrigen Konzentrationen von Säuren und Basen Resistencia química con concentraciones altas y bajas de ácidos y bases Химическая стойкость к высоким и низким концентрациям кислот и щелочей	UNI EN ISO 10545/13	A - LA - HA		
	ASTM C-650	Unaffected		
 RESISTENZA ALLE MACCHIE Stain resistance - Résistance aux taches - Fleckenbeständigkeit Resistencia a las manchas - Стойкость к образованию пятен	UNI EN ISO 10545/14	5		
 COEFFICIENTE DI ATTRITO Slip resistance Coefficient de glissement Rutschfestigkeit Barfußbereich Coeficiente de atrito medio Коэффициент трения	DIN 51130 DIN 51097 DCOF B.C.R.A. Pendolo AS 4586 Pendolo BS 7976 Pendolo UNE 41901	Vedi pagine collezione all'interno del catalogo See collection pages in catalogue Voir les pages relatives à la collection dans le catalogue Siehe Kollektion im Katalog Consulta las páginas de la colección en el catálogo Смотри коллекцию на отдельных страницах каталога		

SHADE VARIATION

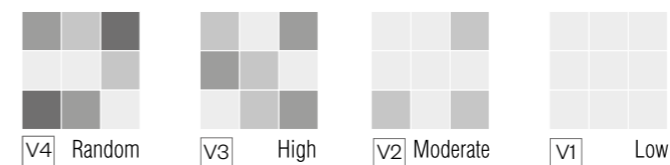



Il marchio "Ceramics of Italy" è il marchio dell'industria ceramica italiana che identifica i prodotti di ceramica MADE IN ITALY ed il sistema di valori sociali, ecologici ed estetici che la contraddistinguono. L'Italia è un paese di antiche tradizioni ceramiche, che hanno saputo rivivere e rinnovarsi nella moderna produzione industriale. Il marchio "Ceramics of Italy" intende valorizzare questo importante patrimonio storico, culturale e produttivo.



放射性水平A类

La certificazione CCC (China Compulsory Certificate), introdotta nel 2005, è obbligatoria per l'esportazione delle piastrelle in gres porcellanato in Cina ed è rilasciata esclusivamente da Enti di Certificazione accreditati dalle Autorità cinesi. Le caratteristiche oggetto della certificazione CCC riguardano in generale la sicurezza e la salute dell'utilizzatore finale.



PRODUCT CERTIFIED FOR LOW CHEMICAL EMISSIONS: UL.COM/GG UL 2818

Il processo di certificazione GREENGUARD garantisce una verifica e un'analisi approfondite delle emissioni chimiche rilasciate dai prodotti dei diversi fabbricanti. I prodotti vengono sottoposti a test in camera climatica dinamica per valutare la presenza di composti organici volatili (COV), quali la formaldeide e altri 300 COV soggetti a limiti di sicurezza per le emissioni. I prodotti certificati GREENGUARD contribuiscono alla creazione di ambienti interni più salubri e rilasciano meno inquinanti in grado di causare problemi alla salute, come l'asma e altre patologie respiratorie. Per poter mantenere questa certificazione, i prodotti vengono sottoposti a test certificativi completi su base annua, garantendo così ai clienti la massima tranquillità in merito alla scelta di un prodotto che tuteli la salute.

Riconosciuta e referenziata da oltre 400 codici, sistemi di classificazione e protocolli di fornitura in tutto il mondo, la certificazione GREENGUARD richiede che i prodotti rispettino alcuni dei limiti più completi e restrittivi adottati a livello internazionale per la riduzione dei COV negli ambienti interni. Lo standard GREENGUARD Gold prevede limiti di sicurezza anche per altre sostanze chimiche e richiede un livello inferiore di emissioni totali di COV per garantire che i prodotti siano idonei all'utilizzo in ambienti quali scuole e strutture sanitarie. Oltre a limitare le emissioni di più di 360 COV e le emissioni chimiche totali, i prodotti certificati GREENGUARD Gold devono rispettare anche i requisiti del "Metodo standard per l'analisi e la valutazione delle emissioni di composti organici volatili" adottato dal Dipartimento della salute pubblica dello stato della California (noto anche come protocollo California Section 01350).



La mindful MATERIALS Library è un'iniziativa sviluppata dal settore delle costruzioni per il settore delle costruzioni, con il coinvolgimento di una pluralità di soggetti. Si tratta di una piattaforma comune volta a promuovere la comunicazione trasparente e l'accesso a informazioni ottimizzate sui materiali per le costruzioni. mindful MATERIALS permette ai team di progetto e ai professionisti del settore di eseguire ricerche su un elevato numero di prodotti certificati. L'iniziativa offre ai professionisti la possibilità di individuare i prodotti più adatti a soddisfare le esigenze dei loro clienti o di progetti specifici. La mindful MATERIALS Library ha lo scopo di sostenere i professionisti nelle loro pratiche quotidiane, promuovendo il rispetto dell'ambiente e della salute nella scelta dei materiali per le costruzioni e nella progettazione, per ridurre l'impatto ambientale delle costruzioni.



Per semplificare l'attuale scenario della certificazione nel settore delle costruzioni, massimizzare la leggibilità dei benchmark per la qualità, le prestazioni e l'affidabilità di prodotti, servizi e parti interessate, il Centro Scientifique et Technique du Bâtiment - CSTB - ha lanciato il nuovo marchio QB - Qualité du bâtiment (qualità delle costruzioni). Questo nuovo marchio di certificazione sostituirà gradualmente i marchi CSTBat, CSTBat Service, Certifié CSTB e UPEC CSTB. Unificante e guidato da una potente comunicazione, QB contribuirà a rafforzare la reputazione del know-how, degli strumenti e delle soluzioni sviluppati dai players nel settore delle costruzioni, in Francia dal 2015 e a livello internazionale dal 2016. La certificazione dei prodotti "Piastrelle per pavimenti" si evolve dal marchio NF-UPEC verso il marchio QB-UPEC.

Da Maggio 2017 tutti i prodotti Emilceramica-Ergon-Viva, certificati UPEC sono stati contrassegnati con il nuovo marchio QB-UPEC, la cui classificazione attesta la conformità delle pavimentazioni ai requisiti tecnici stabiliti nei documenti di riferimento della certificazione. Il "classement QB-UPEC" indica che la durabilità di un prodotto è appropriata alla destinazione d'uso identificata per specifici locali.



The "Ceramics of Italy" mark is the mark of the Italian ceramics industry which identifies products that are MADE IN ITALY, with all the system of social, environmental and stylistic values this implies. Italy is a country with a historic tradition in the manufacture of ceramics, which has been renewed and given new life in modern industrial production. The "Ceramics of Italy" mark is intended to promote and emphasise the value of this impressive historic, cultural and manufacturing heritage.



放射性水平A类

CCC (China Compulsory Certificate) certification, introduced in 2005, is compulsory for the exportation of porcelain tiles to China and is only issued by Certification Bodies accredited by the Chinese authorities. In general, the characteristics covered by CCC certification relate to the health and safety of the end user.



PRODUCT CERTIFIED FOR LOW CHEMICAL EMISSIONS: UL.COM/GG UL 2818

The GREENGUARD Certification process provides an in-depth review and analysis of chemical emissions from manufacturers' products. Using dynamic environmental chamber testing, products are tested for volatile organic compounds (VOCs), including formaldehyde, and over 300 other VOCs with health-based limits. GREENGUARD Certified products aid in the creation of healthier indoor environments, and release fewer pollutants that can contribute to health issues including asthma and other respiratory issues. To remain certified, products undergo comprehensive certification testing on an annual basis, giving consumers peace of mind that they are selecting products that support better human health.

Recognized and referenced by over 400 codes, rating systems, and procurement policies worldwide, the GREENGUARD Certification requires that products meet some of the world's most rigorous and comprehensive limits for low emissions of volatile organic compounds into indoor environments. The GREENGUARD Gold standard includes health-based criteria for additional chemicals and requires lower total VOC emissions levels to ensure that products are acceptable for use in environments such as schools and healthcare facilities. In addition to limiting emissions of more than 360 VOCs and total chemical emissions, GREENGUARD Gold Certified products must also comply with requirements of the State of California's Department of Public Health "Standard Method for the Testing and Evaluation of Volatile Organic Chemical Emissions from known as California Section 01350.



The mindful MATERIALS Library is a multi-stakeholder initiative developed by the building industry for the building industry, providing a common platform to access and clearly communicate transparency and optimization information for building products. mindful MATERIALS allows project teams and industry professionals to search for a multitude of relevant, qualified products. It gives practitioners the capacity to find products that best meet individual project or client requirements. The mindful MATERIALS library aims to support standard daily practices, driving building materials and projects to consider human health and environmental impacts of products in the built environment.



To simplify the current situation concerning construction industry certification and maximise the legibility of benchmarks relating to the quality, performance and reliability of products, services and interested parties, the Centre Scientifique et Technique du Bâtiment - CSTB - has launched the new QB - Qualité pour le Bâtiment (building quality) mark. This new certification mark will gradually replace the CSTBat, CSTBat Service, Certifié CSTB Certified and UPEC CSTB marks. A unifying force and supported by powerful communications, the QB mark will help to reinforce the standing of the know-how, tools and solutions developed by construction industry players, in France from 2015 and internationally from 2016. "Floor tile" product certification will evolve from the NF-UPEC mark to the QB-UPEC mark.

With effect from May 2017, all UPEC-certified Emilceramica-Ergon-Viva products carry the new QB-UPEC mark, certifying floor tiles' compliance with the technical requirements established in the certification standard documents. The "classement QB-UPEC" indicates that a product's durability is appropriate to its intended use, identified by specific rooms.

CERTIFICATIONS



Ceramics of Italy

La marque "Ceramics of Italy" est la marque de l'industrie céramique italienne qui identifie les produits céramiques MADE IN ITALY, et le système de valeurs sociales, écologiques et esthétiques qui la distingue.

L'Italie est un pays de très anciennes traditions céramiques, qui ont su revivre et se renouveler dans la production industrielle moderne. La marque "Ceramics of Italy" entend valoriser cet important patrimoine historique, culturel et productif.



放射性水平A类

La certification CCC (China Compulsory Certificate), introduite en 2005, est obligatoire pour l'exportation des carreaux de grès cérame en Chine et est délivrée exclusivement par des Organismes de certification accrédités par les autorités chinoises. Les caractéristiques, objet de la certification CCC, concernent en général la sécurité et la santé de l'utilisateur final.



PRODUCT CERTIFIED FOR LOW CHEMICAL EMISSIONS: UL.COM/GG UL 2818

Le processus de certification GREENGUARD fournit une étude et une analyse approfondies des émissions chimiques libérées par les produits des différents fabricants.

Les produits passent des essais en chambre climatique dynamique pour détecter la présence de composés organiques volatils (COV), comme le formaldéhyde et plus de 300 autres COV présentant des limites sanitaires.

Les produits certifiés GREENGUARD contribuent à la création d'intérieurs plus sains et libèrent moins de polluants susceptibles d'entraîner des problèmes de santé, comme l'asthme et autres maladies respiratoires.

Pour maintenir leur certification, les produits doivent se soumettre à un test annuel de certification. Les clients sont ainsi certains de choisir un produit en mesure de protéger la santé.

Reconnue et référencée par plus de 400 codes, systèmes de classification et protocoles de fourniture dans le monde entier, la certification GREENGUARD exige que les produits respectent quelques-unes des limites les plus complètes et restrictives adoptées à l'échelle internationale pour réduire les COV de l'air intérieur.

Le label GREENGUARD Gold prévoit des limites de sécurité aussi pour d'autres substances chimiques et exige un niveau inférieur d'émissions totales de COV pour garantir la conformité des produits à l'emploi dans les applications, comme écoles et structures sanitaires. Non seulement les produits certifiés GREENGUARD Gold doivent limiter les émissions de plus de 360 COV et les émissions chimiques totales, mais ils doivent également respecter les critères de la « Méthode standard pour l'analyse et pour l'évaluation des émissions de composés organiques volatils » adoptée par le Département de la santé publique de l'État de la Californie (connue aussi sous le nom de « protocole California Section 01350 »).



Plusieurs organismes ont participé à la création de la mindful MATERIALS Library, initiative mise au point par le secteur des constructions pour le secteur des constructions. Cette plateforme commune vise à promouvoir la communication transparente et à fournir des informations meilleures sur les matériaux de construction. Avec mindful MATERIALS, les équipes de projet et les professionnels du secteur peuvent faire des recherches sur un très grand nombre de produits certifiés. L'initiative permet aux professionnels d'identifier les produits qui répondent le mieux aux exigences de leurs clients ou de projets spécifiques. La mindful MATERIALS Library a pour objectif d'aider les professionnels dans leur travail quotidien en choisissant, pour les constructions et les projets, des matériaux en mesure de protéger l'environnement et la santé et, par conséquent, de diminuer l'impact sur l'environnement.



Afin de simplifier le paysage actuel de la certification dans le domaine de la construction, d'optimiser la lisibilité des repères de qualité, de performance et de fiabilité des produits, des services et des acteurs, le Centre Scientifique et Technique du Bâtiment - CSTB - a lancé la nouvelle marque QB - Qualité pour le Bâtiment.

Cette nouvelle marque de certification se substituera progressivement aux marques CSTBat, CSTBat Service, Certifié CSTB Certified et UPEC CSTB. Fédératrice, portée par une communication puissante, QB contribuera à renforcer le rayonnement du savoir-faire, des outils et des solutions développés par les acteurs de la construction, en France dès 2015, et à partir de 2016 à l'international. La certification des produits « Carreaux céramiques pour revêtements de sol » évolue de la marque NF associée à

la marque UPEC, vers la marque QB associée au classement UPEC.

Depuis mai 2017, tous les produits Emilceramica-Ergon-Viva, certifiés UPEC, portent la nouvelle marque QB-UPEC, dont le classement atteste de la conformité des revêtements de sol à des spécifications techniques définies dans les référentiels de certification. Le « classement QB-UPEC » indique pour chaque produit que celui-ci est approprié à l'usage dans un local considéré, avec une durabilité suffisante et raisonnable.

ZERTIFIZIERUNGEN



Ceramics of Italy

"Ceramics of Italy" ist das Markenzeichen der italienischen Keramikindustrie. Es identifiziert keramische Erzeugnisse MADE IN ITALY und ist ein Gütesiegel, das auf sozialen, ökologischen und ästhetischen Werten basiert. Italien ist ein Land mit einer alten Keramiktradition, die sich perfekt den Möglichkeiten der modernen Industrieproduktion und dem Trend der Zeit angepasst hat. Die Marke "Ceramics of Italy" soll dieses geschichtliche und kulturelle Erbe sowie die ausgesprochen hohe Produktionsqualität verkörpern.



放射性水平A类

Die 2005 eingeführte Zertifizierung CCC (China Compulsory Certificate) ist für den Export von Feinsteinzeugfliesen nach China erforderlich und wird ausschließlich von Zertifizierungsstellen ausgestellt, die von chinesischen Behörden akkreditiert sind. Die der CCC-Zertifizierung zugrunde liegenden Güteanforderungen beziehen sich im Allgemeinen auf die Sicherheit und Gesundheit des Verbrauchers.



PRODUCT CERTIFIED FOR LOW CHEMICAL EMISSIONS: UL.COM/GG UL 2818

Der Zertifizierungsprozess GREENGUARD gewährleistet eine umfassende Prüfung und Analyse der chemischen Emissionen, die von Produkten unterschiedlicher Hersteller freigesetzt werden.

Im Rahmen dynamischer Tests in Klimakammern werden die Produkte auf flüchtige organische Verbindungen (VOC) geprüft, darunter Formaldehyd und weitere 300 VOCs, für die Grenzwerte in Bezug auf ihre Emissionen gelten. Die nach GREENGUARD zertifizierten Produkte leisten einen Beitrag zur Steigerung der Wohnqualität von Innenräumen, da sie deutlich weniger Schadstoffe abgeben, die Gesundheitsprobleme wie Asthma oder andere Atemwegserkrankungen verursachen können.

Um diese Zertifizierung aufrecht erhalten zu können, werden die Produkte jedes Jahr vollständigen Zertifizierungsprüfungen unterworfen, die den Kunden die bestmögliche Sicherheit für ein gesundheitsverträgliches Produkt geben. Die in über 400 Vor-

schriften, Klassifizierungssystemen und Lieferprotokollen in der ganzen Welt anerkannte und als Bezugsnorm verwendete Zertifizierung GREENGUARD verlangt, dass die Produkte einige der weltweit vollständigsten und strengsten Grenzwerte zur Verringerung von VOC-Emissionen im Innenbereich erfüllen.

Der Standard GREENGUARD Gold legt außerdem Grenzwerte für weitere chemische Stoffe fest und fordert ein niedrigeres Niveau der VOC-Gesamtemissionen, und sorgt dafür, dass die Produkte auch in Gebäuden wie Schulen und medizinischen Einrichtungen eingesetzt werden können. Neben der Einhaltung von Grenzwerten für über 360 VOCs sowie der Beschränkung der Summe sämtlicher chemischer Emissionen, müssen die nach dem GREENGUARD Gold Standard zertifizierten Produkte auch die Anforderungen erfüllen, die in der „Standardmethode für die Analyse und Bewertung der Emissionen flüchtiger organischer Verbindungen“ definiert sind, die von der Gesundheitsbehörde des US-Bundesstaates Kalifornien definiert wurden (auch als Kalifornien-Protokoll Abschnitt 01350 bekannt).



Die Initiative mindful MATERIALS Library wurde von der Baubranche für die Baubranche unter Einbeziehung etlicher Partner ins Leben gerufen. Es handelt sich um eine gemeinsame Plattform zur Förderung einer transparenten Kommunikation und optimierter Informationen über Baustoffe. mindful MATERIALS bietet Planungsteams und Branchenspezialisten die Möglichkeit, Recherchen zu einer Vielzahl von zertifizierten Produkten durchzuführen. Die Initiative hilft ihnen bei der Identifizierung der Produkte, die den Anforderungen ihrer Auftraggeber oder spezieller Projekte am besten gerecht werden. Die mindful MATERIALS Library soll die Spezialisten in ihrem Arbeitsalltag mit einem besonderen Fokus auf den Umwelt- und Gesundheitsschutz bei der Wahl der Baustoffe und bei ihren planerischen Tätigkeiten zur Gestaltung von nachhaltigen Bauwerken unterstützen.



Das Centre Scientifique et Technique du Bâtiment (CSTB, Wissenschaftliches und technisches Zentrum für Bauwesen) hat das neue Zertifizierungslabel QB - Qualität für das Bâtiment (Bauqualität) geschaffen. Es dient der Vereinfachung des aktuellen Zertifizierungswesens in der Baubranche und soll die Benchmarks für Qualität, Performance und Zuverlässigkeit von Produkten, Dienstleistungen und Beteiligten deutlicher herausstellen.

Das neue Label wird schrittweise die Labels CSTBat, CSTBat Service, Certifié CSTB Certified und UPEC CSTB ablösen. Das vereinheitlichende QB-Logo gilt in Frankreich seit 2015 und weltweit seit 2016. Aufbauend auf eine starke Kommunikation soll es das Image von Knowhow, Tools und Lösungen der Baubranche stärken. An die Stelle des Zertifizierungslabels NF-UPEC für die

Produkte „Bodenfliesen“ wird daher das Logo QB-UPEC treten.

Seit Mai 2017 sind alle UPEC-klassifizierten Produkte von Emilceramica-Ergon-Viva mit dem neuen Logo QB-UPEC gekennzeichnet, das ihre Übereinstimmung mit den technischen Zertifizierungsanforderungen bescheinigt. Die QB-UPEC-Klassifizierung gibt an, dass die Eigenschaften eines Produkts für die Zweckbestimmung der jeweiligen Räumlichkeit geeignet sind.



“Ceramics of Italy” es la marca de la industria cerámica italiana que identifica los productos MADE IN ITALY, pero también es el sistema de valores sociales, ecológicos y estéticos que la caracteriza. Italia es un país de antiguas tradiciones cerámicas, que han sabido revivir y renovarse en la moderna producción industrial. La marca “Ceramics of Italy” busca valorizar este importante patrimonio histórico, cultural y productivo.



放射性水平A类

La certificación CCC (China Compulsory Certificate), introducida en 2005, es obligatoria para la exportación de los azulejos de gres porcelánico a China y es otorgada exclusivamente por entidades de certificación acreditadas por las autoridades chinas. Las características objeto de la certificación CCC se refieren en general a la seguridad y la salud del usuario final.



PRODUCT CERTIFIED FOR LOW CHEMICAL EMISSIONS: UL.COM/GG UL 2818

El proceso de certificación GREENGUARD garantiza una revisión y un análisis exhaustivos de las emisiones químicas generadas por los productos de los varios fabricantes.

Los productos son sometidos a controles ambientales en una cámara climática para evaluar la presencia de compuestos orgánicos volátiles (COV), como el formaldehído y otros tóxicos, que pueden perjudicar la salud si sus emisiones sobrepasan determinados límites. Los productos avalados por la certificación GREENGUARD contribuyen a la creación de ambientes interiores más saludables y emiten menos sustancias contaminantes susceptibles de ocasionar problemas de salud tales como asma y otras patologías respiratorias.

Para poder mantener esta certificación, los productos han de ser sometidos a pruebas completas con periodicidad anual. De este modo los clientes tienen la seguridad de que el producto elegido va a salvaguardar su salud.

Reconocida e identificada por más de cuatrocientos códigos de referencia, sistemas de clasificación y protocolos de suministro en el mundo entero, la certificación GREENGUARD exige que los productos se atengan a algunos de los límites más rigurosos y completos del ámbito internacional para la reducción de los compuestos orgánicos volátiles en espacios interiores.

El estándar GREENGUARD Gold también establece límites de seguridad en relación con otras sustancias químicas y exige un nivel de emisiones totales aún más bajo si los productos se van a utilizar en lugares tales como escuelas y estructuras sanitarias. Además de limitar las emisiones de más de trescientos sesenta compuestos orgánicos volátiles y las emisiones químicas totales, los productos avalados por la certificación GREENGUARD Gold también tienen que cumplir los requisitos del “Método estándar de análisis y evaluación de las emisiones de compuestos orgánicos volátiles” adoptado por el Departamento de salud pública del estado de California (conocido asimismo como protocolo California Section 01350).



Mindful MATERIALS Library es una iniciativa desarrollada por y para la industria de la construcción, que ve involucrados a múltiples actores. Se trata de una plataforma común orientada a promover una comunicación clara y transparente y el acceso a una excelente información acerca de los materiales de la construcción. mindful MATERIALS facilita a los equipos de elaboración de proyectos y a los profesionales del sector la investigación acerca de un elevado número de productos certificados. La iniciativa ofrece a los profesionales la posibilidad de hallar los productos más adecuados para satisfacer las exigencias de sus clientes o de proyectos específicos. mindful MATERIALS Library se propone prestar apoyo a los profesionales en su quehacer diario, promoviendo la salvaguardia del medio ambiente y de la salud en la elección de los materiales de construcción y en la realización de proyectos, con el objeto de reducir el impacto medioambiental de las construcciones.



Para simplificar el escenario actual de la certificación en el sector de la construcción, maximizar la legibilidad de los puntos de referencia con respecto a la calidad, las prestaciones y la fiabilidad de los productos, servicios y partes involucradas, el Centre Scientifique et Technique du Bâtiment —CSTB— ha lanzado la nueva marca QB - Qualité pour le Bâtiment (calidad de los edificios).

Esta nueva marca de certificación substituirá gradualmente las marcas CSTBat, CSTBat Service, Certifié CSTB Certified y UPEC CSTB. Unificadora y guiada por una profusa comunicación, la marca QB contribuirá a reforzar la reputación del know-how, de las herramientas y de las soluciones desarrolladas por los actores en el sector de la construcción, en Francia desde 2015 y en el ámbito internacional desde 2016. La certificación de los productos “azulejos para pavimentos” evoluciona pasando de la marca NF-UPEC a la marca QB-UPEC.

Desde mayo de 2017 todos los productos Emilceramica-Ergon-Viva, certificados UPEC, se han señalado con la nueva marca QB-UPEC, cuya clasificación certifica la conformidad de las pavimentaciones con los requisitos técnicos establecidos en los documentos de referencia de la certificación. La clase QB-UPEC indica que la durabilidad de un producto resulta apropiada al uso que se le va a dar en locales específicos.



Ceramics of Italy

Марка “Ceramics of Italy” - это марка итальянской керамической промышленности, идентифицирующая керамическую продукцию “MADE IN ITALY” и систему отличающих ее социальных, экологических и эстетических ценностей. Италия - это страна с древними традициями в керамике, которые смогли пережить и возродиться в современном керамическом производстве. Марка “Ceramics of Italy” стремится к valorización этого важного исторического, культурного и производственного наследия.



放射性水平A类

Сертификация CCC (China Compulsory Certificate), введенная в 2005 году, необходима и обязательна для экспорта плитки из керамогранита в Китай и выдается лишь только сертифицирующими организациями, аккредитованными китайскими органами власти. Характеристики, являющиеся предметом сертификации CCC, касаются в основном безопасности и здоровья конечного пользователя.



PRODUCT CERTIFIED FOR LOW CHEMICAL EMISSIONS: UL.COM/GG UL 2818

Процесс выдачи сертификата GREENGUARD гарантирует, что сертифицируемая продукция подвергается тщательной проверке и анализу выделяемых химических веществ. Продукция проходит испытания в динамической климатической камере для определения присутствия таких летучих органических соединений (ЛОС), как формальдегид и еще 300 других ЛОС, для которых предусмотрены предельные значения выделения из-за их воздействия на здоровье. Продукция с сертификатом GREENGUARD способствует созданию здоровой среды в помещениях и выделяет меньше загрязнений, способных нанести ущерб здоровью человека, например, вызвать астму или другие заболевания органов дыхания.

Продукция ежегодно проходит полный спектр сертификационных испытаний для подтверждения соответствия требованиям, таким образом, потребители могут быть уверены в том, что выбранный сертифицированный товар является максимально безопасным для здоровья. Сертификат GREENGUARD признан во всем мире и на него дают отсылку более 400 стандартов, систем рейтинговых оценок и закупочных процедур, так как он требует, чтобы продукция соответствовала наиболее полным и жестким ограничениям, принятым на международном уровне для снижения ЛОС в замкнутых пространствах.

Для получения сертификата GREENGUARD Gold продукция должна соответствовать ограничениям также и по другим химическим веществам при меньшем уровне общих выделений ЛОС, таким образом, гарантируется ее пригодность для применения в таких уязвимых местах, как школы и медицинские учреждения. Помимо требований к выделению более 360 ЛОС и к общему количеству выделенных химических веществ продукция с сертификатом GREENGUARD Gold должна также соответствовать требованиям «Стандартного метода для анализа и оценки выделений летучих органических соединений», принятого Департаментом общественного здравоохранения штата Калифорния (также известного под названием California Section 01350 - Калифорнийский протокол, раздел 01350).



Библиотека mindful MATERIALS Library - это база данных, к созданию которой привлечены многочисленные участники, разработанная строительной отраслью для самой строительной отрасли. Речь идет об общей платформе, целью которой является поощрение ясной коммуникации и предоставление оптимизированной информации о строительных материалах. mindful MATERIALS позволяет проектным группам и специалистам этой отрасли подробно ознакомиться с большим количеством сертифицированных изделий. Эта база данных предоставляет специалистам возможность найти продукцию, наиболее точно отвечающую требованиям заказчиков или конкретных проектов. Библиотека mindful MATERIALS Library помогает ежедневной работе специалистов, поощряет уважительное отношение к природе и охране здоровья при выборе строительных материалов и проектировании в целях снижения отрицательного воздействия строительства на окружающую среду.



Для упрощения ситуации с сертификацией в сфере строительства, максимального понимания показателей качества, характеристик и надежности продукции, услуг и задействованных сторон, центр Centre Scientifique et Technique du Bâtiment - CSTB создал новый знак QB - Qualité pour le Bâtiment (качество строений). Этот новый сертификационный знак постепенно заменит собой знаки CSTBat, CSTBat Service, Certifié CSTB Certified и UPEC CSTB. Объединяющий и поддерживаемый мощной коммуникационной кампанией, QB внесет свой вклад в укрепление репутации ноу-хау, инструментов и решений, разработанных операторами в сфере строительства: во Франции - с 2015 года, а на международном уровне - с 2016 года. Сертификация NF-UPEC продукции «Напольная плитка» будет заменена знаком QB-UPEC.

С мая 2017 года вся сертифицированная по UPEC продукция Emilceramica-Ergon-Viva была маркирована новым знаком QB-UPEC, классификация которого подтверждает соответствие полов изложенным в справочных документах техническим требованиям. Классификация QB-UPEC означает, что долговечность изделия соответствует назначению, указанному для определенных помещений.

EMILCERAMICA

SLABS 6,5MM

MOVIMENTAZIONE IMBALLI E LASTRE

CASSE E CAVALLETTI

Per lo stoccaggio e il trasporto delle lastre nelle massime condizioni di sicurezza esistono specifiche tipologie di imballi:

- casse (in legno), le lastre vengono disposte in posizione orizzontale in apposite casse di legno, realizzate su misura
- cavalletti (in legno), le lastre vengono disposte in posizione verticale su apposite strutture di legno a forma di cavalletto, realizzate su misura, appositamente pensate per trasporto via container.

MOVIMENTAZIONE CASSE

Si raccomanda di movimentare le casse singolarmente e di verificare preventivamente che la portata del muletto sia idonea al peso da trasportare.

Per lo stoccaggio e solo nel caso in cui siano uguali tra loro, è possibile impilarle fino a un massimo di 8.

Movimentazione della Cassa

sul Lato Lungo

Si tratta dell'opzione più indicata per la movimentazione. Per eseguirla si raccomanda di usare forche della lunghezza minima di 1,2 m inforcando la cassa negli appositi fori appositamente predisposti nel lato lungo per una maggiore stabilità.

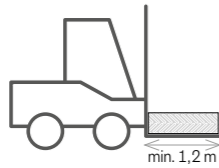

Movimentazione della Cassa

sul Lato Corto

Si tratta di un'operazione che deve essere effettuata unicamente per il carico/scarico dei container e per la quale si raccomanda l'utilizzo di forche della lunghezza minima di 2,1 m.

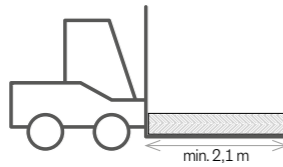

MOVIMENTAZIONE CAVALLETTI

Si raccomanda di movimentare il cavalletto singolarmente e di verificare preventivamente che la portata del muletto sia idonea al peso da trasportare.

Movimentazione del cavalletto

sul Lato Lungo

Si tratta dell'opzione più indicata per la movimentazione. Per eseguirla si raccomanda di usare forche della lunghezza minima di 1,2 m inforcando il cavalletto negli appositi fori appositamente predisposti sul lato lungo per una maggiore stabilità.

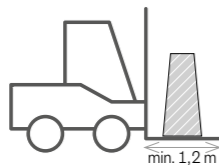

Movimentazione del cavalletto

sul Lato Corto

Si tratta di un'operazione che deve essere effettuata unicamente per il carico/scarico dei container e per la quale si raccomanda l'utilizzo di forche della lunghezza minima di 2,1 m.

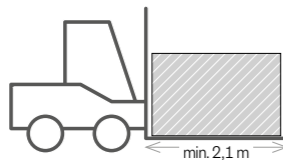

GLI STRUMENTI

Per tutte le operazioni di movimentazione delle lastre si raccomanda di usare gli strumenti appositamente pensati per i grandi formati ceramici.

Barre con ventose - Strumento composto da due coppie di profili di alluminio, collegate tra loro e che scorrono l'uno rispetto all'altro, dotate di una serie di ventose basculanti con vuotometro ideali anche per superfici strutturate. Applicando il dispositivo alla lastra se ne aumenta la rigidità permettendo di spostarla in condizioni di massima sicurezza.

Carrello - Struttura di alluminio dotata di ruote e ganci ad altezza regolabile atti a sostenere dispositivi di movimentazione; consente un più agile e sicuro spostamento delle lastre ed agevola l'azione della spalmatura del collante. Il suo utilizzo è inoltre strettamente raccomandato per il trasporto di lastre lavorate (es: con fori, tagli ad "L" e "C" etc.).

MOVIMENTAZIONE LASTRE

Per la movimentazione e conseguente estrazione delle lastre dagli imballi è possibile usare il kit di sollevamento delle lastre composto da telai in alluminio dotati di ventose.

Le lastre devono essere movimentate una per volta e con l'apporto di almeno due operatori (il numero degli operatori varia a seconda delle dimensioni e dello spessore della lastra da movimentare).

Le ventose di sollevamento devono essere posizionate sulla lastra, previa pulizia del punto di ancoraggio, in modo da garantirne l'equilibrio durante la movimentazione.

Le lastre devono essere sollevate con estrema cautela limitando il più possibile i movimenti oscillatori o le vibrazioni facendo estrema attenzione ai bordi.

Una volta estratte le lastre dall'imballo possono:

- Essere adagiate su un piano di lavoro orizzontale o su di un carrello per procedere a lavorazioni di taglio, foratura o spalmatura del collante: nel caso si proceda a lavorazioni la lastra deve essere posizionata con il fronte verso l'alto, nel caso di applicazione del collante la lastra deve essere riposta con il fronte verso il basso o verso l'interno del carrello.
- Essere appoggiate a terra, in tal caso si consiglia di farlo proteggendo i bordi.

SLABS 6,5MM

PACKAGING AND SLABS HANDLING

CRATES AND A-FRAMES.

Specific types of packaging are used to store and transport slabs with the maximum safety:

- Crates (in wood), slabs are placed horizontal in special, made-to-measure wooden crates
- A-frames (in wood), slabs are placed vertical on special, made-to-measure trestle-shaped wooden frames, especially designed for shipment in container.

HANDLING CRATES

Crates must be handled one at a time, checking in advance that the payload of the forklift used is suitable for the weight to be transported.

For storage, only if they are identical, they can be stacked in piles of up to 8.

Handling crates by the long side

This is the recommended handling option. Crates must be handled using forks at least 1.2 m long, inserted in the holes provided on the long side for greater stability.

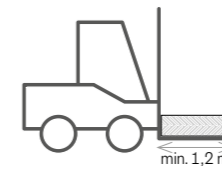

Handling Crates by the short side

This method must only be adopted for loading/unloading containers and forks at least 2.1 m long should be used.

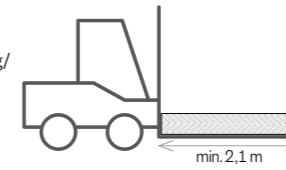

HANDLING A-FRAMES

A-frames must be handled one at a time, checking in advance that the payload of the forklift used is suitable for the weight to be transported.

Handling A-frames by the long side

This is the recommended handling option. A-frames must be handled using forks at least 1.2 m long, inserted in the holes provided on the long side for the maximum stability.

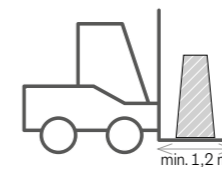

Handling A-frames by the short side

This method must only be adopted for loading/unloading containers and forks at least 2.1 m long should be used.

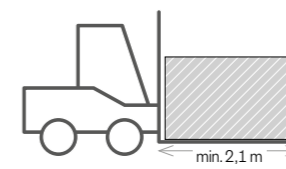

EQUIPMENT

When handling slabs, it is essential always to use the equipment specifically designed for use with large ceramic slabs.

Suction cup handling bars - Device consisting of two pairs of linked aluminium bars, sliding in relation to each other, with a series of swivel suction cups with vacuum metre, also ideal for structured surfaces. Applying this device to the slab increases its rigidity and allows it to be handled with the maximum safety.

Trolley - Aluminium structure with wheels and adjustable height hooks to support handling devices; allows more agile, safer handling of slabs and simplifies coating with adhesive.

Its use is also strictly recommended for transporting shaped slabs (e.g. with holes, "L" and "C" cuts, etc.).

HANDLING

Packs can be handled and extracted from the packaging using the slab lifting kit consisting of aluminium frames fitted with suction cups.

Slabs must be handled one at a time, by at least two operatives (the number of operatives varies depending on the size and thickness of the slab for handling). The lifting suction cups must be positioned on the slab (after cleaning of the connection point) in a way which ensures that it remains balanced during handling.

Slabs must be lifted with great care, minimising swaying or vibration and taking great care not to damage the edges.

Once extracted from the packaging, slabs may:

- Be placed on a horizontal work surface or trolley for cutting, drilling or coating with adhesive. For shaping, the slab must be positioned face upwards, while for coating, it must be placed with the face downwards or towards the middle of the trolley.
- Be placed on the ground, in which case the edges should be protected.

EMILCERAMICA

SLABS 6,5MM

MANUTENTION EMBALLAGES ET DALLES

CAISSES ET CHEVALETS DE TRANSPORT

Pour stocker et transporter les dalles dans les meilleures conditions de sécurité, des emballages spécifiques ont été mis au point :

- caisses (en bois), les dalles sont mises à l'horizontale dans des caisses spéciales en bois, faites sur mesure
- chevalets de transport (en bois), les dalles sont mises à la verticale sur des structures spéciales en bois, en forme de chevalet, faites sur mesure et conçues tout particulièrement pour le transport par conteneur.

MANUTENTION DES CAISSES

Il est recommandé de manipuler les caisses une par une et de vérifier au préalable que la capacité du chariot élévateur est compatible avec le poids à transporter.

Exclusivement dans le cas où les caisses sont toutes les mêmes, elles peuvent être stockées en les empilant jusqu'à un maximum de 8.

Manutention de la caisse côté long

Il s'agit de l'option la plus indiquée pour la manutention. Pour l'exécuter, il est recommandé d'utiliser des fourches de 1,2 m de long minimum et de soulever la caisse en la prenant par les trous prévus à cet effet, sur le côté long, pour une stabilité optimale.

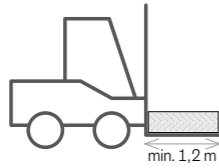

Manutention de la caisse côté court

Cette opération convient uniquement pour le chargement/déchargement des conteneurs. Il est recommandé d'utiliser des fourches de 2,1 m de long minimum.

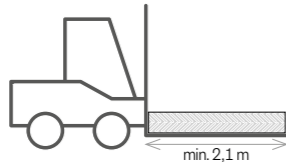

MANUTENTION DES CHEVALETS DE TRANSPORT

Il est recommandé de manipuler les chevalets un par un et de vérifier au préalable que la capacité du chariot élévateur est compatible avec le poids à transporter.

Manutention du chevalet côté long

Il s'agit de l'option la plus indiquée pour la manutention. Pour l'exécuter, il est recommandé d'utiliser des fourches de 1,2 m de long minimum et de soulever le chevalet en le prenant par les trous prévus à cet effet, sur le côté long, pour une stabilité optimale.

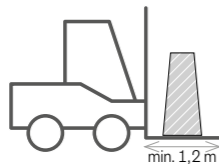

Manutention du chevalet côté court

Cette opération convient uniquement pour le chargement/déchargement des conteneurs. Il est recommandé d'utiliser des fourches de 2,1 m de long minimum.

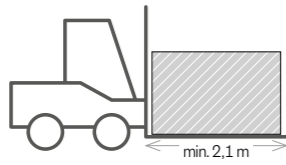

LES OUTILS

Il est recommandé de manipuler les dalles au moyen d'outils expressément conçus pour les grands formats céramiques.

Barres à ventouses - Outil constitué de deux paires de profilés aluminium, raccordés entre eux et coulissant l'un par rapport à l'autre, équipés d'une série de ventouses à tête basculante avec affichage du vide, idéales pour les surfaces structurées. Une fois l'outil appliqué sur la dalle, il augmente sa rigidité pour la déplacer en toute sécurité.

Chariot - Structure aluminium avec roues et crochets réglables en hauteur, pour soutenir le matériel de manutention. Il assure un déplacement des dalles plus simple et plus sûr, et il facilite l'application de la colle. Son emploi est formellement recommandé pour la manutention des dalles façonnées (ex : percées, découpées en L ou C, etc.).

MANUTENTION

Pour manutentionner et débarrer les dalles, il est possible d'utiliser le kit de levage composé de cadres aluminium à ventouses.

Les dalles doivent être manipulées une par une par deux opérateurs au moins (le nombre d'opérateurs dépend des dimensions et de l'épaisseur de la dalle). Les ventouses de levage doivent être positionnées sur la dalle, après avoir nettoyé le point d'ancrage, pour en garantir l'équilibre au cours de la manutention. Les dalles doivent être soulevées avec la plus grande précaution, en limitant au minimum les balancements et les vibrations et en faisant extrêmement attention aux bords.

Après déballage, les dalles peuvent :

- Être posées sur un plan de travail horizontal ou sur un chariot pour passer aux opérations de coupe, perçage ou application de la colle. Pour tout façonnage, la dalle doit être déposée face avant vers le haut. Pour l'application de colle, la dalle doit être déposée face avant vers le bas ou vers l'intérieur du chariot.
- Être posées par terre. Dans ce cas, protéger les bords.

SLABS 6,5MM

VERPACKUNG UND PLATTEN HANDHABUNG

KISTEN UND TRANSPORTGESTELLE

Für ein Höchstmaß an Sicherheit bei Lagerung und Transport der Platten werden spezielle Verpackungstypen angeboten:

- Kisten (aus Holz): die Platten werden liegend in maßgefertigten Kisten verpackt
- Transportgestelle (aus Holz): die Platten werden stehend in speziell gefertigten Transportgestellen aus Holz für den Containertransport verpackt.

HANDHABUNG DER KISTEN

Die Kisten sollten einzeln gehandhabt werden. Vorher sicherstellen, dass die Tragkraft des Staplers für das Gewicht der zu transportierenden Last geeignet ist.

Für die Lagerung beträgt die maximale Stapelhöhe 8 Kisten, sofern die Kisten gleich sind.

Lastaufnahme der Kiste von der Längsseite

Es handelt sich um die geeignetste Lösung für die Handhabung. Dabei sollten Gabelzinken mit einer Länge von mindestens 1,2 m verwendet werden. Die Kiste wird durch Einfahren der Gabelzinken in die vorgesehenen Aussparungen auf der Längsseite aufgenommen, um eine bessere Stabilität zu erzielen.

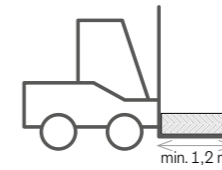

Lastaufnahme der Kiste von der Kurzseite

Dieser Vorgang ist nur zum Be-/Entladen der Container zulässig. Dabei sollten Gabelzinken mit einer Länge von mindestens 2,1 m verwendet werden.

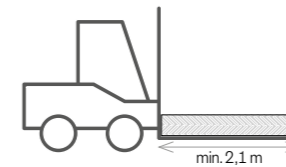

HANDHABUNG DER TRANSPORTGESTELLE

Die Transportgestelle sollten einzeln gehandhabt werden. Vorher sicherstellen, dass die Tragkraft des Staplers für das Gewicht der zu transportierenden Last geeignet ist.

Lastaufnahme des Transportgestells von der Längsseite

Es handelt sich um die geeignetste Lösung für die Handhabung. Dabei sollten Gabelzinken mit einer Länge von mindestens 1,2 m verwendet werden. Das Transportgestell wird durch Einfahren der Gabelzinken in die vorgesehenen Aussparungen auf der Längsseite aufgenommen, um eine bessere Stabilität zu erzielen.

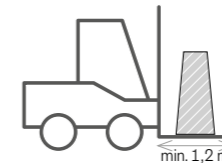

Lastaufnahme des Transportgestells von der Kurzseite

Dieser Vorgang ist nur zum Be-/Entladen der Container zulässig. Dabei sollten Gabelzinken mit einer Länge von mindestens 2,1 m verwendet werden.

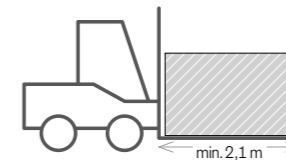

ARBEITSMITTEL

Für alle Arbeitsschritte im Zusammenhang mit der Handhabung der Platten wird empfohlen, die für großformatige Keramikerzeugnisse eigens vorgesehenen Arbeitsmittel zu verwenden.

Handlingerät mit Saugtellern - Gerät, bestehend aus zwei miteinander verbundenen und gegenseitig verschiebbaren Aluprofil-Paaren, die mit verstellbaren Saugtellern und Vakuummeter bestückt sind und sich auch zur Aufnahme strukturierter Platten eignen. Beim Anlegen des Geräts an die Platte erhöht sich deren Steifigkeit, wodurch sie unter absolut sicheren Bedingungen transportiert werden kann.

Transportwagen - Der Wagen besteht aus einem fahrbaren Alugestell und ist mit höhenverstellbaren Haken zum Fixieren von Handlingeräten ausgestattet. Er ermöglicht es, Platten bequemer und sicherer zu transportieren und erleichtert das Auftragen des Klebemörtels. Der Wagen sollte auch unbedingt verwendet werden, wenn bearbeitete Platten (z.B. mit Bohrungen, L- oder C-förmige Ausschnitten, usw.) zu transportieren sind.

HANDHABUNG

Zur Handhabung und Entnahme der Platten aus den Verpackungen kann das aus Alu-Schienen und Saugtellern bestehende Handlingerät verwendet werden. Die Platten müssen jeweils einzelnen und von mindestens zwei Personen (die Zahl der Personen hängt von der Größe und Stärke der Platte ab) gehandhabt werden.

Bevor die Saugteller an der Platte angebracht werden, ist der Spannungsbereich zu reinigen, um die Laststabilität während der Handhabung zu gewährleisten. Die Platten sind mit größter Vorsicht zu heben. Schwenkbewegungen oder Schwingungen nach Möglichkeit vermeiden und unbedingt auf die Kanten achten.

Nach ihrer Entnahme aus der Verpackung können die Platten:

- auf eine horizontale Arbeitsfläche gelegt oder auf einen Transportwagen geladen werden, um Schneid- bzw. Bohrbearbeitungen oder den Kleberauftrag vorzunehmen. Die Platte mit nach oben gerichteter Sichtseite positionieren, wenn Bearbeitungen anstehen und mit nach unten bzw. zum Wageninneren gerichteter Sichtseite, wenn Klebemörtel aufgebracht werden soll.
- auf den Boden gelegt werden, wobei man in diesem Fall die Kanten schützen sollte.

EMILCERAMICA

SLABS 6,5MM

DESPLAZAMIENTO EMBALAJES Y PLACAS

CAJAS Y CABALLETES

Para el almacenaje y el transporte de las placas en condiciones de máxima seguridad, existen tipos de embalajes específicos:

- cajas (de madera): las placas se colocan en posición horizontal dentro de cajas de madera especiales, realizadas a medida
- caballetes (de madera): las placas se colocan en posición vertical sobre estructuras de madera especiales, en forma de caballete, realizadas a medida y diseñadas específicamente para el transporte en contenedores.

DESPLAZAMIENTO DE CAJAS

Es aconsejable desplazar las cajas por separado, tras comprobar que la carretilla elevadora tiene una capacidad de carga idónea para el peso que se va a transportar. Para su almacenaje, y únicamente si son iguales unas a otras, es posible apilarlas hasta un máximo de 8 unidades.

Desplazamiento de la caja por el lado largo

Es la opción más adecuada para el desplazamiento. Para llevarla a cabo, es aconsejable utilizar horquillas con una longitud mínima de 1,2 m e introducirlas en las aberturas correspondientes situadas en el lado largo de la caja, ya que ofrecen mayor estabilidad.

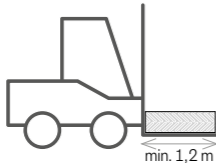

Desplazamiento de la caja por el lado corto

Esta operación debe realizarse únicamente para cargar/descargar el contenedor; para llevarla a cabo, se recomienda utilizar horquillas con una longitud mínima de 2,1 m.

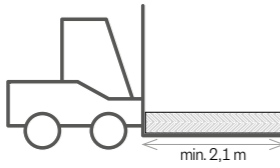

DESPLAZAMIENTO DE CABALLETES

Es aconsejable desplazar los caballetes por separado, tras comprobar que la carretilla elevadora tiene una capacidad de carga idónea para el peso que se va a transportar.

Desplazamiento del caballete por el lado largo

Es la opción más adecuada para el desplazamiento. Para llevarla a cabo, es aconsejable utilizar horquillas con una longitud mínima de 1,2 m e introducirlas en las aberturas correspondientes situadas en el lado largo del caballete, ya que ofrecen mayor estabilidad.

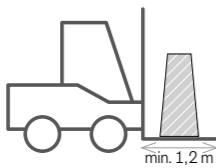

Desplazamiento del caballete por el lado corto

Esta operación debe realizarse únicamente para cargar/descargar el contenedor; para llevarla a cabo, se recomienda utilizar horquillas con una longitud mínima de 2,1 m.

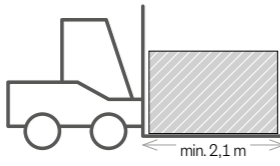

HERRAMIENTAS

Para todas las operaciones de desplazamiento de las placas, se recomienda usar herramientas diseñadas específicamente para los formatos cerámicos grandes.

Barras con ventosas - Herramienta formada por dos pares de perfiles de aluminio, conectados entre sí, que se desplazan uno respecto de otro, dotados de una serie de ventosas basculantes con vacuómetro, idóneas también para superficies estructuradas. Cuando se coloca el dispositivo en la placa, se aumenta su rigidez, de manera que es posible desplazarla en condiciones de máxima seguridad.

Caballete con ruedas - Estructura de aluminio dotada de ruedas y ganchos de altura ajustable, idóneos para sostener dispositivos de desplazamiento. Permite desplazar las placas de forma más cómoda y segura, y facilita la distribución del adhesivo. Se aconseja vivamente su uso también para transportar placas mecanizadas (p. ej.; con orificios, cortes en forma de «L» y «C», etc.).

DESPLAZAMIENTO

Para desplazar y posteriormente extraer las placas de su embalaje, es posible utilizar el kit de elevación de placas, formado por bastidores de aluminio dotados de ventosas. Las placas deben manipularse una a la vez, como mínimo por dos operadores (el número de operadores cambia en función del tamaño y el grosor de la placa que se va a desplazar). Las ventosas de elevación deben colocarse en la placa, tras limpiar el punto de aplicación, a fin de garantizar su equilibrio durante el desplazamiento. Las placas deben levantarse con mucho cuidado, limitando al máximo los movimientos oscilatorios y las vibraciones, y prestando grandísima atención a los bordes.

Una vez extraídas las placas del embalaje, es posible:

- colocarlas sobre una superficie de trabajo horizontal o un caballete con ruedas, y proceder a la realización de cortes, orificios o a la distribución del adhesivo; en caso de mecanizado, la placa se debe colocar con el frente hacia arriba, mientras que, para aplicar el adhesivo, debe colocarse con el frente mirando hacia abajo o hacia el interior del caballete con ruedas.
- colocarlas en el suelo; en tal caso, se recomienda proteger los bordes.

SLABS 6,5MM

ОБРАБОТКА УПАКОВКИ И ПЛИТ

ЯЩИКИ И ПОДСТАВКИ

Для хранения и перевозки плит в условиях наивысшей безопасности существуют специальные типы упаковки:

- ящики (из дерева); плиты горизонтально укладываются в специальные деревянные ящики, изготовленные в размер
- подставки (из дерева); плиты устанавливаются в вертикальном положении на специальные деревянные конструкции в форме подставки, которые изготовлены на заказ и специально разработаны для перевозки в контейнерах.

ПЕРЕМЕЩЕНИЕ ЯЩИКОВ

Рекомендуется перемещать ящики по одному, а также предварительно проверить, что грузоподъемность погрузчика соответствует перевозимому весу.

Для хранения ящиков и только в том случае, если они одинаковы, их можно штабелировать по 8 штук максимум.

Перемещение ящика захватом с длинной стороны

Это - наиболее рекомендованный вариант перемещения. Для его выполнения рекомендуется использовать вилы с минимальной длиной 1,2 м, вводя их в специальные проемы в ящике, которые выполнены на длинной стороне для обеспечения наибольшей устойчивости.

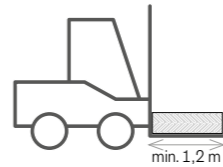

Перемещение ящика с короткой стороны Эта операция должна выполняться

лишь только для погрузки и разгрузки контейнеров, для чего рекомендуется использование вилок с минимальной длиной 2,1 м.

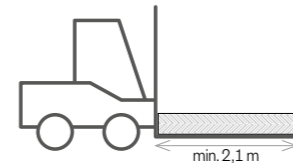

ПЕРЕМЕЩЕНИЕ ПОДСТАВОК

Рекомендуется перемещать подставки по одной, а также предварительно проверить, что грузоподъемность погрузчика соответствует перевозимому весу.

Перемещение подставки с захватом с длинной стороны

Это - наиболее рекомендованный вариант перемещения. Для его выполнения рекомендуется использовать вилы с минимальной длиной 1,2 м, вводя их в специальные проемы в подставке, которые выполнены на длинной стороне для обеспечения наибольшей устойчивости.

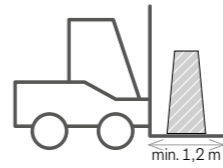

Перемещение подставки с захватом с короткой стороны

Эта операция должна выполняться лишь только для погрузки и разгрузки контейнеров, для чего рекомендуется использование вилок с минимальной длиной 2,1 м.

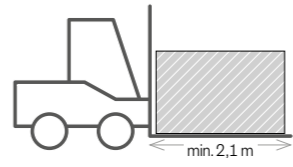

EMILCERAMICA

ИНСТРУМЕНТ

Для выполнения всех операций по перемещению плит рекомендуется использовать средства, специально разработанные для керамических изделий большого формата.

Штанги с присосками - Этот инструмент состоит из двух пар соединенных друг с другом алюминиевых профилей, которые способны перемещаться друг относительно друга, оборудованных рядом качающихся присосок с вакуумметром, которые отлично работают даже на фактурных поверхностях. Установив это устройство на плиту, повышается ее жесткость, что позволяет перемещать ее в условиях наивысшей безопасности.

Тележка - Алюминиевая конструкция, оборудованная колесами и крюками с регулируемой высотой, предназначенными для удержания устройств перемещения. Позволяет проще и надежнее перемещать плиты и облегчает нанесение клея. Кроме того, ее использование настоятельно рекомендуется для перевозки плит с обработкой (напр., с отверстиями, Г- и С-образной резкой и т.д.).

ПЕРЕМЕЩЕНИЕ

Для перемещения и последующего извлечения плит из упаковки можно использовать комплект для подъема плит, состоящий из алюминиевых рам с присосками. Плиты следует переносить по одной, минимум вдвоем (количество человек меняется в зависимости от размеров и толщины переносимой плиты). Подъемные присоски должны устанавливаться на плиту после предварительной очистки точки сопряжения, чтобы обеспечить равновесие во время перемещения. Плиты следует поднимать чрезвычайно осторожно, стараясь избегать раскачиваний или вибрации, обращая особое внимание на кромки.

После того, как плиты были извлечены из упаковки, их можно:

- Положить на горизонтальный рабочий стол или же на тележку для выполнения резки, сверления или нанесения клея. В случае выполнения обработки плита должна быть уложена лицевой стороной вверх, в случае нанесения клея плита должна быть уложена лицевой стороной вниз или же внутрь тележки.
- Положить на пол. В этом случае рекомендуется защитить кромки.

EMILCERAMICA

CONSIGLI DI MANUTENZIONE

ISTRUZIONI PER LA PRIMA PULIZIA DOPO LA POSA

L'accuratezza e la tempestività della pulizia iniziale è di basilare importanza; è necessaria su tutte le tipologie di pavimentazione ceramica al fine di garantire un'agevole pulizia quotidiana. Nel caso in cui venisse trascurata e non effettuata potrebbero insorgere alonature che impedirebbero di mantenere pulito il pavimento nonostante una buona manutenzione quotidiana. È necessario lavare accuratamente il pavimento per rimuovere i residui cementizi e di stuccatura.

Per stucchi di tipo cementizio occorre attendere non più di 48 ore prima di effettuare la pulizia, per stucchi additivi con lattice o epossidici occorre effettuare molto rapidamente la pulizia in quanto l'indurimento dei componenti ne renderebbe molto difficoltosa la rimozione.

I prodotti indicati per questo tipo di pulizia devono essere di natura acida (vedi tabella esemplificativa).

Per realizzare la pulizia seguire i passaggi elencati sotto:

- Stesura del prodotto acido diluito in soluzione variabile da 10 a 20% sulla superficie.

- Attendere 7/10 minuti

- Effettuare la pulizia esercitando una decisa azione meccanica; utilizzare strumenti di pulizia manuale o adeguate macchine lavapavimenti (si consiglia l'utilizzo di macchine lava-pavimenti dotate di spazzole bianche in feltro; evitare l'utilizzo di spazzole nere a residuo carbonioso). L'operazione di lavaggio deve essere il più possibile omogenea.

- Neutralizzare la soluzione acida con abbondante risciacquo, possibilmente con acqua calda. Il risciacquo deve essere effettuato più volte fino alla completa rimozione di tutto il residuo acido.

Per agevolare l'esecuzione della pulizia acida iniziale si consiglia di utilizzare un apposito dispositivo aspira-liquidi allo scopo di evitare l'essiccazione della soluzione acqua-acido, la patina essiccata della soluzione renderebbe vana l'operazione di pulizia.

Per prodotti strutturati, con rilievi pronunciati o finiture antiscivolo il lavaggio acido deve essere effettuato con la massima rapidità dopo la posa. Prima del lavaggio acido, durante la posa, si consiglia di rimuovere gli eccessi di stuccatura con spugna e acqua.

Si consiglia di provare preventivamente il lavaggio su una piastrella non posata, in particolar modo in caso di prodotti lappati o levigati.

PROTEZIONE DEL PAVIMENTO FINO A TERMINE DEI LAVORI

Dopo la posa e la successiva pulizia, raccomandiamo di prestare particolare attenzione alla protezione del pavimento, per evitare di danneggiarlo durante i lavori di finitura del cantiere. Si consiglia di ricoprire l'intera superficie con cartoni di spessore adeguato.

ISTRUZIONI PER LA PULIZIA ORDINARIA

I prodotti Emilceramica sono di facile manutenzione, a conferma del nostro impegno verso l'ambiente. Le modalità e la frequenza di pulizia devono comunque essere adeguate alla destinazione d'uso.

Per una efficace manutenzione si consiglia:

1. Di non lasciare lo sporco troppo a lungo sul pavimento.

2. Di lavare regolarmente il pavimento utilizzando detergenti neutri o sgrassatori diluiti in acqua calda seguendo le indicazioni delle confezioni.

3. Risciacquare con acqua pulita.

ISTRUZIONI PER LA PULIZIA STRAORDINARIA

La manutenzione straordinaria si rende necessaria nel caso in cui eventi accidentali causino macchie e/o sporco dovuto a particolari sostanze. In questi casi occorre intervenire con detergenti professionali a base alcalina specifici per il tipo di sporco da rimuovere (vedi tabella esemplificativa)

Per una efficace pulizia straordinaria si consiglia di:

1. Lavaggio con acqua per rimozione dello sporco superficiale.

2. Stesura del prodotto alcalino diluito in soluzione media del 3% sulla superficie. Per situazioni di difficile rimozione delle patine o di particolari agenti macchianti è possibile aumentare progressivamente la concentrazione del detergente.

3. Attesa di 7/10 minuti. Per agenti macchianti di difficile rimozione è possibile aumentare l'effetto abrasivo utilizzando un sapone secco in polvere da spargere sul detergente al termine del periodo di attesa.

MANUTENZIONE ED UTILIZZO DI SUPERFICI LAPPATE

Sabbia, pietrisco ed altri elementi di elevata durezza possono produrre graffiature su ogni tipo di pavimentazione, quali pietre naturale, legno, vinile e gres porcellanato.

Si consiglia pertanto di:

- rimuovere l'imballo contestualmente all'inizio della posa

- non impilare e/o movimentare il materiale privo di imballo

- non calpestare le superfici durante l'installazione

- pulire perfettamente il pavimento da residui di cantiere

- effettuare accurata copertura della superficie fino a fine lavori

EMILCERAMICA

ADVICE FOR MAINTENANCE

INSTRUCTIONS FOR INITIAL CLEANING AFTER INSTALLATION

Quick, thorough initial cleaning is of fundamental importance and is necessary on all types of ceramic tile to allow easy subsequent daily cleaning.

In the event of the failure to carry out this procedure properly, smears may be left which make it impossible to keep the floor clean in spite of thorough routine cleaning.

The floor must be washed thoroughly to remove cement and grout residues.

For cement-based grouts, clean within no more than 48 hours. For grouts containing latex or epoxy resins, cleaning must be carried out very quickly, since the components are very difficult to remove once set.

The recommended products for this type of cleaning are acid-based (see table of examples).

To clean, proceed as follows:

- Apply the acid product diluted in a 10-20% solution to the surface.

- Wait 7/10 minutes.

- Clean with a vigorous scrubbing action, with suitable equipment by hand, or appropriate floor cleaning appliances (floor cleaners fitted with white felt brushes are recommended; do not use black brushes which leave a carbon residue). Take care to clean the whole floor as evenly as possible.

- Neutralise the acid solution by washing with plenty of water, hot if possible. Keep rinsing until all acid residue has been removed.

To aid in the initial acid cleaning operation, use of a special vacuum drier is recommended to prevent the water-acid solution from drying; if the solution dries to form a coating over the surface, the cleaning procedure will have failed.

For structured products, with noticeable relief patterns or anti-slip surfaces, acid washing must be carried out as soon as possible after installation. Before washing with acid, excess grout should be removed with a sponge and water during the installation procedure itself.

The effect of the washing operation should be tested on a spare tile before proceeding, especially in the case of honed or polished products.

PROTECTING THE FLOOR DURING THE REMAINDER OF THE CONSTRUCTION WORK

After laying and cleaning, it is essential to take special care to protect the floor to prevent damage during finishing works on the site. The entire surface should be covered with cardboard of suitably thickness.

ROUTINE CLEANING INSTRUCTIONS

Emilceramica products are easy to care for, confirming our commitment to the environment. However, cleaning procedures and frequency will always depend on the context in which the tiles are used.

For effective care, we recommend the following:

1. Do not leave dirt on the floor for too long.

2. Wash the floor regularly with neutral or degreasing detergents diluted in hot water, following the instructions on the pack.

3. Rinse with clean water.

EXTRAORDINARY CLEANING INSTRUCTIONS

Extraordinary cleaning procedures are needed if the floor becomes stained or dirty with specific substances due to accidents. In this case, professional, alkaline detergents, specifically developed for the type of dirt to be removed (see table of examples), are required.

For effective extraordinary cleaning, we recommend the following:

1. Wash with water to remove superficial dirt.

2. Apply the alkaline product diluted in a solution of about 3% to the surface. The detergent concentration can be gradually increased to deal with difficult cases where coatings have to be removed, or unusually tough stains.

3. Wait 7/10 minutes. For stubborn stains, the abrasive effect can be increased by using a dry powder soap, sprinkling it over the detergent at the end of the waiting time.

CARE AND USE OF SEMI-POLISHED SURFACES

Sand, gravel and other very hard substances may scratch any type of flooring, including natural stones, parquet, vinyl and porcelain stoneware.

You are therefore advised:

- to remove packaging only just before installation

- not to stack and/or handle material without its packaging

- not to tread on surfaces during installation

- to remove all worksite residues from the floor with great care

- to cover surfaces carefully until all work on site is complete

EMILCERAMICA

CONSEIL D' ENTRETIEN

RECOMMANDATIONS

INSTRUCTIONS POUR LE PREMIER NETTOYAGE APRÈS LA POSE

Il est très important que le nettoyage initial soit effectué avec le plus grand soin et tout de suite après la pose, sur tous les types de carrelage céramique, afin de garantir un nettoyage quotidien facile. Si le nettoyage n'est pas bien fait, des auréoles pourraient se former et empêcher que le carrelage soit propre malgré un bon entretien quotidien. Laver soigneusement le carrelage pour enlever tous les résidus de ciment et de produit de jointoiement. Pour les ciments-joints, attendre moins de 48 heures avant de nettoyer, pour les adjuvants avec latex ou les joints époxy, effectuer le nettoyage très rapidement car si les composants durcissent leur enlèvement devient extrêmement difficile.

Les produits indiqués pour ce type de nettoyage doivent être de nature acide (voir tableau avec exemples).

Pour le nettoyage, procéder comme suit:

- Étaler sur la surface le produit acide dilué dans une solution variable de 10 à 20%.

- Attendre 7/10 minutes

- Effectuer le nettoyage en exerçant une action mécanique ferme ; utiliser des instruments de nettoyage manuel ou des nettoyeurs appropriés (il est conseillé d'utiliser des nettoyeurs équipés de brosses blanches en feutre; éviter les brosses noires à résidu carboné). L'opération de lavage doit être le plus possible homogène.

- Neutraliser la solution acide avec un rinçage abondant, si possible à l'eau chaude. Le rinçage doit être fait plusieurs fois jusqu'à ce qu'il n'y ait plus du tout de résidu acide. Pour faciliter le nettoyage acide initial, utiliser un dispositif approprié d'aspiration des liquides afin d'éviter le séchage de la solution eau-acide; la patine séchée de la solution rendrait inutile l'opération de nettoyage. Pour des produits structurés, avec des reliefs prononcés ou des finitions anti-dérapantes, le lavage acide doit être effectué le plus tôt possible après la pose. Avant le lavage acide, pendant la pose, enlever les surplus de produit de jointoiement avec une éponge et de l'eau. Il est conseillé de faire un essai avant le lavage sur un carreau non posé surtout dans le cas de produits rodés ou polis.

RECOMMANDATIONS

PROTECTION DU CARRELAGE JUSQU'À LA FIN DES TRAVAUX

Après la pose et le nettoyage, faire très attention à la protection du carrelage pour éviter de l'endommager pendant les travaux de finition du chantier. Il est conseillé de couvrir toute la surface avec des cartons d'une épaisseur appropriée.

RECOMMANDATIONS

INSTRUCTIONS POUR LE NETTOYAGE COURANT

Les produits Emilceramica sont d'un entretien facile ce qui confirme notre engagement pour la protection de l'environnement. Les modalités et la fréquence de nettoyage doivent être adaptées à la destination d'usage.

Pour un entretien efficace, il est conseillé:

- De ne pas laisser le carrelage sale trop longtemps.
- De laver régulièrement le sol en utilisant des détergents neutres ou des produits de dégraissage dilués dans de l'eau chaude en suivant les indications des conditionnements.
- De rincer à l'eau propre.

RECOMMANDATIONS

INSTRUCTIONS POUR LE NETTOYAGE EXTRAORDINAIRE

L'entretien extraordinaire s'avère nécessaire si des actions accidentelles causent des taches et/ou de la saleté due à des substances particulières. Dans ces cas, intervenir avec des détergents professionnels à base alcaline, spécifiques pour le type de saleté à nettoyer (voir tableau avec exemples). Pour un entretien extraordinaire efficace, il est conseillé:

- De laver avec de l'eau pour enlever la saleté superficielle.
- D'étendre le produit alcalin sur la surface dilué en solution moyenne de 3%. Si la patine ou les agents tachants particuliers sont difficiles à nettoyer, augmenter progressivement la concentration du détergent.
- Attendre 7/10 minutes. Pour des agents tachants difficiles à enlever, augmenter l'effet abrasif en utilisant un savon sec en poudre à répandre sur le détergent à la fin de la période d'attente.

RECOMMANDATIONS

ENTRETIEN ET UTILISATION DES SURFACES RODÉES

Le sable, la pierraille et les autres éléments présentant une dureté élevée risquent de rayer tous les revêtements de sol, comme les pierres naturelles, le bois, le vinyle et le grès cérame.

Il est recommandé de :

- retirer le matériel de son emballage uniquement au moment de la pose

- ne pas empiler ni manutentionner le matériel sans emballage

- ne pas marcher sur les surfaces pendant l'installation

- nettoyer parfaitement le revêtement de sol pour éliminer tous les résidus de chantier

- bien couvrir la surface jusqu'à la fin des travaux

RECOMMANDATIONS

PFLEGEHINWEISE

RECOMMANDATIONS

ANWEISUNGEN FÜR DIE ERSTREINIGUNG NACH DER VERLEGUNG

Eine gründliche und unverzügliche Erstreinigung ist von grundlegender Bedeutung. Sie ist für alle keramischen Bodenbeläge erforderlich, um eine einfache Unterhaltsreinigung zu gewährleisten.

Wird die Erstreinigung fahrlässig ausgeführt oder unterlassen, könnten Zementschleier entstehen, die trotz gründlicher Unterhaltsreinigung ein unsauberes Erscheinungsbild verursachen.

Die Bodenfläche ist gründlich mit Wasser zu reinigen, um Zement- und Mörtelrückstände zu entfernen.

Bei zementären Fugenmörteln dürfen bis zur Erstreinigung nicht mehr als 48 Stunden verstreichen, bei Fugenmörteln mit Latex- oder Epoxydharzvergütung ist die Reinigung sehr zügig auszuführen, weil die Komponenten andernfalls aushärten und die Entfernung ernsthaft erschweren.

Für die Erstreinigung sind saure Reiniger zu verwenden (siehe Übersichtstabelle).

Vorgehensweise für die Reinigung:

- Saures Reinigungsmittel in einer 10- bis 20-prozentigen Reinigungslösung auf die Oberfläche aufbringen.

- 7/10 Minuten abwarten.

- Mit energischen Wischbewegungen reinigen. Manuelle Reinigungsgeräte oder geeignete Reinigungsmaschinen verwenden (es werden Reinigungsmaschinen mit weißen Filzbürsten empfohlen, schwarze Bürsten mit Kohlerückständen sind nicht geeignet). Die Nassreinigung soll möglichst gleichmäßig erfolgen.

- Die saure Reinigungslösung durch eine reichliche Nachspülung mit Wasser, das möglichst warm sein sollte, neutralisieren. Es ist mehrmals mit Wasser nachzuspülen, bis alle Säurerückstände vollständig entfernt sind.

Für eine einfache Erstreinigung mit saurem Reiniger wird die Verwendung eines Flüssigkeitssaugers empfohlen, um die Antrocknung der Reinigungslösung zu vermeiden.

Der angetrocknete Lösungsbelag würde die Reinigungswirkung aufheben.

Bei Erzeugnissen mit rutschhemmender, Struktur- oder Reliefoberfläche ist die Säurereinigung nach der Verlegung mit größter Zügigkeit auszuführen. Vor der Säurereinigung wird während der Verlegung empfohlen, überschüssigen Fugenmörtel mit Wasser und Schwamm zu entfernen.

Die Reinigung sollte zuvor probeweise auf einer unverlegten Fliese ausgeführt werden, das gilt insbesondere für geläppte und polierte Fliesen.

RECOMMANDATIONS

SCHUTZ DES BODENBELAGS BIS ZUR BEENDIGUNG DER ARBEITEN

Nach der Verlegung und der anschließenden Reinigung empfehlen wir, sorgfältig auf den Schutz des Bodens vor Beschädigungen während der Abschlussarbeiten zu achten. Es wird empfohlen, die gesamte Fläche mit Karton geeigneter Stärke abzudecken.

RECOMMANDATIONS

ANWEISUNGEN FÜR DIE UNTERHALTSREINIGUNG

Emilceramica achtet auf den Umweltschutz. Daher sind die Erzeugnisse des Keramikherstellers reinigungsfreundlich. Die Reinigungsverfahren und -häufigkeit müssen jedoch auf die Zweckbestimmung abgestimmt sein.

Empfehlungen für eine wirksame Unterhaltsreinigung:

- Schmutz nicht zu lange auf dem Boden lassen.
- Den Boden regelmäßig mit neutralen oder fettlösenden Reinigern in einer Reinigungslösung mit warmem Wasser gemäß den Verpackungsanweisungen reinigen.
- Mit sauberem Wasser nachspülen.

RECOMMANDATIONS

ANWEISUNGEN FÜR DIE SONDERREINIGUNG

Die Sonderreinigung ist erforderlich, wenn unerwünschte Ereignisse Flecken- und/oder Verunreinigungen infolge bestimmter Substanzen verursachen. In diesen Fällen sind professionelle alkalische Spezialreiniger in Abhängigkeit von dem zu entfernenden Schmutz zu verwenden (siehe Beispieltabelle).

Empfehlungen für eine wirksame Sonderreinigung:

- Den Oberflächenschmutz durch Wischen mit Wasser entfernen.
- Alkalisches Reinigungsmittel in einer durchschnittlich 3-prozentigen Reinigungslösung auf die Oberfläche aufbringen. Bei hartnäckigen Streifen oder besonderen Fleckenbildnern kann die Konzentration des Reinigers schrittweise erhöht werden.
- 7/10 Minuten abwarten. Bei hartnäckigen Fleckenbildnern kann die Abriebwirkung durch die Verwendung einer pulverförmigen Trockenseife erhöht werden, die nach der Wartezeit auf den Reiniger aufgestreut wird.

RECOMMANDATIONS

REINIGUNG, PFLEGE UND NUTZUNG GELÄPPTER OBERFLÄCHEN

Sand, Splitt und sonstige Elemente oder Teile mit erheblicher Härte können zu Kratzern auf jedem Bodenbelagstyp, z.B. aus Naturstein, Holz, Vinyl, Feinsteinzeug usw., führen.

Es empfiehlt sich deshalb, zum Schutz der Bodenbeläge folgende Maßnahmen zu ergreifen:

- die Verpackungen unmittelbar nach Beginn der Verlegearbeiten entfernen

- unverpacktes Material nicht stapeln und/oder handhaben bzw. bewegen

- während der Installation nicht auf die Oberflächen treten

- die Bodenbeläge einwandfrei reinigen und dabei sämtliche Baustellenreste vollständig entfernen

- die Oberfläche bis zum Abschluss der Arbeiten mit passenden Abdeckungen entsprechend schützen

EMILCERAMICA

CONSEJOS DE MANTENIMIENTO

EMILCERAMICA

INSTRUCCIONES PARA EFECTUAR LA PRIMERA LIMPIEZA TRAS LA COLOCACIÓN

La precisión y la rapidez de la limpieza inicial es de fundamental importancia; dicha limpieza es necesaria en todos los tipos de pavimentos cerámicos a fin de garantizar la facilidad de la limpieza diaria.Si, por no dársele la importancia necesaria, no se realiza esta limpieza, podrían crearse halos que impedirán mantener limpio el pavimento aunque se realice un mantenimiento diario correcto. Es necesario lavar a fondo el pavimento para retirar todos los restos de cemento y rejuntado. Para morteros cementosos, no se debe esperar más de 48 horas para realizar la limpieza; para morteros aditivados con látex o epoxidicos, la limpieza se debe realizar muy rápidamente ya que, de lo contrario, el endurecimiento de sus componentes hará que sea muy difícil eliminar los restos. Los productos indicados para este tipo de limpieza deben ser de tipo ácido (consultar la tabla).

Para realizar la limpieza, seguir los pasos que aparecen a continuación.

- Aplicar el producto ácido diluido en solución variable entre 10 y 20 % sobre la superficie.

- Esperar entre 7 y 10 minutos.

- Realizar la limpieza ejerciendo una acción mecánica resuelta, utilizando instrumentos de limpieza manual o máquinas lava-pavimentos adecuadas (se aconseja usar máquinas lava-pavimentos provistas de escobillas blancas de fieltro; evítese el uso de escobillas negras que dejan residuos carbonosos). La operación de lavado debe ser lo más homogénea posible.

- Neutralizar la solución ácida enjuagando a fondo, posiblemente con agua caliente. El enjuague se debe efectuar varias veces, hasta que se elimine completamente los residuos ácidos. Para facilitar la limpieza ácida inicial, es aconsejable utilizar un dispositivo aspirador de líquidos a fin de evitar que se seque la solución de agua y ácido, ya que la pátina seca de la solución haría inútil la operación de limpieza. Para los productos estructurados, con relieves pronunciados o acabados antideslizantes, el lavado ácido se debe realizar lo más pronto posible tras su colocación. Antes del lavado ácido, durante la colocación, es aconsejable eliminar los restos de producto de rejuntado con una esponja mojada en agua. Es aconsejable hacer una prueba de lavado en una baldosa sobrante no colocada, especialmente cuando se trata de productos lapeados o pulidos.

EMILCERAMICA

PROTECCIÓN DEL PAVIMENTO HASTA LA CONCLUSIÓN DE LA OBRA

Tras la colocación y la limpieza, recomendamos tener especial cuidado para proteger el pavimento de forma que no se dañe durante los trabajos de finalización de la obra. Es recomendable cubrir toda la superficie con cartones que tengan un grosor adecuado.

EMILCERAMICA

INSTRUCCIONES PARA EFECTUAR LA LIMPIEZA ORDINARIA

Los productos de Emilceramica se caracterizan por su facilidad de mantenimiento, lo que confirma nuestro compromiso con el medio ambiente. No obstante, la moda-

lidad y la frecuencia de limpieza se deben adaptar al uso previsto.

Para realizar un mantenimiento eficaz, es aconsejable:

- No dejar el pavimento sucio durante demasiado tiempo.
- Lavar con regularidad el pavimento utilizando detergentes neutros o desengrasantes diluidos en agua caliente, siguiendo las instrucciones del fabricante.
- Enjuagar con agua limpia.

EMILCERAMICA

INSTRUCCIONES PARA EFECTUAR LA LIMPIEZA EXTRAORDINARIA

Se debe realizar el mantenimiento extraordinario cuando por accidente se produzcan manchas y/o suciedad causadas por sustancias especiales. En estos casos, es necesario utilizar detergentes profesionales de base alcalina específicos para el tipo de suciedad que se debe eliminar (consultar la tabla). Para realizar una limpieza extraordinaria eficaz, es aconsejable:

- Lavar el pavimento con agua para eliminar la suciedad superficial.
- Aplicar el producto alcalino diluido en solución media del 3% sobre la superficie. Para los casos en que sea difícil eliminar las pátinas o si las manchas han sido causadas por algún producto especial, se puede aumentar progresivamente la concentración del detergente.
- Esperar entre 7 y 10 minutos. Para las manchas difíciles de eliminar, se puede aumentar el efecto abrasivo utilizando jabón en polvo seco que se esparce sobre el detergente tras finalizar el periodo de espera.

EMILCERAMICA

La arena, la grava y demás elementos de elevada dureza pueden ocasionar arañazos en toda clase de pavimento, de piedra natural, de madera, vinilo o gres porcelánico.

Por ello se aconseja:

- no quitar el embalaje hasta que se vaya a proceder a la colocación

- no apilar ni desplazar el material si no está embalado

- no pisar las superficies durante la instalación

- limpiar perfectamente el pavimento de modo que no queden residuos de las obras

- mantener bien cubierta la superficie hasta la conclusión de los trabajos

EMILCERAMICA

ИНСТРУКЦИИ ПО ЭКСПЛУАТАЦИИ

EMILCERAMICA

ИНСТРУКЦИИ ПО ПЕРВОЙ ЧИСТКЕ ПОСЛЕ УКЛАДКИ

Тщательность и своевременность начальной чистки имеет чрезвычайную важность. Она необходима для всех типов керамического пола для облегчения ежедневной чистки.

В случае, если чисткой пренебрегают или ее не выполняют, могут образоваться разводы, которые не позволят содержать пол в чистоте, несмотря на хороший ежедневный уход.

Необходимо тщательно промыть пол, чтобы удалить остатки цемента и затирки.

Для затирок цементного типа следует подождать не более 48 часов перед выполнением чистки, для затирок с добавками латекса или эпоксидными чистку следует выполнять очень быстро, так как отвердевание компонентов может существенно затруднить удаление затирки. Продукты, рекомендованные для чистки данного типа, должны быть кислотными (см. пояснительную таблицу).

Для выполнения чистки выполняйте приведенные ниже действия:

- Нанесение кислотного продукта в растворе от 10 до 20% на поверхности.

- Подождите 7/10 минут.

- Выполняйте чистку, оказывая решительное механическое воздействие. Используйте средства ручной чистки или же пригодные полотеры (рекомендуется использовать полотеры с белыми фетровыми щетками, не допускайте использование черных щеток, содержащих углерод). Чистка должна выполняться как можно более равномерно.

- Нейтрализуйте кислотный раствор обильной промывкой, желательнo горячей водой. Промывку следует выполнять несколько раз, вплоть до полного удаления остатков кислоты.

Для облегчения выполнения начальной кислотной чистки рекомендуется использовать специальное устройство для сбора жидкостей, чтобы не допустить высушивания водного раствора кислоты: высохшая патина раствора сделает операцию чистки бессмысленной.

Для структурированной продукции с выраженным рельефом или же несколькозой отделкой промывка кислотой должна выполняться как можно скорее после укладки. Перед промывкой кислотой, во время укладки, рекомендуется удалить излишки затирки губкой и водой.

Рекомендуется предварительно попробовать промывку на неуложенной плитке, в особенности, если это плитка с притертой или шлифованной поверхностью.

EMILCERAMICA

ЗАЩИТА ПОЛА ДО КОНЦА РАБОТ

После укладки и последующей очистки рекомендуем обратить особенное внимание на защиту пола, чтобы не допустить его повреждение во время отделочных работ при строительстве. Рекомендуется накрыть всю поверхность картоном необходимой толщины.

EMILCERAMICA

ИНСТРУКЦИИ ПО ОБЫЧНОЙ ЧИСТКЕ

Продукция Emilceramica проста в обслуживании, что подтверждает нашу заботу об окружающей среде. Способы и периодичность очистки должны в любом случае соответствовать назначению.

Для эффективного ухода рекомендуем:

- Не оставлять грязь слишком надолго на полу.
- Регулярно промывать пол, используя нейтральные или обезжиривающие средства, разбавленные в теплой воде, выполняя указания, приведенные на упаковках.
- Промывать чистой водой.

EMILCERAMICA

ИНСТРУКЦИИ ПО ЭКСТРЕННОЙ ЧИСТКЕ

Экстренная чистка становится необходимой в тех случаях, когда случайные события приводят к образованию пятен и/или грязи, вызванных особенными веществами. В этих случаях следует использовать профессиональные моющие средства на щелочной основе, специально предназначенные для типа удаляемого загрязнения (см. пояснительную таблицу).

Для эффективной экстренной чистки рекомендуется:

- Промывка водой для удаления грязи с поверхности.
- Нанесение 3% раствора щелочного продукта на поверхность. В ситуациях с затрудненным удалением патиn или особыхных пятнообразующих агентов можно постепенно увеличивать концентрацию моющего средства.
- Выдержка 7-10 минут. Для трудновыводимых пятнообразующих веществ можно повысить абразивный эффект, используя сухое порошковое моющее средство, наносимое на жидкое моющее средство по истечении времени выдержки.

EMILCERAMICA

УХОД И ИСПОЛЬЗОВАНИЕ ШЛИФОВАННЫХ ПОВЕРХНОСТЕЙ

Песок, мелкие камешки и другие материалы повышенной твердости могут образовывать царапины на полах любого типа, изготовленных из таких материалов, как природный камень, дерево, винил или керамогранит.

Поэтому, мы рекомендуем:

- распаковывать изделия, когда начинается их укладка

- не класть друг на друга и/или не перемещать неупакованные материалы

- не ходить по поверхностям во время укладки

- тщательно очищать пол от строительных отходов

- тщательно накрыть поверхность до окончания работ

Tipo di sporco - Type of mark Type de salissure - Schmutzart Tipo de suciedad - Тип загрязнения	Detergente consigliato - Detergent recommended Detergent conseille - Empfohlenes Reinigungsmittel Detergente aconsejado - Рекомендуемое моющее средство					
	Solvente (acetone o acquaragia o trielina) Solvent Solvant Lösemittel Solvente Растворитель (ацетон или скипидар или разбавитель)		Detergente a base acida Acid based detergent Detergent a base acide Reinigungsmittel auf säurebasis Detergente de base ácida Моющее средство на кислотной основе		Detergente a base alcalina Alkaline based detergent Detergent a base alcaline Reinigungsmittel auf alkalibasis Detergente de base alcalina Моющее средство на щелочной основе	
	FILA	FABER	FILA	FABER	FILA	FABER
Birra, vino - Beer, wine - Bier,wein - Biere, vin - Cerveza,vino - Пиво, вино					PS-87 PRO	STAIN REMOVER POWDER
Caffè - Coffee - Cafe - Kaffee - Cafe - Кофе					PS-87 PRO	STAIN REMOVER POWDER
Catrame - Tar - Goudron - Teer - Alquitran - Гудрон	SOLV	SOLVENT STRIPPER				
Cauciù - Rubber - Caoutchouc - Kautschuk - Caucho - Каучук	SOLV	SOLVENT STRIPPER				
Cemento - Cement - Ciment - Zement - Cemento - Цемент			DETERDEK PRO	CEMENT REMOVER		
Cera di candela candle wax - Cire de bougie - Kerzenwachs - Cera de vela - Свечной воск	SOLV	SOLVENT STRIPPER				
Coca cola - Coke - Coca-cola - Соса-cola - Соса-cola - Кока-кола					PS-87 PRO	STAIN REMOVER POWDER
Efflorescenze calcaree - Calcareous efflorescences - Efflorescences calcaires - Kalk ausblühungen Eflorescencias calcareas - Известковые проявления			DETERDEK PRO	CEMENT REMOVER		
Gesso - Chalk - Platre - Gips - Yeso - Гипс			DETERDEK PRO	CEMENT REMOVER		
Grassi animali - Animal fats - Graisses animales - Tierische fette - Grasas animales - Животный жир					PS-87 PRO	DEEP DEGREASER
Grassi vegetali - Vegetable fats - Grasas vegetales - Pflanzliche fette graisses vegetales - Растительный жир					PS-87 PRO	DEEP DEGREASER
Gelato icecream - Glace - Eis - Helado - Мороженое					PS-87 PRO	DEEP DEGREASER
Inchiostri - Inks - Encres - Tinte - Tintas - Чернила					PS-87 PRO - SR 95	DEEP DEGREASER
Lampostil - Felt pens - Feutre - Filzstift - Rotuladores - Фломастер					PS-87 PRO	DEEP DEGREASER
Ketchup - Кетчуп					PS-87 PRO	DEEP DEGREASER
Maionese - Mayonnaise - Mayonnaise - Majonase - Mayonesa - Майонез					PS-87 PRO	DEEP DEGREASER
Marmellata - Jam - Confiture - Marmelade - Mermelada - Варенье					PS-87 PRO	DEEP DEGREASER
Olii meccanici / siliconati - Mechanical / Silicone oils - Huiles mecaniques / siliconees - Maschinen- Silikonöl Aceites mecanicos/ con silicona - Механические/ Силиконовые масла	SOLV	OIL & GREASE REMOVER			PS-87 PRO	DEEP DEGREASER
Olio di lino - Linseed oil - Huile de lin - Leinoel - Aceite de lino - Льняное масло	SOLV	OIL & GREASE REMOVER				
Pneumatico - Tyres - Pneumatique - Reifen - Neumatico - Следы шин					PS-87 PRO	DEEP DEGREASER
Residui metallici - Metal residues - Residus de metaux - Metallrueckstaende - Residuos metalicos - Следы металлов			DETERDEK PRO	TILE CLEANER		
Resine o smalti - Resins or enamels - Resines ou emaux - Harze oder lacke - Resinas o esmaltes - Смолы или эмали			NO PAINT STAR	EPOXY CLEANER		
Rossetto - Lipstick - Rouge a levres - Lippenstift - Pintalabios - Помада					PS-87 PRO	DEEP DEGREASER
Ruggine - Rust - Rouille - Rost - Herrumbre - Ржавчина			DETERDEK PRO	MARGEL PLUS / OXIDANT		
Stucco - Plaster - Mastic - Fugenmasse - Estuco - Затирка			DETERDEK PRO	TILE CLEANER		
Tempere murarie - Water based wall paint - Temperas murales - Maueranstriche detrepes - Краски для стен			DETERDEK PRO	TILE CLEANER		
Silicone - Silicone - Silicone - Silikon - Silicona - Силикон	SOLV	EPOXY CLEANER				
Chewing-gum - Chewing-gum - Chewing-gum - Kaugummi - Goma de mascar - Жевательная резинка					PS-87 PRO	DEEP DEGREASER

ATTENZIONE! Usare molta prudenza utilizzando acidi o altri prodotti chimici, attenersi scrupolosamente alle istruzioni indicate dai produttori sulle confezioni. Si consiglia di cominciare sempre ad utilizzare i prodotti diluiti in acqua 1:5 e di aumentare gradualmente la concentrazione se non si ottiene l'eliminazione della macchia.

NOTE! Be very careful when using acids or other chemical products and strictly follow the manufacturer's instructions on the product. It is always advisable to begin using the products diluted 1:5 in water and gradually increase the concentration if the mark or stain is not eliminated.

ATTENTION! Soyez très prudents lorsque vous employez des acides ou autres produits chimiques; suivez scrupuleusement les modes d'emploi des fabricants sur les emballages. Il est conseillé de commencer toujours à utiliser les produits dilués dans de l'eau (dilution 1:5) en augmentant graduellement la concentration si l'on n'obtient pas l'élimination de la tache.

ACHTUNG! Bei der Verwendung von Säuren oder anderen chemischen Produkten sollte man sich strikt an die Anweisungen des Herstellers auf den Verpackungen halten. Es wird empfohlen, die Produkte immer erst verdünnt (im Verhältnis 1:5 mit Wasser) zu verwenden und dann schrittweise die Konzentration zu erhöhen, wenn der Fleck sich nicht entfernen lässt.

ATENCIÓN! Proceder con mucha prudencia al utilizar ácidos u otros productos químicos y respetar rigurosamente las instrucciones indicadas por los productores en los envases. Se aconseja comenzar siempre utilizando los productos diluidos en agua 1:5 y aumentar gradualmente la concentración si no se obtiene la eliminación de la mancha.

ВНИМАНИЕ! Будьте чрезвычайно осторожными, используя кислоты или другие химические продукты, тщательно придерживайтесь инструкций, указанных производителями на упаковках. Рекомендуется всегда использовать продукты, разбавленные в воде в пропорции 1:5, и постепенно повышать концентрацию, если пятно не выводится.

EMILCERAMICA

DESTINAZIONI D’ USO

Intended uses | Domaines d’application | Zweckbestimmung | Usos previstos | Назначение

REQUISITI PER L’USO

I prodotti Emilceramica sono realizzati con le più moderne tecnologie disponibili nel settore ceramico allo scopo di ottenere elevate prestazioni qualitative. Con una pressione applicata di oltre 400 kg/cm², il grés porcellanato di Emilceramica ottiene elevate caratteristiche tecniche che permettono l’utilizzo sia in ambito commerciale, ad alto traffico e carrabilità, sia in ambito residenziale, date le particolari doti estetiche.

Il rigido controllo del ciclo di cottura e l'accurata selezione delle materie prime utilizzate a protezione della superficie, determinano una altissima resistenza all'usura e di conseguenza una totale versatilità di utilizzo.

Il rispetto delle prescrizioni suggerite consentirà di preservare inalterate nel tempo le caratteristiche tecniche ed estetiche del grés porcellanato acquistato.

REQUISITI PER L’USO

Emilceramica products are manufactured using technologies at the ceramics industry state of the art, in order to deliver impressive quality performance. Subjected to a pressure of more than 400 kg/cm², Emilceramica porcelain stoneware has excellent technical characteristics that make it suitable for use both in commercial locations, with heavy use or vehicle traffic, and in the home, thanks to its exquisite appearance.

The strict control of the firing cycle and careful selection of the raw materials used to protect the surface provide outstanding resistance to wear and thus total versatility in use. Compliance with the manufacturer’s recommendations will ensure that the porcelain stoneware purchased maintains all its technical and appearance features over time.

REQUISITI PER L’USO

Les produits Emilceramica sont réalisés en faisant appel aux technologies les plus modernes disponibles dans le secteur céramique afin d’obtenir les meilleures prestations en matière de qualité. Avec une pression appliquée de plus de 400 kg/cm², le grès cérame d’Emilceramica possède d’excellentes caractéristiques techniques qui permettent de l'utiliser dans les commerces fortement fréquentés et soumis à de nombreux passages de clientèle, ainsi que dans le secteur résidentiel étant donné ses extraordinaires qualités esthétiques.

Le contrôle rigoureux du cycle de cuisson et la sélection soignée des matières premières utilisées pour la protection des surfaces entraînent une très forte résistance à l’usure et, par conséquent, une totale polyvalence d’utilisation des produits Emilceramica.

Le respect des instructions données permettra de conserver durablement les caractéristiques techniques et esthétiques des produits en grés cérame achetés.

REQUISITI PER L’USO

Die Emilceramica Produkte werden mit den modernsten in der Keramikbranche verfügbaren Technologien hergestellt, um qualitativ hochwertige Performances zu gewährleisten. Der hierbei angewandte Druck von über 400 kg/cm² verleiht dem Emilceramica Feinsteinzeug ausgezeichnete technische Eigenschaften, die eine Verlegung in Gewerbebereichen mit intensiver Beanspruchung und hohem Fahrzeug- und Personenaufkommen erlauben. Dank der besonderen ästhetischen Vorzüge bietet sich auch die Verlegung in Wohnbereichen an.

Die strenge Kontrolle des Brennzyklus und die sorgfältige Auswahl der zum Schutz der Oberfläche verwendeten Rohstoffe garantieren eine sehr hohe Verschleißfestigkeit, wodurch das Produkt praktisch überall eingesetzt werden kann. Die Einhaltung der empfohlenen Vorschriften gewährleistet, dass die technischen und ästhetischen Eigenschaften des erworbenen Feinsteinzeugs langfristig unverändert bleiben.

REQUISITI PER L’USO

Los productos de Emilceramica se realizan con las tecnologías más modernas que ofrece la industria cerámica, a fin de obtener un alto rendimiento desde el punto de vista de la calidad. Con las exelentes características técnicas que le confiere la presión de prensado de más de 400 kg/cm², el gres porcelánico de Emilceramica puede utilizarse en ámbito comercial (zonas con tránsito peatonal y tráfico rodado intensos), así como en usos residenciales gracias a sus especiales cualidades estéticas. El severo control del ciclo de cocción y la selección atenta de las materias primas utilizadas para proteger la superficie se traduoen en una altísima resistencia al desgaste y, por consiguiente, una versatilidad de uso total. El cumplimiento de las recomendaciones indicadas permitirá mantener inalteradas las características técnicas y estéticas del gres porcelánico comprado.

REQUISITI PER L’USO

Продукция Emilceramica производится с использованием самых современных технологий, существующих в керамической промышленности, для получения высоких характеристик качества. При прикладываемом давлении свыше 400 кг/см² керамогранит Emilceramica приобретает высокие технические характеристики, позволяющие использовать его как в коммерческой среде с интенсивным трафиком и движением транспортных средств, так и в жилом секторе, ввиду его высоких эстетических свойств.

Жесткий контроль цикла обжига и тщательный отбор использованного сырья, защищающего поверхности, обеспечивает высочайшую износостойкость, следовательно, полную универсальность использования.

Соблюдение рекомендаций позволит сохранить неизменными во времени технические и эстетические характеристики приобретенного вами керамогранита.

REQUISITI PER L’USO

REQUISITI PER L’USO

REQUISITI PER L’USO

REQUISITI PER L’USO

	Alto traffico urbano ed industriale (es. magazzini, depositi, fabbriche).	Heavy urban and industrial traffic (e.g. warehouses, stores, factories).	Passage intense urbain et industriel (ex. entrepôts, dépôts, usines).	Starker städtischer und gewerblicher Verkehr (z.B. Lager, Depots, Fabriken).	Alto tráfico urbano e industrial (por ej. almacenes, depósitos, fábricas).	Интенсивное движение городских и промышленных транспортных средств (напр., склады, хранилища, предприятия).
	Alto traffico pedonale (es. stazioni ferroviarie, aeroporti, centri commerciali).	Heavy pedestrian traffic (e.g. railway stations, airports, retail malls).	Piétinement intense (ex. gares, aéroports, centres commerciaux).	Starker Fußgängerverkehr (z.B. Bahnhöfe, Flughäfen, Einkaufszentren).	Alto tráfico peatonal (por ej. estaciones de tren, aeropuertos, centros comerciales).	Интенсивное пешеходное движение (напр., железнодорожные вокзалы, аэропорты).
	Medio traffico per ambienti pubblici (es. ristoranti, uffici, negozi).	Medium traffic levels for public premises (e.g. restaurants, offices, shops).	Passage modéré pour lieux publics (ex. restaurants, bureaux, magasins).	Mittelstarker Verkehr in öffentlichen Bereichen (z.B. Gaststätten, Büros, Geschäfte).	Tráfico medio en espacios públicos (por ej. restaurantes, oficinas, tiendas).	Среднее движение в общественных местах (напр., рестораны
	Ambienti residenziali (es. zona giorno, zona notte, camere di alberghi, bagni).	Residential rooms (e.g. living-rooms, bedrooms, hotel rooms, bathrooms).	Espaces résidentiels (ex. cuisine, salle à manger, chambres à coucher, salles de bains).	Privatbereiche (z.B. Wohnbereich, Schlafbereich, Hotelzimmer, Badbereich)	Ámbitos residenciales (por ej. zona de día, zona de noche, habitaciones de hotel, baños)	Жилые объекты (напр., гостиные, спальни, гостиничные номера, ванные)

REQUISITI PER L’USO

EMILCERAMICA

IL TAGLIO DELLE PIASTRELLE IN GRES PORCELLANATO

Cutting porcelain stoneware tiles | La decoupe des carreaux en gres cerame |Schneiden von Feinsteinzeugfliesen

Corte de los azulejos de gres porcelánico | Резка керамогранитной плитки

REQUISITI PER L’USO

La gamma Emilceramica in gres porcellanato viene realizzata con le più moderne tecnologie disponibili sul mercato al fine di ottenere valori assai ridotti di assorbimento d’acqua; secondo gli standard UNI EN ISO 10545-3/ ASTM C373 per essere definito “gres porcellanato” il prodotto ceramico deve riportare valori di assorbimento ≤ 0,5% (Gruppo “Bla” secondo la norma ISO 13006, Classe “P1” secondo la ANSI A 137. 1), sebbene i prodotti Emilceramica siano normalmente realizzati a valori inferiori. Tale caratteristica consente di ottenere pavimenti dalle elevate prestazioni di tenacità e resistenza alla flessione e quindi idonei ad un utilizzo sottoposto ad elevata sollecitazione meccanica e traffico sostenuto. Il basso assorbimento è altresì garanzia di resistenza al gelo, così come definito dallo standard UNI EN ISO 10545- 12 o dalla normativa americana ASTM C1026. La tenacità superficiale comporta in taluni casi una certa resistenza della superficie ceramica in fase di taglio. L’osservanza di alcune prescrizioni basilari consente di ridurre gli scarti durante la posa e accelerare le operazioni di installazione delle piastrelle.

REQUISITI PER L’USO

The porcelain stoneware Emilceramica range is manufactured using the very latest technologies available on the market, to achieve very low water absorption values; under the UNI EN ISO 10545-3/ ASTM C373 standards, to be defined as “porcelain stoneware” ceramic tiles must have absorption ≤ 0,5% (Group “Bla” under the ISO 13006 standard, Class “P1” under ANSI A 137. 1), although Emilceramica products are generally manufactured to deliver values below this. These characteristics give the floor tiles exceptional toughness and bending strength values, making them suitable for uses subjected to high mechanical stresses and heavy traffic. The low absorption also ensures resistance to frost, as defined by the UNI EN ISO 10545- 12 and ASTM C1026 standards.

In some cases, the toughness of the surface may render the ceramic surface rather hard to cut.

Compliance with a few simple rules will help to reduce waste during laying and speed up tile installation operations.

REQUISITI PER L’USO

La gamme Emilceramica en grés cérame a été réalisée en faisant appel aux technologies les plus modernes disponibles sur le marché afin d’obtenir des valeurs d’absorption d’eau très faibles conformément aux normes UNI EN ISO 10545-3 et ASTM C373. Pour obtenir l’appellation de grés cérame, les produits en céramique doivent posséder des valeurs d’absorption d’eau ≤ 0,5% (Groupe “Bla” selon la norme ISO 13006, Classe “P1” selon la norme ANSI A 137. 1). Les produits Emilceramica sont normalement fabriqués avec des taux inférieurs. Cette caractéristique permet d’obtenir des sols offrant d’excellentes prestations, en termes de solidité et de résistance à la flexion, en mesure d’être utilisés pour des applications prévoyant de fortes contraintes mécaniques et des passages élevés de personnes. Le faible taux d’absorption de l’eau constitue également un gage de résistance au gel définie par les normes UNI EN ISO 10545-12 et ASTM C1026. La solidité de la surface des carreaux entraîne parfois une certaine résistance de la surface céramique lors de la phase de coupe. Le respect des instructions de base reportées ci-dessous permet de réduire les rebuts durant la pose et d’accélérer les opérations d’installation des carreaux.

REQUISITI PER L’USO

Die Feinsteinzeugserie Emilceramica wird unter Anwendung der modernsten am Markt verfügbaren Technologien hergestellt, um sehr niedrige Wasseraufnahmewerte zu gewährleisten. Nach den Vorgaben der Normen UNI EN ISO 10545-3 und ASTM C373 muss ein Keramikprodukt Wasseraufnahmewerte ≤ 0,5% (Gruppe „Bla“ gemäß Norm ISO 13006, Klasse „P1“ gemäß Norm ANSI A 137. 1) aufweisen, um als „Feinsteinzeug“ definiert werden zu können. Dies trifft in jeder Hinsicht für die Emilceramica Produkte zu, die sich in der Regel durch noch niedrigere Werte auszeichnen. Dadurch erhält man Bodenbeläge mit sehr hohen Bruch- und Biegefestigkeitswerten, die sich hervorragend für Bereiche mit intensiver mechanischer Beanspruchung und hohem Fahrzeug- und Personenaufkommen eignen. Der niedrige Wasseraufnahmewert ist ferner die Garantie für eine entsprechende Frostbeständigkeit, wie sie in der Norm UNI EN ISO 10545-12 oder ASTM C1026 festgelegt ist. Die Festigkeit der Keramikoberfläche leistet in bestimmten Fällen einen gewissen Widerstand, muss die Fliese geschnitten werden. Durch die Einhaltung einiger grundlegender Vorschriften vermeidet man unnötigen Abfall während der Arbeit und beschleunigt somit die Verlegung der Fliesen.

REQUISITI PER L’USO

La gama Emilceramica de gres porcelánico se realiza sirviéndose de las tecnologías más modernas que ofrece el mercado, a fin de obtener unos valores muy reducidos de absorción de agua. Según las normas UNI EN ISO 10545-3 y ASTM C373, para poder llamarlo «gres porcelánico», el producto cerámico debe tener un valor de absorción ≤ 0,5% (Grupo Bla según la norma ISO 13006, clase P1 según la norma ANSI A 137. 1). Por lo general, los productos Emilceramica se realizan con valores inferiores, lo que permite obtener pavimentos con un alto valor de tenacidad y resistencia a la flexión, perfectos para los usos sujetos a grandes tensiones mecánicas y tráfico intenso. Además, su bajo valor de absorción garantiza la resistencia a las heladas, tal como establece la norma UNI EN ISO 10545-12 o la ASTM C1026. En algunos casos, la tenacidad superficial implica que la superficie cerámica oponga una cierta resistencia durante la fase de corte. El cumplimiento de algunas recomendaciones básicas permitirá reducir los desechos durante la colocación y agilizar las operaciones de instalación de los azulejos.

REQUISITI PER L’USO

Гамма Emilceramica из керамогранита производится с использованием самых современных технологий из имеющихся на рынке с целью получения очень низких значений впитывания воды. В соответствии со стандартом UNI EN ISO 10545-3/ ASTM C373 керамогранитом называется керамическая продукция со значениями впитывания ≤ 0.5% (Группа “Bla” по нормe ISO 13006, Класс “P1” в соответствии с ANSI A 137.1), несмотря на то, что продукция Emilceramica, как правило, выпускается с более низкими значениями. Эта характеристика позволяет получать полы с высокими характеристиками стойкости и прочности на изгиб, следовательно, пригодными к использования с высокими механическими нагрузками и интенсивным трафиком. Кроме того, низкое впитывание воды - это гарантия морозостойкости, как определяется стандартом UNI EN ISO 10545-12 или ASTM C1026. Прочность поверхности приводит в некоторых случаях к определенному сопротивлению керамической поверхности во время резки. Соблюдение некоторых основных рекомендаций позволяет снизить количество отходов во время укладки и ускорить работы по укладке плитки.

EMILCERAMICA

IL TAGLIO DELLE PIASTRELLE IN GRES PORCELLANATO - PRESCRIZIONI BASILARI

Cutting porcelain stoneware tiles - Fundamental rules | La découpe des carreaux en gres cerame - Instructions de base | Schneiden von Feinsteinzeugfliesen - Grundlegende Vorschriften | Corte de los azulejos de gres porcelánico - Recomendaciones básicas | Резка керамогранитной плитки - Основные рекомендации



Stato della taglia-piastrelle Verificare che la meccanica sia in buono stato. Accertarsi che la lama di incisione non sia eccessivamente consumata e abbia perso la sua taglienza. Controllare che non vi siano vibrazioni anomale tra le componenti meccaniche, gli scorrimenti e i perni di fissaggio. È consigliabile lubrificare costantemente la lama.

State of the tile-cutter Check that the tool to be used is in good working order. Make sure that the blade is not too worn or blunt. Check the mechanical components, moving parts and fixing pins for excessive vibration. The blade should be constantly lubricated.

Etat du decoupeur de carreaux Vérifier que l'appareil soit en parfait état. Vérifier que la lame de coupe ne soit pas excessivement usée et n'ait pas perdu son pouvoir de coupe. Vérifier qu'il n'y ait aucune vibration anormale entre les composants mécaniques, les guides et les goupilles de fixation de l'appareil. Il est conseillé de lubrifier constamment la lame.

Zustand des Fliesenschneidergeräts Prüfen, ob keine mechanische Mängel vorliegen. Sicherstellen, dass das Schneidrad nicht zu sehr abgenutzt ist und seine Schneidleistung nicht eingebüßt hat. Prüfen, ob keine ungewöhnlichen Vibrationen zwischen den

mechanischen Komponenten, den Gleiteilen und den Befestigungsbolzen zu verzeichnen sind. Es empfiehlt sich, das Schneidrad regelmäßig zu schmieren.

Estado del cortador Comprobar que los componentes mecánicos estén en buen estado. Asegurarse de que la rulina no esté demasiado consumida y que no haya perdido su capacidad de rayado. Comprobar que no se produzcan vibraciones anómalas en los componentes mecánicos, las guías de deslizamiento y los pernos de fijación. Es aconsejable lubricar continuamente la rulina.

Состояние плиткореза Проверьте хорошее состояние механической части плиткореза. Убедитесь, что режущий ролик не износился и не затупился. Проверьте отсутствие аномальной вибрации в механических компонентах, в узлах скольжения и крепежных пальцах. Рекомендуется постоянно смазывать полотно.



Manualità Accertarsi di esercitare una pressione costante dell'incisore sull'intera superficie del pezzo. Per il taglio di prodotti particolarmente tenaci è opportuno realizzare una doppia incisione (doppio passaggio). Per agevolare l'incisione occorre regolare l'altezza del fermo meccanico secondo lo spessore del materiale.

Cutting Skill Ensure that the scoring unit applies a constant pressure to the entire surface of the piece. When cutting particularly tough products, two scoring passes should be made. For easier scoring, adjust the height of the mechanical stop as appropriate to the thickness of the material.

Technique de coupe Faire en sorte d'exercer une pression constante sur le découpeur de carreaux et sur toute la surface des carreaux. Pour la coupe de produits particulièrement résistants, il convient de réaliser une double coupe (double passage). Pour faciliter la coupe, il convient de régler la hauteur de la butée mécanique selon l'épaisseur des carreaux à couper.

Handhabung Sicherstellen, dass das Schneidrad mit einem konstanten Druck auf der gesamten Länge der Fliesenoberfläche geführt wird. Zum Schneiden besonders hartnäckiger Fliesen ist ein Doppelschnitt (zweimaliges Einschneiden) auf diesen vorzunehmen. Um den Schnitt einwandfrei ausführen zu können, ist die Höhe des mechanischen Anschlags je nach Stärke des Materials entsprechend einzustellen.

Ejecución Asegurarse de ejercer una presión uniforme con el rodel a lo largo de toda la superficie de la pieza. Para cortar productos especialmente duros, se puede realizar un rayado doble (dos pasadas). Para facilitar el rayado, hay que ajustar la altura del tope mecánico según el grosor del material.

Мастерство Убедитесь, что вы оказываеае постоянный нажим на режущий ролик на всей поверхности изделия. Для резки изделий, обладающих особенной твердостью, рекомендуется выполнять двойной надрез (двойной проход). Для облегчения выполнения надреза следует отрегулировать высоту механического стопора по толщине материала.



Utensili specifici Nel caso in cui si decida di effettuare un taglio con flessibile occorre accertarsi che i dischi siano adatti al taglio del gres porcellanato e che la velocità sia ridotta; è opportuno l'utilizzo di flessibili a velocità variabile.

Specific tools If an angle-grinder is used for cutting, make sure that the discs are suitable for cutting porcelain stoneware and that the tool's rotation speed is low; variable speed tools are recommended.

Outils spécifiques Au cas où l'on choisisse de couper les carreaux avec un découpeur-perceur, il convient de vérifier que les disques soient adaptés à la coupe du grès cérame et que leur vitesse soit réduite. Il est conseillé d'utiliser des découpeurs-perceurs à vitesse variable.

Spezialwerkzeuge Sollen Schnitte mit einem Trennschneider ausgeführt werden, ist sicherzustellen, dass die Scheiben für den Schnitt von Feinsteinzeug ausgelegt sind und hierbei die Drehzahl niedrig gehalten wird; es empfiehlt sich die Verwendung von

Trennschneidern mit variabler Drehzahl.

Herramientas específicas Si se opta por realizar el corte con una amoladora, habrá que comprobar que los discos sean adecuados para cortar gres porcelánico y que se use una velocidad reducida; es oportuno usar amoladoras de velocidad variable.

Специальный инструмент В случае, если вы решите выполнять резку болгаркой, то следует убедиться, что диски пригодны для резки керамогранита, и что скорость резки невысокая. Рекомендуется использовать болгарку с регулировкой скорости.

EMILCERAMICA

IL TAGLIO DELLE PIASTRELLE IN GRES PORCELLANATO - PRESCRIZIONI BASILARI

Cutting porcelain stoneware tiles - Fundamental rules | La découpe des carreaux en gres cerame - Instructions de base | Schneiden von Feinsteinzeugfliesen - Grundlegende Vorschriften | Corte de los azulejos de gres porcelánico - Recomendaciones básicas | Резка керамогранитной плитки - Основные рекомендации



Taglio ad acqua Per una migliore gestione del taglio su gres porcellanato è consigliato l'utilizzo di taglia-piastrelle ad acqua. La macchina ad acqua riduce gli scarti dovuti alla durezza superficiale della piastrella e realizza una migliore qualità del taglio.

Waterjet cutting For the best results when cutting porcelain stoneware, a waterjet tile cutter should be used. With waterjet tools, there are fewer rejects due to the tile's hard surface and the quality of cut is better.

Découpe par jet d'eau Afin d'obtenir une meilleure coupe des carreaux en grès cérame, il est conseillé d'utiliser des découpeurs-perceurs de carreaux à eau. En effet, ces appareils réduisent les rebuts dus à la dureté de la surface des carreaux et permettent d'obtenir une coupe de meilleure qualité.

Wasserstrahlschneiden Beste Schnittergebnisse bei Feinsteinzeug erhält man mit einem Nass-Fliesenschneidergerät. Durch ein mit Wasser arbeitendes Schneidergerät reduziert man das Risiko zahlreicher auf die harte Oberfläche zurückzuführender Fliesenabfälle und gewährleistet eine bessere Schnittqualität.

Corte mediante chorro de agua a presión Para controlar mejor el corte del gres porcelánico, es aconsejable utilizar un cortador refrigerado por agua. El cortador de agua reduce los desechos debidos a la dureza superficial del azulejo y realiza un corte de mejor calidad.

Гидрорезка Для получения наилучших результатов резки керамогранита рекомендуется использовать водяные плиткорезы. Водяные плиткорезы снижают количество отходов, вызванное твердостью поверхности плитки и позволяют получить наилучшее качество резки.



La foratura La foratura per il passaggio di cavi si realizza utilizzando apposite frese diamantate su trapani a velocità variabile; è sempre consigliabile una velocità molto ridotta dell'utensile osservando i necessari tempi di lavoro. Si raccomanda di non continuare ad utilizzare la fresa una volta esaurita la taglienza. Per ottenere un inserto quadrato per l'installazione di scatole elettriche occorre realizzare 4 fori sugli spigoli del perimetro utilizzando una fresa diamantata di piccolo diametro (6-8 mm); in tal modo vengono alleggerite le tensioni interne della piastrella sulla quale, in seguito, si possono effettuare i tagli di congiunzione con un disco diamantato.

Boring Holes to allow the passage of electrical wiring are made using special diamond tools mounted on variable speed drills. The tool rotation speed should always be very low; do not rush this operation. Never keep on using a blunt tool. To make a square opening to fit over an electric wiring box, first drill 4 holes in the corners of the opening with a small-diameter diamond tool (6-8 mm) to reduce the stresses within the tile, after which the cuts between these holes can be made using a diamond disc.

Le perçage Le trou pour le passage des câbles est réalisé en utilisant des meuleuses à disques diamantés à vitesse variable. Il est vivement conseillé d'utiliser les meuleuses à une vitesse très basse, tout en respectant leur durée d'utilisation. Il est, par ailleurs, conseillé de ne pas utiliser des meuleuses dont les lames seraient usées. Pour obtenir une niche carrée dans laquelle loger des boîtiers électriques, il convient de réaliser 4 trous sur les arêtes du périmètre en utilisant une meuleuse à disques diamantés de faible diamètre (6-8 mm). L'utilisation de ces outils permettra de réduire les tensions internes des carreaux sur lesquels il sera ensuite possible d'effectuer les coupes de jointure avec un disque diamanté.



Bohren Bohrungen zur Durchführung von Kabeln sind mit geeigneten Diamantfräsen auf Bohrmaschinen mit variabler Drehzahl auszuführen; unter Berücksichtigung der erforderlichen Arbeitszeiten sollte stets eine relativ niedrige Werkzeugdrehzahl gewählt werden.

Abgenutzte oder verschlissene Fräsen dürfen auf keinen Fall weiter verwendet werden. Zum Erhalt eines quadratischen Ausschnitts für die Installation von Stromdosen sind 4 Bohrungen an den umfängsseitigen Kanten unter Verwendung einer Diamantfräse mit kleinem Durchmesser (6-8 mm) auszuführen; auf diese Weise werden die inneren Spannungen der Fliese abgeschwächt, und es ist anschließend möglich, die Verbindungsschnitte zwischen den Bohrungen mit einer Diamantscheibe auszuführen.

La perforación El agujero redondo para pasar cables se hace con brocas diamantadas especiales montadas en taladros de velocidad variable; siempre es aconsejable emplear la herramienta a muy baja velocidad, respetando el tiempo necesario para realizar el trabajo. No se recomienda seguir usando la broca una vez que haya perdido su capacidad de rayado. Para obtener un agujero cuadrado donde instalar cajas de enchufe, hay que practicar 4 orificios en las esquinas del perímetro con una broca diamantada de diámetro pequeño (6-8 mm). Esto permite reducir las tensiones internas del azulejo sobre el cual posteriormente se podrá realizar los cortes de unión con un disco diamantado.

Сверление Изготовление отверстий для пропускa кабелей выполняется с использованием специальных алмазных фрез и дрелей с регулировкой скорости. Всегда рекомендуется использовать очень низкую скорость инструмента, соблюдая необходимую скорость выполнения работ. Не рекомендуется продолжать использовать фрезу после того, как она затупилась. Для выполнения квадратных вырезов для установки электрических коробок следует выполнить 4 отверстия по углам периметра, используя алмазную фрезу маленького диаметра (6-8 мм). Таким образом снижается внутреннее напряжение плитки, на которой потом можно будет выполнить резку между отверстиями алмазным диском.

EMILCERAMICA

CONDIZIONI GENERALI DI VENDITA E GARANZIE

1. Disposizioni Generali

- 1.1 In aggiunta ai termini e alle locuzioni definiti altrove nelle presenti Condizioni Generali di Vendita (infra definite), i termini e le locuzioni di seguito elencati hanno – quando indicati con la lettera iniziale maiuscola – il significato ad essi convenzionalmente attribuito o richiamato nel presente art. 1.1:
- "Acquirente"**: la persona, fisica o giuridica, dalla quale il Venditore (infra definito) riceve l'ordine di acquisto;
 - "Contratto"**: l'ordine di acquisto dell'Acquirente, accettato dal Venditore, comprensivo delle Condizioni Generali di Vendita (infra definite);
 - "EXW"**: la disciplina di diritti e obblighi di Acquirente e Venditore (infra definito) prevista, con riferimento all'acronimo di Ex Works (Franco Fabbrica), dagli Incoterms 2020 della Camera di Commercio Internazionale di Parigi;
 - "Parti"**: l'Acquirente e il Venditore ongiuntamente;
 - "Prodotti"**: i prodotti del Venditore come risultanti dai listini e cataloghi di anno in anno vigenti;
 - "Venditore"**: Emilceramica S.r.l. a socio unico, con sede legale in Via Ghiarola Nuova, 29 – 41042 Fiorano Modenese (MO), Italia.
- 1.2 I termini e le condizioni qui di seguito indicati (le "Condizioni Generali di Vendita") formano parte integrante e sostanziale di ciascun Contratto concluso tra il Venditore e l'Acquirente per la compravendita dei Prodotti e prevalgono su eventuali condizioni predisposte dall'Acquirente, salvo espressa accettazione scritta di queste ultime da parte del Venditore.
- 1.3 Il Venditore si riserva il diritto di modificare, integrare o variare le Condizioni Generali di Vendita, allegando tali variazioni alle offerte ovvero a qualsivoglia comunicazione scritta all'Acquirente. Laddove le modifiche, integrazioni o variazioni delle Condizioni Generali di Vendita non siano accettate dall'Acquirente entro 15 giorni dalla data di comunicazione, varranno le Condizioni Generali di Vendita precedentemente accettate, salva la facoltà di recesso del Venditore entro i 30 giorni successivi.

2. Offerte e Ordini

- 2.1 L'offerta fatta all'Acquirente da agenti, procacciatori o da altri intermediari e la proposta d'ordine da essi inoltrata al Venditore non vincola quest'ultimo fino a quando l'ordine dell'Acquirente non sia accettato dal Venditore ai sensi del successivo art. 2.2.
- 2.2 L'ordine effettuato dall'Acquirente non si intende accettato finché non è confermato per iscritto dal Venditore. Nel caso in cui il Venditore non provveda alla conferma per iscritto di un ordine, l'emissione della fattura ovvero l'esecuzione dell'ordine da parte del Venditore deve intendersi quale accettazione.

3. Termini di Consegna

- 3.1 La consegna dei Prodotti avviene EXW. Il Venditore effettua la consegna mettendo i Prodotti a disposizione dell'Acquirente nei termini e nei luoghi specificati nel Contratto (la "Consegna"). All'atto della Consegna il Venditore assume esclusivamente l'obbligo di caricare i Prodotti sul veicolo di prelevamento, restando escluso qualsiasi ulteriore obbligo.
- 3.2 Il Venditore non è responsabile per qualsiasi perdita o danno ai Prodotti dopo la Consegna; in nessun caso l'Acquirente è esonerato dall'obbligo di pagamento del prezzo dei Prodotti una volta avvenuta la Consegna.
- 3.3 Fatti salvi i rimedi di cui al successivo art. 9, la Consegna può essere sospesa in tutti i casi di inadempimento dell'Acquirente all'obbligo di pagamento del prezzo dei Prodotti.
- 3.4 Tutti i termini temporali di consegna e resa dei Prodotti - anche se definiti come tassativi - si intendono comunque indicativi e assunti dal Venditore con ogni tolleranza d'uso. Il termine di Consegna - comunque indicativo - è solo ed esclusivamente quello precisato nella conferma d'ordine del Venditore.
- 3.5 In caso di ritardo nella Consegna che ecceda la tolleranza d'uso, l'Acquirente può annullare soltanto la parte dell'ordine relativa ai Prodotti la cui Consegna non avvenga entro i 30 giorni successivi alla data di ricevimento da parte del Venditore della comunicazione di annullamento dell'Acquirente, da inviarsi a mezzo raccomandata A/R o PEC.
- 3.6 L'Acquirente non può annullare il proprio ordine, né recedere dal Contratto, in caso di ritardata Consegna dipendente da eventi di forza maggiore, di cui al successivo art. 6, qualora il ritardo nella Consegna non ecceda 60 giorni.
- 3.7 Il Venditore può recedere dal Contratto mediante comunicazione scritta all'Acquirente nel caso di eventi di forza maggiore di cui al successivo art. 6.
- 3.8 Se la Consegna non avviene per fatto imputabile all'Acquirente essa si intende eseguita, ad ogni effetto (compresa la decorrenza dei termini di pagamento e l'emissione della fattura), con semplice comunicazione all'Acquirente di messa a disposizione dei Prodotti; trascorsi 15 giorni dalla comunicazione decorrono le spese di magazzino e il Venditore è esonerato da qualsiasi responsabilità per il perimento, il danneggiamento o, comunque, la perdita di valore dei Prodotti.
- 3.9 L'Acquirente si obbliga a comunicare al Venditore la mancata consegna dei Prodotti presso il luogo di destinazione indicato nel documento di trasporto ovvero l'avvenuta consegna dei Prodotti in luogo diverso da quello indicato nel documento di trasporto entro le 120 ore successive alla data prevista per la consegna presso il

luogo di destinazione, mediante raccomandata A/R o PEC contenente altresì la copia del documento di trasporto sottoscritto. A seguito della ricezione della predetta comunicazione comprensiva della documentazione, il Venditore provvede alla regolarizzazione delle fatture emesse con applicazione dell'IVA ex DPR n. 600/1973. Resta inteso che l'Acquirente si impegna a tenere indenne il Venditore per imposte, sovrattasse, interessi e sanzioni di qualsiasi genere, oltre alle spese legali, nel caso di addebiti effettuati dall'Amministrazione Finanziaria a suo carico derivanti da tale mancata comunicazione per iscritto o comunque dalla consegna dei Prodotti presso il luogo di destinazione diverso da quello indicato nel documento di trasporto. L'Acquirente, preso atto della comunicazione che il Venditore richiede di sottoscrivere al vettore, si impegna altresì a comunicare al vettore stesso ogni cambio o modifica di destinazione dei Prodotti. L'inadempimento del predetto obbligo comporta l'addebito da parte del Venditore all'Acquirente di eventuali imposte, sovrattasse, interessi e sanzioni di qualsiasi genere, nonché degli oneri di natura legale, in caso di rilievi dell'Amministrazione Finanziaria conseguenti a tale mancata comunicazione.

3.10 Fatti salvi i casi di dolo o colpa grave, è esclusa qualsiasi responsabilità del Venditore per danni derivanti da ritardata o mancata Consegna (totale o parziale) dei Prodotti.

4. Prezzi e Termini di Pagamento

- 4.1 I prezzi dei Prodotti indicati nei listini anno per anno vigenti si intendono EXW; ne consegue che qualsiasi altro onere o spesa relativi a spedizione, consegna e/o trasporto dei Prodotti sono a esclusivo carico dell'Acquirente. La provvista necessaria per far fronte a eventuali oneri e spese a carico dell'Acquirente dovrà, nel caso, essere da quest'ultimo anticipata al Venditore; a mero titolo esemplificativo ma non esaustivo, tali spese ed oneri ricomprendono il costo di imballaggio aggiuntivo, il costo di trasporto, gli oneri accessori, le imposte, i bolli, le spese doganali e ogni altro onere aggiuntivo non compreso nei prezzi. I prezzi dei Prodotti possono essere soggetti a correzioni dovute a errori di stampa.
- 4.2 I prezzi dei Prodotti si intendono al netto di IVA di legge, che deve essere corrisposta in conformità a quanto indicato in fattura.
- 4.3 Il luogo di pagamento è fissato presso la sede legale del Venditore anche nel caso di emissione di tratte o ricevute bancarie, ovvero di rilascio di effetti cambiali. L'eventuale accettazione da parte del Venditore di cambiali, pagherò, cessioni o assegni bancari si intende sempre convenuta salvo buon fine e/o pro solvendo e senza no-vazione del debito. Il pagamento è dovuto integralmente all'atto della Consegna dei Prodotti, salvo diversa pattuizione scritta.
- 4.4 In aggiunta agli altri rimedi previsti dalla legge e/o dal Contratto, il Venditore applica interessi di mora sui ritardati pagamenti in conformità a quanto previsto dal d.lgs. n. 231 del 2002.

5. Termini di Garanzia

- 5.1 Il Venditore garantisce che i Prodotti sono esenti da vizi e difetti per un periodo di 12 mesi dalla consegna. La garanzia opera nei limiti di cui all'art. 1495 c.o., fatte salve le ulteriori limitazioni di cui al presente articolo e alla raccolta provinciale degli usi 2005 della Camera di Commercio di Modena per i materiali ceramici, nonché le tolleranze d'uso. Le eventuali indicazioni di pesi, misure, dimensioni, colori, tonalità e altri dati contenuti in cataloghi, depliant, e folder del Venditore hanno carattere meramente indicativo e non sono vincolanti. La garanzia del Venditore è in ogni caso limitata ai Prodotti di prima scelta e cioè – secondo quanto indicato dalla raccolta provinciale degli usi 2005 della Camera di Commercio di Modena per i materiali ceramici – con una percentuale di piastrelle difettose non superiore al 5%, soltanto per la parte eccedente tale percentuale, mentre la garanzia è espressamente esclusa per i Prodotti diversi da quelli di prima scelta. Fatti salvi i casi di dolo e colpa grave, le differenze di tonalità rispetto a quanto eventualmente convenuto non possono essere denunciate come vizio dei Prodotti.
- 5.2 Con l'obbligazione di garanzia il Venditore si impegna a sostituire il prodotto viziato e/o difettoso nei limiti del Contratto e comunque senza alcun ulteriore obbligo di risarcimento del danno diretto e/o indiretto e/o consequenziale derivante all'Acquirente e/o a terzi da difetti dei Prodotti, fatte salve le disposizioni inderogabili di legge. In ogni caso le Parti riconoscono che la responsabilità complessiva del Venditore nei confronti dell'Acquirente è limitata al prezzo pagato dall'Acquirente per i Prodotti che hanno dato origine alla responsabilità del Venditore.
- 5.3 In ogni caso la garanzia per i vizi e i difetti viene meno con la posa in opera dei Prodotti; pertanto i reclami devono essere effettuati prima della posa in opera mediante lettera raccomandata A/R o PEC da indirizzarsi al Venditore e devono documentare dettagliatamente i vizi e i difetti riscontrati. Il reclamo non dà diritto all'Acquirente di sospendere o ritardare, in tutto o in parte, il pagamento nei termini di Contratto.
- 5.4 Resta inteso che la garanzia di cui al presente articolo è esclusa dalla posa in opera nonché ove il vizio e/o il difetto dei Prodotti dipendano dall'uso non corretto, dalla modifica o alterazione dei Prodotti medesimi, imputabili all'Acquirente.

6. Forza Maggiore

- 6.1 Il Venditore può sospendere l'esecuzione del e/o recedere dal Contratto qualora l'adempimento risulti oggettivamente impossibile o eccessivamente oneroso a causa di un evento imprevedibile indipendente dalla sua volontà quali, ad esempio, sciopero, controversia sindacale, incidente, esplosione, boicottaggio, serrata, incendio, guerra, guerra civile, sommossa e rivoluzione, epidemia, requisizione, embargo, interruzione di energia, inondazione, atto od omissione di legge o di governo, atto di terrorismo, ritardo o impossibilità di approvvigionamento dei propri fornitori, guasti a macchinari o attrezzature essenziali e altre cause analoghe a quelle sopraelencate.
- 7. Anticorruzione. Codice Etico**
- 7.1 L'Acquirente osserva le previsioni di ogni legge, regolamento, direttiva applicabili di qualsiasi autorità, ente governativo o altra istituzione nazionale o internazionale con riguardo a pratiche ed illeciti di natura corruttiva (la "Legge Applicabile"), incluse le leggi riguardanti pagamenti illeciti, offerte, promesse di denaro o qualsiasi altro beneficio a favore di pubblici ufficiali o incaricati di pubblico servizio per l'espletamento delle loro funzioni o poteri.
- 7.2 In particolare, l'Acquirente osserva le previsioni dettate dal *U.S. Foreign Corrupt Practices Act*, dalla *Convention on Combating Bribery of Foreign Officials in International Business Transactions* del 1997 ed ogni altra Legge Applicabile con riguardo alla corruzione.
- 7.3 L'Acquirente si impegna per sé e per i propri funzionari, amministratori, lavoratori, collaboratori o consulenti, affinché non sia compiuta, direttamente o indirettamente, qualsiasi azione nell'esecuzione di qualsiasi contratto che possa costituire illecito come previsto da qualsiasi Legge Applicabile ed in particolare l'Acquirente si impegna per sé e per i propri funzionari, amministratori, lavoratori, collaboratori o consulenti affinché non sia offerto, dato o autorizzato a) qualsiasi dazione o pagamento o regalia o ogni altro beneficio a pubblici ufficiali o incaricati di pubblico servizio, dipendenti o agenti di qualsiasi autorità, ente governativo, e di qualsiasi altra istituzione nazionale e internazionale; b) qualsiasi contributo, di qualunque natura, a chiunque sia candidato allo svolgimento di un incarico pubblico.
- 7.4 L'Acquirente osserva le previsioni di cui al D.lgs. 231/2001, come modificato e integrato. A tal fine, l'Acquirente dichiara di conoscere il Codice Etico del Venditore (il "Codice Etico"), e il Modello di organizzazione gestione e controllo previsto dal D.lgs. 231/2001 (il "Modello"). Il Codice Etico, il Codice di Condotta ed il Modello possono essere consultati al seguente sito web: **https://www.emilgroup.it/downloadarea/**. Il Venditore si impegna ad effettuare gli ordini secondo quanto previsto nelle presenti Condizioni Generali di Vendita e in conformità al Codice Etico e al Modello.
- 7.5 L'Acquirente si impegna per sé e per i propri funzionari, amministratori, lavoratori, collaboratori o consulenti che entrano in contatto con il Venditore nell'esecuzione dei Contratti, affinché sia informato il responsabile del Venditore di ogni atto, fatto o azione di cui possano venire a conoscenza e possano costituire reato previsto nel d.lgs. 231/2001 o che, comunque, possano implicare la responsabilità amministrativa del Venditore ai sensi di tale legge.
- 7.6 Se durante l'esecuzione del Contratto l'Acquirente incorre in una condotta descritta nell'art. 2635 c.o., il Venditore ha il diritto di risolvere il Contratto, ai sensi dell'art. 1456 c.o.
- 7.7 In caso di violazione dell'Acquirente di alcuno degli obblighi di cui agli artt. 7.3 e 7.5, il Venditore ha il diritto di risolvere il Contratto, ai sensi dell'art. 1456 c.o.
- 7.8 L'Acquirente dichiara e garantisce che non è stato designato, né è controllato da o associato con qualsiasi soggetto incluso nelle liste dei soggetti di cui agli elenchi restrittivi di U.S.A., U.E. o di qualsiasi altro paese, ivi incluso, senza limitazioni, il *U.S. Treasury Department Office of Foreign Assets Control's Specially Designated Nationals and Blocked Persons List*; e l'Acquirente si impegna a non vendere o trasferire ad altro titolo Prodotti ai suddetti soggetti. L'Acquirente dichiara di osservare le prescrizioni relative alle sanzioni economiche, nonché a leggi, regolamenti di controllo sull'esportazione vigenti in U.S.A., U.E., e in ogni altro paese, inclusi senza limitazioni, i regolamenti disciplinati dall'*Office of Foreign Assets Control*.
- 7.9 In caso di violazione ad opera dell'Acquirente di alcuno degli obblighi, dichiarazioni e garanzie di cui al precedente art. 7.8 il Venditore ha il diritto di risolvere il Contratto, ai sensi dell'art. 1456 c.o.

8. Protezione dei Dati Personali

8.1 Ai fini dell'esecuzione del Contratto le Parti si impegnano a conformarsi ad ogni obbligo previsto dal Regolamento Generale (UE) 2016/679 concernente la "tutela delle persone fisiche con riguardo al trattamento dei dati personali e la libera circolazione di tali dati" (di seguito "GDPR"), nonché, nei limiti della relativa applicabilità, al D. Lgs. 196/2003 ("Codice Privacy"), come da ultimo modificato dal D. Lgs. 101/2018 ed ai provvedimenti dell'Autorità Garante per la protezione dei dati personali.

8.2 Con l'accettazione del presente Contratto, ciascuna Parte, per quanto di rispettiva competenza, riconosce che i dati personali propri e/o dei propri dipendenti e/o collaboratori, coinvolti nelle attività esecutive del Contratto, potranno essere comunicati alla controparte e da quest'ultima trattati in qualità di Titolare autonomo del trattamento per finalità strettamente funzionali alla instaurazione e all'esecuzione del Contratto.

8.3 In particolare, l'Acquirente riconosce che i dati personali propri e/o dei propri dipendenti e/o collaboratori, coinvolti nelle attività di cui al Contratto, saranno trattati dal Venditore in qualità di Titolare autonomo del trattamento per le finalità e secondo le modalità indicate nell'"Informativa Clienti" resa ai sensi dell'art. 13 e 14 del GDPR disponibile sul sito

web www.emilgroup.it alla voce Privacy, che l'Acquirente si impegna sin da ora a portare a conoscenza dei propri dipendenti e/o collaboratori.

9. Cessazione del Contratto

9.1 Il Venditore ha il diritto di risolvere ciascun Contratto con l'Acquirente, con effetto immediato, ai sensi dell'art. 1456 c.o., mediante comunicazione inviata a mezzo raccomandata con la quale dichiara di volersi avvalere della presente clausola risolutiva espressa, nei seguenti casi:

- a) qualora l'Acquirente non adempia agli obblighi di cui agli artt. 3.9, 4 e 7 delle presenti Condizioni Generali di Vendita;
- b) qualora l'Acquirente si renda responsabile di un grave inadempimento contrattuale.

9.2 Il Venditore ha il diritto di recedere con effetto immediato da ciascun Contratto mediante comunicazione inviata a mezzo raccomandata all'Acquirente, con la quale dichiara di volersi avvalere della presente clausola:

- a) nei casi di cui agli artt. 1.3, 3.7, 6.1.
- b) l'Acquirente sia assoggettato a procedure esecutive, concorsuali o di liquidazione;
- c) le condizioni patrimoniali, economiche e finanziarie dell'Acquirente siano tali da far ragionevolmente presumere lo stato di crisi dell'Acquirente;
- d) le azioni e/o la quota rappresentativa della maggioranza o del controllo del capitale sociale dell'Acquirente, ove costituito in forma societaria, siano direttamente o indirettamente cedute, alienate o vincolate a garanzia.

10. Riserva di Proprietà

Il Venditore conserva la proprietà dei Prodotti fino al pagamento integrale del prezzo pattuito. Di conseguenza l'Acquirente si obbliga a i) farne buon uso, secondo la loro destinazione; ii) non trasferirne a terzi la proprietà ed il godimento, salvo che non sia a ciò espressamente e preventivamente autorizzato dal Venditore. Nel caso di mancato pagamento integrale o anche parziale delle forniture da parte dell'Acquirente, entro la data prevista, il Venditore potrà rientrare in possesso dei prodotti consegnati, e ciò a sua semplice richiesta. Nonostante quanto sopra, l'Acquirente è responsabile di qualsiasi eventuale danno e perdita verificatisi dopo la consegna anche se per caso fortuito, forza maggiore o per altri eventi non imputabili all'Acquirente.

11. Legge Applicabile – Foro Competente

- 11.1 Le presenti Condizioni Generali di Vendita e ciascun Contratto stipulato dall'Acquirente con il Venditore è regolato dalla legge Italiana.
- 11.2 Qualsiasi controversia insorta tra le Parti circa l'interpretazione, la validità o l'esecuzione delle presenti Condizioni Generali di Vendita e di ciascun Contratto è devoluta alla competenza esclusiva del Tribunale di Modena.
- 11.3 Resta inteso tra le Parti che soltanto il Venditore, a propria discrezione, ha la facoltà di rinunciare alla competenza del foro esclusivo di cui al precedente art.11.2 per agire in giudizio nei confronti dell'Acquirente al suo domicilio e presso il Tribunale ivi competente.
- 11.4 Al fine di interpretare i termini di resa e gli altri termini commerciali eventualmente utilizzati dalle Parti si rinvia agli Incoterms 2020 della Camera di Commercio Internazionale di Parigi e agli usi 2005 della Camera di Commercio di Modena per i materiali ceramici.

12. Marchi e segni distintivi del Venditore

- 12.1 L'Acquirente è tenuto ad usare i marchi, nomi o altri segni distintivi del Venditore, però al solo fine di identificare e pubblicizzare i Prodotti, essendo inteso che tale uso viene fatto nell'esclusivo interesse del Venditore. Tuttavia, qualsiasi uso dei marchi, nomi o altri segni distintivi del Venditore sulla carta intestata dell'Acquirente, sul materiale pubblicitario o su altro materiale comunque destinato a terzi dovrà essere concordato preventivamente per iscritto con il Venditore.
- 12.2 L'Acquirente impegna a non inserire i marchi, nomi e segni distintivi del Venditore nella propria ditta, denominazione sociale o domini web. In ogni caso, l'Acquirente si impegna a non registrare i marchi e/o i segni distintivi del Venditore inclusi i domini web.
- 12.3 Il diritto dell'Acquirente di usare i marchi, nomi o altri segni distintivi del Preponente, come previsto al precedente art. 12.1, cesserà immediatamente con la scadenza o la risoluzione, per qualsiasi causa, delle presenti Condizioni Generali di Vendita o di qualsiasi Contratto stipulato tra Acquirente e Venditore.
- 12.4 L'Acquirente informerà il Venditore di qualsiasi violazione dei marchi, nomi o altri segni distintivi del Venditore di cui venga a conoscenza.

13. Disposizioni Finali

- 13.1 L'invalidità in tutto o in parte di singole disposizioni delle presenti Condizioni Generali di Vendita non inficia la validità delle restanti previsioni.
- 13.2 Le presenti Condizioni Generali di Vendita possono essere modificate, integrate, variate esclusivamente da parte del Venditore e per iscritto.

1 General Provisions

- 1.1 In addition to the terms and expressions defined elsewhere in these General Terms of Sale, the terms and expressions listed below – starting with a capital letter – shall have the meaning conventionally ascribed to them or specified in this art. 1.1:
- "Buyer": refers to the natural or legal person from which the Seller receives the order;
 - "Contract": refers to the Buyer's purchase order accepted by the Seller, comprehensive of the General Terms of Sale;
 - "EXW": (also known as Ex Works – Franco Fabbrica) refers to the relevant rights and obligations of Buyer and Seller provided for in the Incoterm 2020 of the International Chamber of Commerce of Paris;
 - "Parties": refers to the Buyer and the Seller jointly;
 - "Products": refers to the products of the Seller resulting from the price list and sales catalogs year by year in force;
 - "Seller": refers to Emilceramica S.r.l. a socio unico, with registered office at Via Ghiarola Nuova, 29 - 41042 Fiorano Modenese (MO), Italy.
- 1.2 The terms and conditions set out below (the "General Terms of Sale") shall form part of any and all the agreements entered into between the Seller and the Buyer for the sale of the Products, and they shall prevail over every general terms of the Buyer, unless expressly accepted upon in writing by the Seller.
- 1.3 The Seller shall reserve the right to modify, supplement or amend the General Terms of Sale, by indication of such variations in the offers or any other written communication to the Buyer. If the Buyer does not accept the modifications, supplements or amendments of the General Terms of Sale within 15 days from the date of communication, the previous General Terms of Sale shall apply, without prejudice to the Seller's right to terminate the Contract entered into with the Buyer, if any, within 30 days thereafter.

2 Offers and Orders

- 2.1 The offer to the Buyer made and/or the order to the Seller sent by agents, brokers or other intermediaries shall not be binding upon the Seller until the order of the Buyer is accepted by the Seller according to art. 2.2 of the General Terms of Sale.
- 2.2 No order submitted by the Buyer shall be deemed to be accepted unless and until confirmed in writing by the Seller. If an order is not confirmed in writing by the Seller, the issuance by the Seller of the relevant invoice or the performance by the Seller shall be deemed to be an acceptance of the order.

3 Terms of Delivery

- 3.1 The delivery of the Products shall be EXW. The Seller shall deliver the Products by making them available to the Buyer according to the terms and at the place as specified in the Contract (the "Delivery"). Upon Delivery, the Seller shall only assume the obligation to load the Products on the load vehicle, any other obligation being excluded.
- 3.2 The Seller shall not be liable for any loss or damage to the Products after Delivery to the Buyer; under no circumstances shall the Buyer be released from its obligation to pay the price of the Products upon the Delivery.
- 3.3 Without prejudice to the remedies set forth under art. 9, if the Buyer does not fulfill the obligation to pay the price of the Products, the Seller shall be entitled to suspend the Delivery.
- 3.4 All the deadlines in connection with Products' delivery and return - although defined as mandatory - shall be considered as merely indicative, and binding on the Seller within the normal tolerance range. The Delivery terms - even though indicative - are only, and exclusively, those specified in the order confirmation of the Seller.
- 3.5 In case of delay in the Delivery that exceeds the normal tolerance, the Buyer may only cancel the part of the order relating to Products not delivered within 30 days following the date of receipt by the Seller of the cancellation notice of the Buyer to be sent through registered letter with return receipt.
- 3.6 The Buyer cannot cancel its order or withdraw from the Contract in case the Delivery is delayed due to the occurrence of events of force majeure referred to under art. 6 if the delay of the Delivery does not exceed 60 days.
- 3.7 In case of occurrence of events of force majeure referred to under art. 6, the Seller may terminate the Agreement by written notice to the Buyer.
- 3.8 In case the Delivery does not take place for any reason related to the Buyer, upon simple communication to the Buyer that the Products are at its disposal, the Delivery is considered performed for all purposes (including to the effect of the terms of payment and the issuance of the invoice). After 15 days from the communication warehouse, expenses are applied and the Seller is relieved from any responsibility for destruction, damage or loss of value of the Products.
- 3.9 In case of non-delivery of the Products at the place of destination indicated in the transport document, or in case the Products are delivered in a place other than that indicated in the transport document, the Buyer undertakes to inform the Seller within 120 hours after the scheduled date for delivery at the place of destination through registered letter with return receipt also containing the copy of the signed transport document. Following the receipt of the communication including the documentation, the Seller provides to the regularization of invoices issued charging VAT according to Italian Presidential Decree no. 600/1973. The Buyer shall indem-

nify the Seller for any taxes, surcharges, interest and penalties of any kind – as well as legal expenses - should any amounts be charged by tax authorities as a result of failure to provide such notification in writing or, however, the delivery of Products at the place of destination other than that indicated in the transport document. The Buyer, having acknowledged the notice that the Seller requires the carrier to sign, undertakes to communicate to the carrier any change or modification of the destination of the Products. In case the Buyer fails to comply with the aforementioned obligation, the Seller shall charge the Buyer for any taxes, surcharges, interest and penalties of any kind - as well as legal expenses - should any amounts be charged by tax authorities as a result of said failure.

3.10 Except in cases of willful misconduct or gross negligence, the Seller shall not be liable in any way for damages arising from late Delivery or non-Delivery (total or partial) of Products.

4 Prices and Terms of Payment

- 4.1 The prices of the Products indicated in the price list year by year are EXW; therefore, any other charges or expenses related to shipping, delivery and / or transport of the Products are the sole responsibility of the Buyer. The funding necessary to deal with any Buyer's charges and expenses is anticipated by the latter to the Seller; by way of example only, such expenses and charges comprise costs of additional packaging, shipping cost, accessories, tax charges, stamp duties, customs fees, and any additional charges not including the prices. The prices of the Products may be subject to corrections due to printing errors.
- 4.2 Prices of the Products are exclusive of VAT at the rate applicable by law, to be paid in accordance with the invoice.
- 4.3 The place of payment is at the registered office of the Seller even in the case of drafts, cash orders or bills. The acceptance by the Seller of payment in the form of bills, promissory notes, endorsed bills or bank cheques shall always be «subject to collection» and without scope for novation of the debt. Payment is due in full upon Delivery of the Products, unless otherwise agreed in writing.
- 4.4 In addition to other remedies provided by law and / or the Contract, the Seller shall apply default interest on late payments in accordance with the provisions of Legislative Decree. no.231 of 2002.

5 Terms of Warranty

- 5.1 The Seller warrants that the Products are free from defects and flaws for a period of 12 months from Delivery. The warranty operates within the limits of art. 1495 of the Italian Civil Code, subject to the additional restrictions provided for in this article and in the provincial collection of uses of 2005 foreseen by the Chamber of Commerce of Modena for the ceramics and the normal tolerances. Any indications of weights, measures, dimensions, colors, shades and other data contained in catalogs, brochures, folders, of the Seller are merely indicative and not binding. The warranty of the Seller is in any case limited to first choice Products - as indicated by the 2005 principles and rules set out by the Chamber of Commerce of Modena for ceramic products – i.e. with a percentage of defective tiles not exceeding 5%, for the part exceeding that percentage. The warranty does not operate for Products different from those of first choice. Except in cases of willful misconduct or gross negligence, the Buyer cannot claim differences in tone as vice of Products.
- 5.2 Pursuant to the warranty obligation of the Seller, the latter undertakes to replace the defective and / or damaged product within the limits of the Contract and without any further obligation of indemnification for direct and / or indirect and / or consequential damages caused by defective Products to the Buyer and / or third parties, save for the mandatory provisions of law. The Parties acknowledge and agree that the Seller's aggregate liability to the Buyer hereunder shall, in all cases, be limited to the amount of the price paid by the Buyer for the Products giving rise to the Supplier's liability.
- 5.3 The liability for defects and flaws no longer applies following the installation of the Products; any claims must be made before the installation through registered letter with return receipt to be addressed to the Seller, and must indicate in detail the vices and defects found. The complaint does not give the Buyer the right to suspend or delay, in whole or in part, the payment.
- 5.4 It is understood that the warranty referred to in this article is excluded from the installation as well as where the flaw and / or defect of the Products is caused by incorrect use, modification or alteration of the same Products attributable to the Buyer.

6 Force Majeure

- 6.1 The Seller may suspend the execution and / or withdraw from the Contract if performance is objectively impossible or excessively burdensome because of unforeseeable events beyond its control, such as, for example, strikes, labor disputes, accidents, explosions, boycott, lockout, fire, war, civil war, riots, revolutions, requisitions, embargo, energy, flood, acts or omissions of law or government, acts of terrorism, delay or failure to supply of its suppliers, equipment or essential equipment breakdowns, and other causes similar to those listed above.

7 Anti – Bribery. Code of Ethics

- 7.1 The Buyer shall comply with any law, regulation, directive and applicable law of any authority, governmental entity, and any other national and international institution relating to practices and offences of corruptive nature (the "Applicable Law"), including, rules concerning illegal payments or offers or promises of money or other benefits to public officials or persons in charge of public services for the performance of their duties or powers.
- 7.2 In particular, Buyer shall comply with the US Foreign Corrupt Practices Act, the Convention on Combating Bribery of Foreign Officials in International Business Transactions of 1997, and any other Applicable Law relating to bribery.
- 7.3 The Buyer shall, and shall procure that its officers, directors, employees, contractors or consultants shall, not undertake, directly or indirectly, any action in the performance of any Contract and supply provided for therein, which may constitute a breach of any Applicable Laws, and, in particular, the Buyer shall, and shall procure that its officers, directors, employees, contractors or consultants shall, not: a) offer, make or authorize any contribution, payment or gift or other benefits to public officials or persons in charge of public services officials, employees or agents of any authority, governmental entity, and any other national and international institution; (b) make any contribution, of any nature, to any candidate to a public office.
- 7.4 The Buyer shall comply with the provisions of Legislative Decree no. 231/2001, as subsequently amended and supplemented. For these purposes, the Buyer represents to have examined the Code of Ethics of the Seller (the "Code of Ethics"), and the Model of Organization, Management and Control pursuant to Legislative Decree no. 231/2001 (the "Model"). The Code of Ethics and the Model may be consulted on the following web site: <https://www.emilgroup.com/downloadarea/>
- The Seller undertakes to perform the supplies under the Contract in compliance with the rules provided under the Code of Ethics and the Model.
- 7.5 The Buyer shall, and shall procure that its officers, directors, employees, contractors or consultants which will be in contact with the Seller in the performance of the supplies under the Contract shall, promptly inform the Supervisory Body of the Seller of any act, fact or action of which it became aware, and may constitute a crime included in the scope of Legislative Decree no. 231/2001, and may imply the administrative liability of the Seller.
- 7.6 If during the execution of the Contract, the Buyer incurs in a conduct described in art. 2635 of the Italian Civil Code, the Seller has the right to terminate the Contract.
- 7.7 In case of breach of the Buyer of its undertakings under articles 7.3 and 7.5, the Seller has the right to terminate the Contract pursuant to art. 1456 of the Italian Civil Code.
- 7.8 The Buyer represents and warrants that it is not designated on, owned by or associated with, any party designated on any U.S., E.U. or other government restricted parties' lists, including without limitation, the U.S. Treasury Department Office of Foreign Assets Control's Specially Designated Nationals and Blocked Persons List, and the Buyer agrees that it will not sell or transfer any goods to such persons. The Buyer shall comply with all applicable U.S., E.U. or other applicable economic sanctions and export control laws and regulations, including without limitation, the regulations administered by the Office of Foreign Assets Control.
- 7.9 In case of breach of the Buyer of its undertakings, representations and warranties under art. 7.8, the Seller has the right to terminate the Contract pursuant to art. 1456 of the Italian Civil Code.

8 Personal Data Protection

- 8.1 For the purpose of executing the Contract, the Parties undertake to comply with all the obligations set out in the General Data Protection Regulation (UE) 2016/679 on "the protection of natural persons with regard to the processing of personal data and on the free movement of such data" (hereinafter "GDPR"), as well as, within the limits of its applicability, Italian Legislative Decree 196/2003 ("Privacy Code"), as most recently amended by Italian Legislative Decree 101/2018 and in the provisions of the Italian Data Protection Authority.
- 8.2 By signing this Contract, the Parties, each to the extent of its respective competence, acknowledge that their own personal data and/or of their employees and/or collaborators involved in the activities referred to the Contract, will be communicated to the other Party and processed by the latter as an autonomous Data Controller for purposes strictly functional to the setting up and execution of the Contract.
- 8.3 In particular, the Buyer acknowledges that the Seller will process his personal data and/or of its employees and/or collaborators, involved in the activities referred to the Contract, as autonomous Data Controller for the purposes and in accordance with the modalities specified in the information notice provided pursuant to Articles 13 and 14 of the GDPR available on the website www.emilgroup.com under Privacy, which the Buyer undertakes to bring to its employees' and/or collaborators' knowledge.

9 Termination of the Contract

- 9.1 The Seller has the right to terminate any Contract with the Buyer, with immediate effect, in accordance with art. 1456 of the Italian Civil Code, by notice sent through registered letter in the following cases:
- a) if the Buyer fails to fulfil its obligations under articles 3.9, 4 and 7 of these General Terms of Sale;
 - b) if the Buyer is in material breach of the Contract.

9.2 The Seller has the right to withdraw with immediate effect by each Contract by notice sent through registered letter to the Buyer in the following cases:

- a) the Buyer fails to fulfil its obligations under articles 1.3, 3.7, 6.1;
- b) the Buyer is subject to enforcement, insolvency or liquidation proceedings;
- c) the Buyer's economic and financial situation can be reasonably considered a situation of crisis;
- d) shares and / or quotas representing the majority or the Buyer's control of share capital - in case of corporate - are directly or indirectly sold, disposed of, or restricted in guarantee.

10 Retention of Title

10.1 The Seller shall retain title in the Products sold until it has received full payment of the agreed price from the Buyer. Consequently, the Buyer undertakes i) to make good use of them, according to their intended use; ii) not to transfer their title to third parties, unless expressly and previously authorized by the Seller. In the event that the Buyer fails to pay all or part of the Products by the due date, the Seller may retake possession of the Products delivered, at its simple request. Notwithstanding the above, the Buyer shall be liable for any damage and loss occurring to the Products after Delivery, even if caused by force majeure or other events not attributable to the Buyer.

11 Applicable Law – Competent Jurisdiction

- 11.1 These General Terms of Sale and each Contract entered in to by the Buyer with the Seller shall be governed by Italian law.
- 11.2 Any dispute arising between the Parties concerning the interpretation, validity or enforcement of these General Terms of Sale and any Contract shall be referred to the exclusive jurisdiction of the Court of Modena.
- 11.3 Only the Seller, at its discretion, has the right to waive the exclusive jurisdiction of the Court referred to in previous art.11.2 to take legal action against the Buyer at his residence and at the Court therein competent.
- 11.4 In order to interpret the terms of return of the Products and other commercial terms used by the Parties, reference is made to the Incoterms 2020 of the Chamber of Commerce of Paris and 2005 principles and rules set out by the Chamber of Commerce of Modena for ceramic products.

12 Seller's trademarks and distinctive signs

- 12.1 The Buyer is obliged to use the Seller's trademarks, names and other distinctive signs, but only for the purpose to identifying and advertising the Products, it being understood that such use is of the exclusive interest of the Principal. In all events, any use of the Seller's trademarks, names or other distinctive signs on the Buyer's headed paper, on advertising material or on any other material however intended for third parties, must be agreed to beforehand in writing with the Seller.
- 12.2 The Buyer undertakes not to insert the Seller's trademarks, names and distinctive signs in their firm or company name as well as web sites. The Buyer shall not register the Seller's trademarks and/or distinctive signs, including web domain names.
- 12.3 The Buyer's right to use the Seller's trademarks, names or other distinctive signs, as provided for in article 12.1 above, shall immediately terminate with the expiry or termination, for whatever reason, of this General Terms of Sale or any Contracts entered in to between the seller and the Buyer.
- 12.4 The Buyer shall inform the Seller of any violation of its trademarks, names or other distinctive signs of which they become aware.

13 Final Provisions

- 13.1 The invalidity in whole or in part of any provision of these General Terms of Sale shall not affect the validity of the remaining provisions.
- 13.2 These General Terms of Sale may be amended, supplemented, varied, only in writing by the Seller.

EMILCERAMICA

CONDITIONS GENERALES DE VENTE A L'EXPORTATION ET DE GARANTIE

1. Dispositions Générales

1.1 En plus des termes et locutions définis autre part dans ces Conditions Générales de Vente (définies par la suite), les termes et locutions énumérés ci-après ont – lorsqu’ils sont indiqués avec une lettre majuscule – le sens qui leur est attribué conventionnellement ou qui est rappelé dans le présent art. 1.1 :

- « Acquéreur » : la personne, physique ou morale, de laquelle le Vendeur (défini par la suite) reçoit la commande ;

- « Contrat » : la commande de l’Acquéreur, acceptée par le Vendeur, comprenant les Conditions Générales de Vente (définies par la suite) ;

- « EXW » : la réglementation des droits et obligations de l’Acquéreur et du Vendeur (définie par la suite) prévue, en référence à l’acronyme de Ex Works (Départ Usine), par les Incoterms 2020 de la Chambre de Commerce Internationale de Paris ;

- « Parties » : l’Acquéreur et le Vendeur conjointement ;

- « Produits » : les produits du Vendeur qui figurent sur les tarifs et les catalogues annuels en vigueur ;

- « Vendeur » : Emilceramica S.r.l. a socio unico, dont le siège social est sis Via Ghiarola Nuova, 29 – 41042 Fiorano Modenese (Modène), Italie.

1.2 Les termes et conditions indiqués ci-après (les « Conditions Générales de Vente ») font partie intégrante de chaque Contrat signé entre le Vendeur et l’Acquéreur dans le cadre de la vente des Produits et prévalent sur d’éventuelles conditions fixées par l’Acquéreur, sauf en présence d’une acceptation écrite expresse de ces dernières par le Vendeur.

1.3 Le Vendeur se réserve le droit de modifier ou compléter les Conditions Générales de Vente, en annexant ces modifications aux offres ou à toute communication écrite adressée à l’Acquéreur. Au cas où les modifications ou compléments apportés aux Conditions Générales de Vente ne seraient pas acceptés par l’Acquéreur dans les 15 jours suivant la date de communication, les Conditions Générales de Vente acceptées précédemment seront appliquées, sans préjudice du droit de retrait du Vendeur dans les 30 jours suivants.

2. Offres et Commandes

2.1 L’offre faite à l’Acquéreur par des agents, démarcheurs ou par d’autres intermédiaires et la proposition de commande transmise par ces derniers au Vendeur n’engage pas celui-ci tant que la commande de l’Acquéreur n’a pas été acceptée par le Vendeur au sens de l’art. 2.2 suivant.

2.2 La commande effectuée par l’Acquéreur n’est pas acceptée tant qu’elle n’a pas été confirmée par écrit par le Vendeur. Au cas où le Vendeur ne confirmerait pas une commande par écrit, l’émission de la facture ou l’exécution de la commande par le Vendeur doit être considérée comme une acceptation.

3. Délais de Livraison

3.1 La livraison des Produits est EXW. Le Vendeur effectue la livraison en mettant les Produits à la disposition de l’Acquéreur dans les délais et aux lieux précisés dans le Contrat (la « Livraison »). Au moment de la Livraison, le Vendeur a pour seule obligation de charger les Produits sur le véhicule de prise en charge, toute autre obligation restant exolue.

3.2 Le Vendeur n’est responsable d’aucune perte ou endommagement des Produits après la Livraison ; l’Acquéreur n’est en aucun cas déchargé de l’obligation de paiement du prix des Produits une fois la Livraison effectuée.

3.3 Sans préjudice des mesures correctives visées à l’art. 9 suivant, la Livraison peut être suspendue dans tous les cas de défaillance de l’Acquéreur concernant l’obligation de paiement du prix des Produits.

3.4 Tous les délais de livraison et de retour des Produits - même s’ils sont définis comme péremptaires - sont considérés comme indicatifs et assumés par le Vendeur avec toutes les tolérances d’usage. Le délai de Livraison - dans tous les cas indicatif - est uniquement celui indiqué dans la confirmation de commande du Vendeur.

3.5 En cas de retard de Livraison dépassant la tolérance d’usage, l’Acquéreur peut uniquement annuler la partie de la commande relative aux Produits dont la Livraison n’a pas lieu dans les 30 jours suivant la date de réception par le Vendeur de la communication d’annulation de l’Acquéreur, à envoyer par lettre recommandée avec accusé de réception ou PEC (Courrier électronique certifié).

3.6 L’Acquéreur ne peut annuler sa commande, ni résilier le Contrat, en cas de Livraison retardée dépendant d’un cas de force majeure, conformément à l’art. 6 suivant, si le retard de Livraison ne dépasse pas 60 jours.

3.7 Le Vendeur peut résilier le Contrat en envoyant une communication écrite à l’Acquéreur en cas d’événements de force majeure, conformément à l’art. 6 suivant.

3.8 Si la Livraison n’a pas lieu pour un motif imputable à l’Acquéreur, celle-ci est considérée comme effectuée, à tous les effets (y compris l’entrée en vigueur des délais de paiement et l’émission de la facture), par simple communication à l’Acquéreur de mise à disposition des Produits ; 15 jours après la communication, des frais d’entreposage sont appliqués et le Vendeur est déchargé de toute responsabilité en cas de détérioration, endommagement ou quoi qu’il en soit perte de valeur des Produits.

3.9 L’Acquéreur s’engage à communiquer au Vendeur la non-livraison des Produits au lieu de destination indiqué sur le document de transport ou bien la livraison des Produits dans un autre lieu que celui indiqué sur le document de transport dans les 120 heures suivant la date de livraison prévue au lieu de destination, par lettre recommandée avec accusé de réception ou PEC (Courrier électronique certifié), contenant également une copie du document de transport signé. Suite à la réception de ladite communication

accompagnée de la documentation, le Vendeur procède à la régularisation des factures émises avec application de la TVA au sens du DPR (décret présidentiel italien) n° 600/1973. Il reste entendu que l’Acquéreur s’engage à exonérer le Vendeur des impôts, surtaxes, intérêts et sanctions en tout genre, ainsi que des frais de justice, en cas de prélèvements effectués par l’Administration Financière à sa charge dérivant de la non-communication par écrit ou dans tous les cas de la livraison des Produits à une autre destination que celle indiquée dans le document de transport. Après avoir pris note de la communication que le Vendeur demande de signer au transporteur, l’Acquéreur s’engage également à communiquer au transporteur toute modification de destination des Produits. Le non-respect de la précédente obligation comporte le prélèvement par le Vendeur à l’Acquéreur d’éventuels impôts, surtaxes, intérêts et sanctions en tout genre, ainsi que des charges de nature juridique, en cas de relevés de l’Administration Financière dérivant de cette non-communication.

3.10 Sans préjudice des cas de dol ou faute grave, toute responsabilité du Vendeur en cas de dommages dérivant d’une livraison (totale ou partielle) retardée ou non effectuée des Produits est exclue.

4. Prix et Conditions de Paiement

4.1 Les prix des Produits indiqués sur les tarifs annuels s’entendent EXW ; par conséquent, toute autre charge ou dépense relative à l’expédition, la livraison et/ou le transport des Produits est à la charge exclusive de l’Acquéreur. La provision nécessaire pour faire face à d’éventuelles charges et dépenses à la charge de l’Acquéreur devra, le cas échéant, être payée par celui-ci au Vendeur par avance ; à titre d’exemple, ces charges et dépenses comprennent le coût de l’emballage supplémentaire, le coût du transport, les frais accessoires, les impôts, timbres, frais de douane et toute autre charge supplémentaire non comprise dans les prix. Les prix des Produits peuvent être soumis à des corrections en raison d’erreurs d’impression.

4.2 Les prix des Produits sont hors taxe, la TVA légale devant être versée conformément aux indications de la facture.

4.3 Le lieu de paiement est établi au siège social du Vendeur même en cas d’émission de traites ou reçus bancaires, ou bien de remise de lettres de change. L’éventuelle acceptation de traites, billets à ordre, cessions ou chèques bancaires par le Vendeur est toujours convenue sauf bonne fin et/ou avec recours et sans novation de la dette. Le paiement est entièrement dû au moment de la Livraison des Produits, sauf en présence d’un accord écrit différent.

4.4 Outre les autres remèdes prévus par la loi et/ou par le Contrat, le Vendeur applique des intérêts de retard sur les paiements retardés conformément aux dispositions du décret législatif italien n° 231 de 2002.

5. Conditions de Garantie

5.1 Le Vendeur garantit que les Produits sont exempts de tout vice et défaut pendant une durée de 12 mois à compter de la livraison. La garantie s’applique dans les limites visées à l’art. 1495 du Code Civil italien, sans préjudice des autres limitations mentionnées dans le présent article et la collecte provinciale des usages 2005 de la Chambre de Commerce de Modène pour les matériaux céramiques, ainsi que les tolérances d’usage. Les éventuelles indications de poids, mesures, dimensions, couleurs, nuances et autres informations contenues dans les catalogues, dépliants et dossiers du Vendeur ont un caractère purement indicatif et ne sont pas contraignantes. La garantie du Vendeur est dans tous les cas limitée aux Produits de premier choix, à savoir-selon les indications de la collecte provinciale des usages 2005 de la Chambre de Commerce de Modène pour les matériaux céramiques - avec un pourcentage de carreaux défectueux non supérieur à 5 %, seulement pour la partie dépassant ce pourcentage, tandis que la garantie est expressément exclue pour les Produits autres que ceux de premier choix. Sans préjudice des cas de dol ou faute grave, les différences de nuances par rapport à ce qui a éventuellement été convenu ne peuvent être dénoncées comme vice des Produits.

5.2 Avec l’obligation de garantie, le Vendeur s’engage à remplacer le produit vicié et/ou défectueux dans les limites du Contrat et quoi qu’il en soit sans aucune autre obligation d’indemnisation du dommage direct et/ou indirect et/ou consécutif provoqué à l’Acquéreur et/ou à des tiers en raison de défauts des Produits, sans préjudice des dispositions légales obligatoires. En tout état de cause, les Parties reconnaissent que la responsabilité totale du Vendeur envers l’Acquéreur est limitée au prix payé par l’Acquéreur pour les Produits donnant lieu à la responsabilité du Vendeur.

5.3 Dans tous les cas, la garantie pour les vices et les défauts prend fin lors de la pose en œuvre des Produits ; par conséquent, les réclamations doivent être effectuées avant la pose en œuvre par lettre recommandée avec accusé de réception ou PEC (Courrier électronique certifié). à adresser au Vendeur, et elles doivent documenter de façon détaillée les vices et défauts constatés. La réclamation ne donne à l’Acquéreur aucun droit de suspension ou de retard, total ou partiel, du paiement dans les délais établis par le Contrat.

5.4 Il reste entendu que la garantie mentionnée dans le présent article est exclue de la pose en œuvre ainsi que si le vice et/ou le défaut des Produits dépendent de l’usage incorrect, de la modification ou de l’altération desdits Produits, imputables à l’Acquéreur.

6. Cas de force majeure

6.1 Le Vendeur peut suspendre l’exécution du Contrat et/ou le résilier dès lors que son exécution s’avère objectivement impossible ou excessivement onéreuse en raison d’un événement imprévisible indépendant de sa volonté comme, par exemple, grève, litige syndical, accident, explosion, boycottage, grève patronale, incendie, guerre, guerre civile, émeute et révolution, épidémie, réquisition, embargo, interruption de fourniture d’énergie, inondation, acte ou omission de loi ou de gouvernement, acte de terrorisme, retard ou impossibilité d’approvisionnement de ses fournisseurs, pannes de machines ou d’équipements essentiels et autres causes analogues à celles susmentionnées.

7. Anti-corruption. Code Éthique

7.1 L’Acquéreur respecte les dispositions des lois, règlements et directives applicables de toutes les autorités, les organismes gouvernementaux ou autres institutions nationales ou internationales à propos de pratiques et de faits illicites ayant trait à la corruption (la « Loi Applicable »), y compris les lois concernant des paiements illicites, offres, promesses d’argent ou tout autre bénéfice en faveur d’officiers publics ou de personnes chargées d’un service public pour accomplir leurs fonctions ou pouvoirs.

7.2 Plus précisément, l’Acquéreur respecte les dispositions du U.S. Foreign Corrupt Practices Act, de la Convention on Combating Bribery of Foreign Officials in International Business Transactions de 1997 et toute autre Loi Applicable en matière de corruption.

7.3 L’Acquéreur s’engage, pour lui-même et pour ses propres fonctionnaires, administrateurs, travailleurs, collaborateurs ou consultants, à ce que ne soit accomplie, ni directement ni indirectement, aucune action dans le cadre de l’exécution d’un contrat pouvant constituer un fait illicite comme le prévoit n’importe quelle Loi Applicable, et il s’engage en particulier, pour lui-même et pour ses propres fonctionnaires, administrateurs, travailleurs, collaborateurs ou consultants, à ce que ne soient offerts, donnés ou autorisés a) aucune dation ni paiement, gratification ou tout autre bénéfice à des fonctionnaires ou personnes chargées de la fonction publique, employés ou agents de toute autorité, organisme gouvernemental, et de toute autre institution nationale et internationale ; b) aucune contribution, de n’importe quelle nature, à quiconque étant candidat à l’exercice d’une charge publique.

7.4 L’Acquéreur respecte les dispositions du Décret législatif italien 231/2001, modifié et intégré. Dans ce but, l’Acquéreur déclare connaître le Code Éthique du Vendeur (le « Code Éthique ») et le Modèle d’organisation, gestion et contrôle prévu par le Décret législatif italien 231/2001 (le « Modèle »). Le Code Éthique et le Modèle peuvent être consultés à l’adresse suivante : <https://www.emilgroup.it/downloadarea/>. Le Vendeur s’engage à prendre les commandes conformément aux dispositions de ces Conditions Générales de Vente, au Code Éthique et au Modèle.

7.5 L’Acquéreur s’engage, pour lui-même et pour ses propres fonctionnaires, administrateurs, travailleurs, collaborateurs ou consultants qui entrent en contact avec le Vendeur dans le cadre de l’exécution des Contrats, à ce que le responsable du Vendeur soit informé de tout acte, fait ou action dont ils peuvent avoir connaissance et pouvant constituer une infraction au sens du décret législatif italien 231/2001 ou pouvant, dans tous les cas, impliquer la responsabilité administrative du Vendeur au sens de cette loi.

7.6 Durant l’exécution du Contrat, si l’Acquéreur adopte une des conduites décrites à l’art. 2635 du Code Civil italien, le Vendeur a le droit de résilier le Contrat, au sens de l’art. 1456 du Code Civil italien.

7.7 En cas de violation de la part de l’Acquéreur de certaines des obligations visées aux articles 7.3 et 7.5, le Vendeur a le droit de résilier le Contrat, au sens de l’art. 1456 du Code Civil italien.

7.8 L’Acquéreur déclare et garantit qu’il n’a pas été désigné, qu’il n’est ni contrôlé par ou associé avec un quelconque des acteurs inclus dans les listes de restriction des États-Unis, de l’Union Européenne ou de tout autre pays, y compris, sans limitation aucune, le U.S. Treasury Department Office of Foreign Assets Control’s Specially Designated Nationals and Blocked Persons List ; et l’Acquéreur s’engage à ne vendre ou transférer aucun Produit auxdits acteurs à un autre titre. L’Acquéreur déclare respecter les dispositions relatives aux sanctions économiques, ainsi qu’aux lois, règlements de contrôle sur l’exportation en vigueur aux États-Unis, au sein de l’Union Européenne et dans tout autre pays, y compris, sans limitation aucune, les règlements de l’Office of Foreign Assets Control.

7.9 En cas de violation de la part de l’Acquéreur de certaines des obligations, déclarations et garanties visées au précédent article 7.8, le Vendeur a le droit de résilier le Contrat, au sens de l’art. 1456 du Code Civil italien.

8. Protection des données à caractère personnel

8.1 Aux fins de l’exécution du Contrat, les Parties s’engagent à se conformer à toute obligation prévue par le Règlement Général (UE) 2016/679 relatif à la « protection des personnes physiques à l’égard du traitement des données à caractère personnel et à la libre circulation de ces données » (ci-après « RGPD »), ainsi que, dans les limites de son applicabilité, au Décret Législatif italien 196/2003 (« Code de Confidentialité »), sur la base de la dernière version modifiée par le Décret Législatif italien 101/2018 et aux mesures du Garant pour la protection des données à caractère personnel.

8.2 En acceptant ce Contrat, chaque Partie, pour ce qui la concerne, reconnaît que ses propres données à caractère personnel et/ou celles de ses employés et/ou collaborateurs, impliqués dans les activités d’exécution du Contrat, pourront être communiquées à la contrepartie et traitées par cette dernière en tant que Responsable autonome du traitement à des fins étroitement liées à l’établissement et à l’exécution du Contrat.

8.3 En particulier, l’Acquéreur reconnaît que ses propres données à caractère personnel et/

ou celles de ses employés et/ou collaborateurs, impliqués dans les activités du Contrat, seront traitées par le Vendeur en tant que Responsable autonome du traitement pour les objectifs et selon les modalités mentionnés dans la « Note d’information Clients » rédigée au sens des art. 13 et 14 du RGPD disponible sur le site web www.emilgroup.fr sous la section Privacy, que l’Acquéreur s’engage d’ores et déjà à porter à l’attention de ses employés et/ou collaborateurs.

9. Cessation du Contrat

9.1 Le Vendeur a le droit de résilier tout Contrat avec l’Acquéreur, avec effet immédiat, au sens de l’art. 1456 du Code Civil italien, par communication envoyée par lettre recommandée dans laquelle il déclare vouloir se prévaloir de cette clause résolutoire expresse, dans les cas suivants :

a) si l’Acquéreur ne se conforme pas aux obligations visées aux articles 3.9, 4 et 7 de ces Conditions Générales de Vente ;

b) si l’Acquéreur est responsable d’une grave inexécution du contrat.

9.2 Le Vendeur a le droit de résilier tout Contrat avec effet immédiat par communication envoyée par lettre recommandée à l’Acquéreur, dans laquelle il déclare vouloir se prévaloir de cette clause :

a) dans les cas visés aux articles 1.3, 3.7, 6.1.

b) si l’Acquéreur est soumis à des procédures de recouvrement forcé, d’insolvabilité ou de liquidation ;

c) si les conditions patrimoniales, économiques et financières de l’Acquéreur permettent de présumer raisonnablement de l’état de crise de l’Acquéreur ;

d) si les actions et/ou la part représentative de la majorité ou du contrôle du capital social de l’Acquéreur, s’il est constitué sous forme d’entreprise, sont directement ou indirectement cédées, aliénées ou liées à une garantie.

10. Réserve de Propriété

Le Vendeur conserve la propriété des Produits jusqu’au paiement intégral du prix convenu. Dès lors, l’Acquéreur s’oblige à i) en faire bon usage, conformément à leur destination ; ii) ne pas transférer la propriété et l’utilisation des Produits à des tiers, sauf autorisation préalable expresse du Vendeur. En cas de non-paiement par l’Acquéreur de tout ou partie des fournitures dans le délai prévu, le Vendeur est en droit de reprendre possession des produits livrés, et ce sur simple demande de sa part. Nonobstant ce qui précède, l’Acquéreur est responsable de tout dommage et de toute perte survenant après la livraison, même s’ils sont causés par des cas fortuits, des cas de force majeure ou d’autres événements non imputables à l’Acquéreur.

11. Loi Applicable – Tribunal Compétent

11.1 Ces Conditions Générales de Vente et tout Contrat souscrit par l’Acquéreur et le Vendeur sont réglémentés par la loi italienne.

11.2 Tout litige éventuel entre les Parties portant sur l’interprétation, la validité ou l’exécution de ces Conditions Générales de Vente et de tout Contrat est du ressort exclusif du Tribunal de Modène.

11.3 Les Parties conviennent que seul le Vendeur, à sa discrétion, a la faculté de renoncer à la compétence du tribunal exclusif mentionné au précédent art. 11.2 pour intenter une action en justice contre l’Acquéreur à son domicile et auprès du Tribunal compétent.

11.4 Afin d’interpréter les termes de retour et les autres termes commerciaux éventuellement employés par les Parties, il est fait renvoi aux Incoterms 2020 de la Chambre de Commerce Internationale de Paris et aux utilisations 2005 de la Chambre de commerce de Modène pour les matériaux céramiques.

12. Marques et signes distinctifs du Vendeur

12.1 L’Acquéreur est tenu d’utiliser les marques, noms ou autres signes distinctifs du Vendeur dans le seul but d’identifier ou de faire la publicité des Produits, sachant que cet usage est fait dans l’intérêt exclusif du Vendeur. Toutefois, tout usage des marques, noms ou autres signes distinctifs du Vendeur sur le papier à en-tête de l’Acquéreur, sur le matériel publicitaire ou sur tout autre matériel destiné à des tiers devra être convenu au préalable par écrit avec le Vendeur.

12.2 L’Acquéreur s’engage à ne pas insérer les marques, noms et signes distinctifs du Vendeur dans sa propre entreprise, raison sociale ou noms de domaine web. Dans tous les cas, l’Acquéreur s’engage à ne pas enregistrer les marques et/ou les signes distinctifs du Vendeur y compris les noms de domaine Web.

12.3 Le droit de l’Acquéreur d’utiliser les marques, noms ou autres signes distinctifs du Mandant, comme le prévoit le précédent art. 12.1, cessera immédiatement à l’échéance ou à la résiliation, pour n’importe quelle cause, de ces Conditions Générales de Vente ou de tout Contrat souscrit par l’Acquéreur et le Vendeur.

12.4 L’Acquéreur informera le Vendeur de toute violation des marques, noms ou autres signes distinctifs du Vendeur dont il est informé.

13. Dispositions Finales

13.1 L’invalidité totale ou partielle de chaque disposition de ces Conditions Générales de Vente n’affecte en rien la validité des prévisions restantes.

13.2 Ces Conditions Générales de Vente peuvent être modifiées et complétées uniquement par le Vendeur et par écrit.

EMILCERAMICA

ALLGEMEINE VERKAUFS - UND GARANTIEBEDINGUNGEN

1. Allgemeines

1.1 Zusätzlich zu den Begriffen und Termini, die in den Allgemeinen Geschäftsbedingungen an anderer Stelle (siehe weiter unten) definiert werden, haben die nachstehend angeführten Begriffe und Ausdrücke - wenn an ihrem Wortanfang ein Großbuchstabe steht - die Bedeutung, die ihnen im vorliegenden Art. 11 zugewiesen wird:

- „Käufer“: natürliche oder juristische Person, von welcher der Verkäufer (siehe weiter unten) den Auftrag erhält;

- „Vertrag“: vom Verkäufer angenommener Auftrag des Käufers einschließlich der Allgemeinen Geschäftsbedingungen (siehe weiter unten);

- „EXW“: Regelung der Rechten und Pflichten von Käufer und Verkäufer (siehe weiter unten) gemäß der Klausel Ex Works (ab Werk) aus den Incoterms 2020 der Internationalen Handelskammer (International Chamber of Commerce, ICC) mit Sitz in Paris;

- „Vertragsparteien“: Käufer und Verkäufer gemeinsam;

- „Produkte“: die Produkte des Verkäufers aus den im jeweiligen Jahr geltenden Preislisten und Katalogen;

- „Verkäufer“: Emilceramica S.r.l. a socio unico, Rechtssitz Via Ghiarola Nuova, 29 – 41042 Fiorano Modenese (Modena), Italien.

1.2 Die nachstehenden Bedingungen und Konditionen („Allgemeine Geschäftsbedingungen“) bilden einen integrierenden und wesentlichen Bestandteil jedes Vertrages, der zwischen dem Verkäufer und Käufer für den Kauf der Produkte abgeschlossen wird, und haben gegenüber etwaigen Bedingungen des Käufers Vorrang, sofern diese nicht ausdrücklich und in Schriftform vom Verkäufer akzeptiert wurden.

1.3 Der Verkäufer behält sich das Recht vor, die Allgemeinen Geschäftsbedingungen zu überarbeiten, zu ergänzen oder zu ändern und diese Änderungen den Angeboten bzw. jeglicher schriftlichen Mitteilung an den Käufer beizulegen. Werden die Überarbeitungen, Ergänzungen oder Änderungen der Allgemeinen Geschäftsbedingungen nicht vom Käufer binnen 15 Tagen ab dem Datum der Benachrichtigung akzeptiert, dann gelten die zuvor akzeptierten Allgemeinen Geschäftsbedingungen vorbehaltlich des Rücktrittsrechts des Verkäufers innerhalb der darauffolgenden 30 Tage.

2. Angebote und Aufträge

2.1 Das dem Käufer von Handelsvertretern, Geschäftsvermittlern oder anderweitigen Mittlern unterbreitete Angebot und das von diesen an den Verkäufer übermittelte Vertragsangebot, wird für den Verkäufer erst dann verbindlich, wenn er den Auftrag des Käufers gemäß nachfolgendem Art. 2.2 annimmt.

2.2 Der Auftrag des Käufers gilt erst nach schriftlicher Auftragsbestätigung des Verkäufers als angenommen. In Ermangelung der schriftlichen Auftragsbestätigung des Verkäufers gilt die Rechnungsausstellung bzw. die Auftragsabwicklung durch den Verkäufer als Annahme.

3. Lieferung

3.1 Die Lieferung der Produkte ist EXW. Der Verkäufer führt die Lieferung aus, indem er die Produkte dem Käufer innerhalb der Lieferfristen und an den Lieferorten, die im Vertrag angegeben sind, bereitstellt („Lieferung“). Bei der Lieferung obliegt dem Verkäufer ausschließlich die Verladung der Produkte auf das Abhoffahrzeug. Alle weiteren damit verbundenen Verpflichtungen sind ausgeschlossen.

3.2 Der Verkäufer haftet nach der Lieferung nicht bei Verlust oder Beschädigung von Produkten. Der Käufer ist nach erfolgter Lieferung unter keinen Umständen von der Pflicht zur Zahlung des Produktpreises befreit.

3.3 Vorbehaltlich der Maßnahmen gemäß Art. 9 kann die Lieferung in allen Fällen ausgesetzt werden, in denen der Käufer nicht seiner Pflicht zur Zahlung des Produktpreises nachkommt.

3.4 Alle Fristen für die Produktlieferung und -rückgabe - auch wenn sie verbindlich festgelegt sind - gelten als Richtangaben und werden vom Verkäufer mit den üblichen Toleranzen zur Anwendung gebracht. Die - in jedem Fall als Richtwert geltende - Lieferfrist ist einzig und allein in der Auftragsbestätigung des Verkäufers angegeben.

3.5 Überschreitet der Lieferverzug die übliche Toleranz, kann der Käufer den Auftrag nur teilweise bezüglich der Produkte stornieren, die nicht innerhalb von 30 Tagen ab dem Eingangsdatum der Stornierungsmittelung des Käufers per Einschreiben mit Rückschein oder per zertifizierter elektronischer Post (PEC) beim Verkäufer geliefert werden.

3.6 Der Käufer kann seinen eigenen Auftrag weder stornieren noch vom Kaufvertrag zurücktreten, wenn der Lieferverzug auf höhere Gewalt gemäß Art. 6 zurückzuführen ist und sofern der Lieferverzug in diesem Fall nicht mehr als 60 Tage beträgt.

3.7 Der Verkäufer kann vom Vertrag per schriftliche Benachrichtigung an den Käufer im Fall von höherer Gewalt gemäß Art. 6 weiter unten zurücktreten.

3.8 Ist der Lieferausfall vom Käufer verschuldet, dann gilt die Lieferung in jeder Hinsicht (einschließlich der Fälligkeit der Zahlungs- und Rechnungsfristen) durch einfache Benachrichtigung an den Käufer über die Bereitstellung der Produkte als ausgeführt. Nach Ablauf von 15 Tagen ab der Benachrichtigung fallen Lagerkosten an und ist der Verkäufer jeglicher Haftung für die Qualitätsminderung, Beschädigung oder den Wertverlust der Produkte entbunden.

3.9 Der Käufer verpflichtet sich, den Verkäufer über den Lieferausfall der Produkte am im Frachtbrief angegebenen Lieferort innerhalb von 120 Stunden nach dem vorgesehenen Liefertermin am Lieferort per Einschreiben mit Rückschein oder per zertifizierter elektronischer Post (PEC) zu unterrichten, wobei auch eine unterzeichnete Kopie des Frachtbriefs mitzusenden ist. Nach Empfang des vorgenannten Einschreibens einschließlich Unterlagen übernimmt der Verkäufer die Korrektur der ausgestellten Rechnungen unter Beaufschlagung der MwSt. gemäß ital. Dekret des Präsidenten der Republik Nr. 600/1973. Es

wird vereinbart, dass der Käufer den Verkäufer von Steuern, Gebührenzuschlägen, Zinsen und Bußgeldern jeglicher Art sowie Rechtskosten im Fall von Anrechnungen des Fiskus zu seinen Lasten schadlos hält, die sich mangels dieser schriftlichen Benachrichtigung oder infolge der Lieferung der Produkte an einem Lieferort in Abweichung von dem im Frachtbrief angegebenen Lieferort ergeben sollten. Der Käufer verpflichtet sich nach Kenntnisnahme der Benachrichtigung, deren Unterzeichnung der Verkäufer vom Spediteur verlangt, dem Spediteur jeden Wechsel oder jede Änderung des Lieferortes der Produkte mitzuteilen. Bei Nichterfüllung dieser Pflicht berechnet der Verkäufer dem Käufer etwaige Steuern, Gebührenzuschläge, Zinsen und Bußgelder jeglicher Art sowie Rechtskosten im Fall von Beanstandungen des Fiskus, die sich in Ermangelung dieser Benachrichtigung ergeben.

3.10 Vorbehaltlich der Fälle von vorsätzlicher Verschuldung oder schwerer Schuld ist jegliche Haftung des Verkäufers für Schäden infolge des (vollständigen oder teilweisen) Lieferverzugs oder Lieferausfalls der Produkte ausgeschlossen.

4. Preise und Zahlung

4.1 Die von Jahr zu Jahr in den Preislisten ausgewiesenen Produktpreise sind als Preise ab Werk (EXW) zu verstehen. Daraus folgt, dass alle weiteren Kosten oder Aufwendungen in Verbindung mit Versand, Lieferung und/oder Fracht ausschließlich der Käufer trägt. Etwaige Kosten und Aufwendungen zu Lasten des Käufers müssen bei Bedarf von diesem an den Verkäufer vorgestreckt werden. Die Kosten und Aufwendungen können, zu Beispielzwecken und ohne Anspruch auf Vollständigkeit, Verpackungsmehrkosten, Frachtkosten, Zusatzaufwendungen, Steuern, Stempelgebühren, Zollgebühren und alle weiteren zusätzlichen, nicht im Preis inbegriffenen Kosten umfassen. Die Produktpreise können wegen Druckfehlern Berichtigungen unterliegen.

4.2 Die Produktpreise verstehen sich netto zuzüglich der gesetzlich geltenden Mehrwertsteuer, die wie in der Rechnung ausgewiesen zu entrichten ist.

4.3 Als Zahlungsort gilt der Rechtssitz des Verkäufers, auch bei Buchung von Tratten oder Bankquittungen bzw. bei Hingabe von Wechseln. Die etwaige Annahme von Wechseln, Eigenwechseln, Indossamenten oder Bankschecks gilt nur unter Vorbehalt der Einlösung und/oder pro solvendo und bewirkt keine Schuldumwandlung (Novation). Vorbehaltlich anderslautender schriftlicher Vereinbarungen ist die Zahlung vollständig bei Auslieferung der Produkte fällig.

4.4 Zusätzlich zu anderen gesetzlich und/oder vertraglich vorgesehenen Mitteln berechnet der Verkäufer bei Zahlungsverzug Verzugszinsen gemäß ital. gesetzestretende Rechtsverordnung Nr. 231 von 2002.

5. Gewährleistung

5.1 Der Verkäufer gewährleistet für einen Zeitraum von 12 Monaten ab Lieferung, dass die Produkte frei von Fehlern und Mängeln sind. Die Gewährleistung gilt im Rahmen von Art. 1495 ital. ZGB vorbehaltlich weiterer Einschränkungen aus diesem Artikel und der Sammlng der in der Provinz geltenden Gebräuche der Handelskammer Modena von 2005 für keramische Materialien sowie der üblichen Toleranzen. Etwaige Angaben von Gewichten, Maßen, Abmessungen, Farben, Farbtönen und weitere Angaben in Katalogen, Broschüren und Prospekten des Verkäufers sind lediglich Richtangaben und unverbindlich. Die Gewährleistung des Verkäufers ist in jedem Fall auf die Produkte 1. Wahl - gemäß der Sammlung der in der Provinz geltenden Gebräuche der Handelskammer Modena von 2005 für keramische Materialien - mit einem Anteil von mangelhaften Fliesen von maximal 5 % begrenzt, und zwar nur für den diesen Prozentsatz übersteigenden Anteil. Die Gewährleistung gilt hingegen ausdrücklich nicht für alle weiteren Produkte, die nicht 1. Wahl sind. Vorbehaltlich der Fälle von vorsätzlicher Verschuldung oder schwerer Schuld können Abweichungen von den vereinbarten Farbtönen nicht als Produktmängel angezeigt werden.

5.2 Mit der Gewährleistung verpflichtet sich der Verkäufer, das fehler- oder mangelhafte Produkt im Rahmen der vertraglichen Bestimmungen zu ersetzen. Vorbehaltlich unabdingbarer gesetzlicher Bestimmungen hat er keine weiteren Ersatzpflichten für direkte und/oder indirekte Schäden und/oder Folgeschäden, die dem Käufer und/oder Dritten aus Produktmängeln entstehen sollten. In jedem Fall wird von den Vertragsparteien hiermit anerkannt, dass sich die Gesamthaftung des Verkäufers gegenüber dem Käufer auf den vom Käufer geleisteten Kaufpreis derjenigen Produkte beschränkt, die Gegenstand der Gewährleistung des Käufers bilden.

5.3 Die Gewährleistung für Fehler und Mängel verfällt in jedem Fall mit der Verlegung der Produkte. Beanstandungen müssen dem Verkäufer daher vor Verlegung per Einschreiben mit Rückschein oder per zertifizierter elektronischer Post (PEC) angezeigt werden, wobei die festgestellten Fehler und Mängel ausführlich zu dokumentieren sind. Die Beanstandung berechtigt den Käufer nicht zur teilweisen oder vollständigen Aussetzung oder Verzögerung der Zahlung innerhalb der vertraglich festgelegten Fristen.

5.4 Es wird vereinbart, dass die Gewährleistung aus dem vorliegenden Artikel nicht für die Verlegung sowie für Mängel und/oder Fehler gilt, die durch unsachgemäßen Gebrauch, Veränderung oder Abänderung der Produkte durch den Käufer verursacht sind.

6. Höhere Gewalt

6.1 Der Verkäufer kann bei Eintritt unvorhergesehener Ereignisse, die außerhalb seines Einflussbereiches liegen, die Ausführung des Vertrages einstellen und/oder vom Vertrag zurücktreten, wenn die Vertragserfüllung objektiv unmöglich ist oder einen unverhältnismäßigen Aufwand verlangt. Als solche Ereignisse gelten zum Beispiel Streik, Arbeitsstreit, Unfall, Explosion, Boykott, Aussperrung, Feuer, Krieg, Bürgerkrieg, Unruhen und Revolution, Epidemie, Beschlagnahme, Embargo, Unterbrechung der Energieversorgung, Überschwemmung, ge-

setzesrechtliche oder regierungsbehördliche Maßnahme oder Unterlassung, terroristische Handlungen, Versorgungsverzug oder -unmöglichkeit bei den eigenen Lieferanten, Ausfall von Maschinen oder wesentlichen Arbeitsausrüstungen und weitere gleichartige Ereignisse.

7. Korruptionsbekämpfung, Ethikkodex

7.1 Der Käufer verpflichtet sich, die Bestimmungen aller anwendbaren Gesetze, Vorschriften und Richtlinien jeglicher Behörde, Regierungsstelle oder weiteren nationalen oder internationalen Institution in Hinsicht auf Korruptionspraktiken und -vergehen („Anwendbares Recht“), einschließlich der Gesetze bezüglich unrechtmäßiger Geldzahlungen, Angebote, Geldversprechen oder Gewährung jeglicher anderweitiger Vorteile zugunsten von Beamten oder öffentlich-rechtlichen Angestellten für die Ausübung ihrer Aufgaben oder Ämter einzuhalten. Insbesondere verpflichtet sich der Käufer, die Bestimmungen des United States Foreign Corrupt Practices Act, der Convention on Combating Bribery of Foreign Officials in International Business Transactions (Konvention gegen die Bestechung ausländischer Amtsträger im internationalen Geschäftsverkehr) von 1997 und jedes weiteren Anwendbaren Rechts gegen die Korruption einzuhalten.

7.2 Der Käufer verpflichtet sich der Käufer, die Bestimmungen des United States Foreign Corrupt Practices Act, der Convention on Combating Bribery of Foreign Officials in International Business Transactions (Konvention gegen die Bestechung ausländischer Amtsträger im internationalen Geschäftsverkehr) von 1997 und jedes weiteren Anwendbaren Rechts gegen die Korruption einzuhalten.

7.3 Der Käufer verpflichtet sich im eigenen Namen und im Namen der eigenen Angestellten, Führungskräfte, Arbeiter, Mitarbeiter oder Berater, dass weder direkt noch indirekt jegliche Handlung in Ausführung jeglichen Vertrages durchgeführt wird, die gemäß dem Anwendbaren Recht ein Vergehen darstellen könnte. Insbesondere verpflichtet sich der Käufer im eigenen Namen und im Namen der eigenen Angestellten, Führungskräfte, Arbeiter, Mitarbeiter oder Berater, dass a) Beamten oder öffentlich-rechtlichen Angestellten, Beschäftigten oder Vertretern von Behörden, Regierungen oder jeglichen weiteren nationalen oder internationalen Institutionen keine Gaben, Geldzahlungen, Geschenke oder sonstige Vorteile; b) Bewerbern für ein öffentliches Amt kein Beitrag jeglicher Art angeboten, geleistet oder autorisiert werden. Der Käufer wird die Vorschriften gemäß ital. gesetzestvertretender Rechtsverordnung Nr. 231/2001 in der geltenden Fassung einhalten. Zu diesem Zweck erklärt der Käufer, den Ethikkodex des Verkäufers („Ethikkodex“) und das Management- und Kontrollorganisationsmodell gemäß ital. gesetzestvertretender Rechtsverordnung Nr. 231/2001 („Modell“) zu kennen. Der Ethikkodex, der Verhaltenskodex und das Modell sind im Internet auf der folgenden Website einsehbar: <https://www.emilgroup.com/downloadarea/> . Der Verkäufer verpflichtet sich, die Aufträge gemäß den Bestimmungen der Allgemeinen Geschäftsbedingungen in Übereinstimmung mit dem Modell auszuführen.

7.5 Der Käufer verpflichtet sich im eigenen Namen und im Namen seiner Angestellten, Führungskräfte, Arbeiter, Mitarbeiter oder Berater, die mit dem Verkäufer in Ausführung der Verträge in Kontakt kommen, dass der Verantwortliche des Verkäufers über jegliche Handlungen, Sachverhalte oder Aktionen informiert wird, von denen sie Kenntnis erlangen und die gemäß ital. gesetzestvertretender Rechtsverordnung Nr. 231/2001 ein Vergehen darstellen oder die verwaltungsrechtliche Haftung des Verkäufers im Sinne dieser Rechtsverordnung bewirken können.

7.6 Sollte sich der Käufer in Ausführung des Vertrages gemäß Art. 2635 ital. ZGB verhalten, ist der Verkäufer berechtigt, den Vertrag gemäß Art. 1456 ital. ZGB aufzulösen.

7.7 Bei Verletzung einer Pflicht aus Art. 73 und 75 durch den Käufer ist der Verkäufer berechtigt, den Vertrag gemäß Art. 1456 ital. ZGB aufzulösen.

7.8 Der Käufer erklärt und garantiert, dass er in Verbindung mit den Sanktionslisten der USA, der EU oder jeglichen anderen Landes, darunter, aber nicht darauf begrenzt, auch der U.S. Treasury Department Office of Foreign Assets Control's Specially Designated Nationals and Blocked Persons List weder aufgeführt wurde noch kontrolliert wird noch mit einem Subjekt in Verbindung steht, das in diesen Listen genannt ist. Der Käufer verpflichtet sich, vorgenannten Subjekten keine Produkte zu verkaufen oder in anderer Weise abzutreten. Der Käufer erklärt, die Vorschriften zu Wirtschaftssanktionen sowie Gesetze, Ausfuhrkontrollverordnungen der USA, der EU und jeglichen anderen Landes, darunter, aber nicht darauf begrenzt, auch die Vorschriften des Office of Foreign Assets Control, einzuhalten.

7.9 Bei Verletzung einer Pflicht, Erklärung oder Garantie aus Art. 78 durch den Käufer ist der Verkäufer berechtigt, den Vertrag gemäß Art. 1456 ital. ZGB aufzulösen.

8. Schutz der personenbezogenen Daten

8.1 Zu Zwecken der Vertragserfüllung verpflichten sich die Vertragsparteien, alle Vorschriften der Verordnung (EU) 2016/679 zum „Schutz natürlicher Personen bei der Verarbeitung personenbezogener Daten und zum freien Datenverkehr“ (in der Folge „DSGVO“ genannt) sowie, soweit anwendbar, der ital. gesetzestvertretenden Rechtsverordnung Nr. 196/2003 („Datenschutzkodex“), zuletzt geändert durch das gesetzestvertretende Dekret Nr. 101/2018 und gemäß den Verfügungen der zuständigen Datenschutzaufsichtsbehörden zu erfüllen.

8.2 Mit der Annahme des vorliegenden Vertrages vereinbaren die Vertragsparteien, dass personenbezogene Daten und/oder die personenbezogenen Daten der eigenen Mitarbeiter, die in die Ausführung der vertragsrelevanten Tätigkeiten eingebunden sind, durch den jeweils anderen Vertragspartner mitgeteilt und von diesem als selbstständigen Verantwortlichen zu Zwecken, die in engem Zusammenhang mit dem Abschluss und der Ausführung des Vertrages stehen, verarbeitet werden können.

8.3 Insbesondere stimmt der Käufer zu, dass die eigenen personenbezogenen Daten und/oder die personenbezogenen Daten der eigenen Beschäftigten und/oder Mitarbeiter, die in die Ausführung der vertragsrelevanten Tätigkeiten eingebunden sind, von dem Verkäufer als selbstständiger Verantwortlicher zu den Zwecken und nach den Modalitäten, die in der „Datenschutzerklärung - Kunden“ gemäß Art. 13 und 14 DSGVO auf der Website www.emilgroup.de unter Privacy verfügbar stehen. Der Käufer verpflichtet sich hiermit, diese den eigenen Beschäftigten und/oder Mitarbeitern zur Kenntnis zu bringen.

9. Beendigung des Vertrags

9.1 Der Verkäufer ist gemäß Art. 1456 ital. ZGB in den folgenden Fällen berechtigt, jeden Vertrag mit dem Käufer mit sofortiger Wirkung per Einschreiben zu auflösen, in dem er erklärt, von der hier genannten ausdrücklichen Auflösungsklausel Gebrauch machen zu wollen:

a) der Käufer erfüllt nicht die Pflichten gemäß Art. 3.9, 4 und 7 der vorliegenden Allgemeinen Geschäftsbedingungen;

b) der Käufer macht sich einer schweren Vertragsverletzung schuldig.

9.2 Der Verkäufer ist berechtigt, von jedem Vertrag mit dem Käufer mit sofortiger Wirkung per Einschreiben zurückzutreten, in dem er erklärt, von der hier genannten Klausel Gebrauch machen zu wollen:

a) in den Fällen gemäß Art. 1.3, 3.7, 6.1;

b) Einleitung eines Vollstreckungs-, Konkurs- oder Liquidationsverfahrens gegen den Käufer;

c) wenn die Vermögens-, Geschäfts- und Finanzlage des Käufers zur berechtigten Annahme veranlassen, dass sich der Käufer im Krisenzustand befindet;

d) wenn die Aktien und/oder der Mehrheits- oder Kontrollanteil vom Kapital des Käufers, falls dieser eine Gesellschaft ist, direkt oder indirekt verkauft oder veräußert werden oder als Sicherung gebunden sind.

10. Eigentumsvorbehalt

Der Verkäufer behält sich das Eigentum der Produkte bis zur vollständigen Begleichung des vereinbarten Kaufpreises vor. Demzufolge verpflichtet sich der Verkäufer, i) die unter Eigentumsvorbehalt stehenden Produkte pfleglich und bestimmungsgemäß zu behandeln; ii) das Eigentum und die Nutzungsrechte für die Produkte nicht an Dritte abzutreten, es sei denn, dies wurde zuvor ausdrücklich vom Verkäufer genehmigt. Kommt der Käufer innerhalb der vorgesehenen Zahlungsfrist teilweise oder vollständig in Zahlungsverzug, ist der Verkäufer berechtigt, die unter Eigentumsvorbehalt stehenden Produkte durch eine einfache Mitteilung wieder in Besitz zu nehmen. Unbeschadet der zuvor genannten Regelungen, haftet der Käufer für jedwede mögliche Schäden oder Verluste der Produkte nach deren Lieferung, auch wenn diese durch unvorhersehbare Ereignisse, höhere Gewalt oder andere nicht durch den Käufer verursachte Umstände verursacht wurden.

11. Anwendbares Recht - Gerichtsstand

11.1 Für diese Allgemeinen Geschäftsbedingungen und alle Verträge zwischen Käufer und Verkäufer gilt das italienische Recht.

11.2 Gerichtsstand für alle Streitigkeiten zwischen den Vertragsparteien über die Auslegung, Gültigkeit oder Ausführung dieser Allgemeinen Geschäftsbedingungen und aller Verträge ist ausschließlich Modena.

11.3 Die Vertragsparteien vereinbaren, dass nur der Verkäufer nach eigenem Ermessen berechtigt ist, auf den Gerichtsstand aus Art. 11.2 weiter oben zu verzichten, um den Käufer an seinem Wohnsitz und dem dort zuständigen Gericht zu belangen.

11.4 Zur Auslegung der Preisstellungsbedingungen und weiterer, eventuell von den Vertragsparteien verwendete Geschäftsbedingungen wird auf die Incoterms 2020 der Internationalen Handelskammer in Paris sowie auf die geltenden Gebräuche der Handelskammer Modena von 2005 für keramische Materialien verwiesen.

12. Marken und Unternehmenskennzeichen des Verkäufers

12.1 Der Käufer darf Marken, Namen oder anderweitige Erkennungszeichen des Verkäufers nur zur Identifizierung und Bewerbung der Produkte unter der Voraussetzung verwenden, dass dieser Gebrauch im ausschließlichen Interesse des Verkäufers liegt. Die Verwendung von Marken, Handelsnamen oder anderweitigen Erkennungszeichen des Verkäufers auf dem Geschäftspapier des Käufers, auf Werbematerial oder anderweitigem, an Dritte gerichtetem Material bedarf der vorherigen Genehmigung des Verkäufers.

12.2 Der Käufer verpflichtet sich, auf die Verwendung von Marken, Handelsnamen und Erkennungszeichen des Verkäufers in seiner eigenen Firma, Firmenbezeichnung, oder seinen Domains zu verzichten. Der Käufer verpflichtet sich in jedem Fall, die Marken und/oder Erkennungszeichen des Verkäufers nicht als Domains, einschließlich Web-Domains, zu registrieren.

12.3 Das Recht des Käufers zur Verwendung von Marken, Handelsnamen oder anderweitigen Erkennungszeichen des Herstellers gemäß Art. 12.1 weiter oben endet unmittelbar mit dem Ablauf oder der Auflösung aus welchem Grund auch immer dieser Allgemeinen Geschäftsbedingungen oder jeglichen Vertrages zwischen Käufer und Verkäufer.

12.4 Der Käufer benachrichtigt den Verkäufer über jegliche Rechtsverletzung hinsichtlich der Marken, Handelsnamen oder anderweitigen Erkennungszeichen des Verkäufers, von der er Kenntnis erlangt.

13. Schlussbestimmungen

13.1 Sollten Bestimmungen dieser Allgemeinen Geschäftsbedingungen gänzlich oder teilweise unwirksam sein, bleiben die anderen Bestimmungen hiervon unberührt.

13.2. Diese Allgemeinen Geschäftsbedingungen können ausschließlich vom Verkäufer schriftlich überarbeitet, ergänzt und geändert werden.

EMILCERAMICA

CONDICIONES GENERALES DE VENTA Y GARANTIAS

1. Disposiciones generales

1.1 Además de los términos y locuciones definidos en otros puntos de las presentes Condiciones Generales de Venta (definidas más abajo), los términos y locuciones que se enuncian a continuación deberán entenderse –cuando se indiquen con la letra inicial mayúscula– con el significado que se les atribuye convencionalmente o bien con el que se establece en el presente artículo 1.1:

- “Comprador”: la persona, física o jurídica, de la que el Vendedor (definido más abajo) recibe el pedido de compra;
- “Contrato”: el pedido de compra del Comprador, aceptado por el Vendedor, que incluye las Condiciones Generales de Venta (definidas más abajo);

• “EXW”: la disciplina de derechos y obligaciones del Comprador y el Vendedor (definido más abajo) prevista, con referencia al acrónimo de Ex Works (Franco Fábrica), por los Incoterms 2020 de la Cámara de Comercio Internacional de París;

- “Partes”: el Comprador y el Vendedor conjuntamente;
- “Productos”: los productos del Vendedor según se describen en las listas de precios y los catálogos vigentes cada año;

• “Vendedor”: Emilceramica S.r.l. a socio unico, con domicilio legal sito en Vía Ghiarola Nuova, 29 – 41042 Fiorano Modenese (Módena), Italia.

1.2 Los términos y las condiciones que se indican a continuación (las “Condiciones Generales de Venta”) forman parte integrante y substancial de cada uno de los Contratos estipulados entre el Vendedor y el Comprador en la compraventa de los Productos y prevalecerá sobre otras eventuales condiciones dispuestas por el Comprador, salvo que el Vendedor acepte estas últimas de manera explícita por escrito.

1.3 El Vendedor se reserva el derecho de modificar, integrar o variar las Condiciones Generales de Venta, adjuntando tales variaciones a las ofertas o bien a una comunicación escrita cualquiera que le envíe al Comprador. En caso de que el Comprador no acepte las modificaciones, integraciones o variaciones de las Condiciones Generales de Venta en el plazo de quince días a contar desde la fecha de su comunicación, valdrán las Condiciones Generales de Venta aceptadas anteriormente, sin menoscabo de la potestad del Vendedor de ejercer su derecho de resoición en el plazo de los treinta días subsiguientes.

2. Ofertas y pedidos

2.1 La oferta que le hayan formulado al Comprador agentes, intermediarios comerciales u otros intermediarios y la propuesta de pedido que estos le presenten al Vendedor solo será vinculante para este último a partir del momento en que acepte el pedido del Comprador de conformidad con lo que se enuncia a continuación en el artículo 2.2.

2.2 El pedido efectuado por el Comprador solo se considerará admitido cuando el Vendedor exprese por escrito su aceptación. En caso de que el Vendedor no exprese por escrito la aceptación de un pedido, la emisión de la factura o la ejecución del pedido por parte del Vendedor deberán entenderse como señal inequívoca de su aceptación.

3. Términos de las entregas

3.1 La entrega de los Productos se producirá EXW. El Vendedor procederá a la entrega poniendo los Productos a disposición del Comprador de acuerdo con los términos y en los lugares especificados en el Contrato (“Entrega”). En el momento de la Entrega el Vendedor asume únicamente la obligación de cargar los Productos en el vehículo dispuesto para su recogida, por lo que se excluye cualquier otra obligación.

3.2 El Vendedor no será responsable de las pérdidas o daños que pudieren sufrir los Productos después de su Entrega; el Comprador no quedará exento en ningún caso de la obligación de pagar el precio de los Productos una vez realizada la Entrega.

3.3 Con la salvedad de los supuestos enunciados más adelante en el artículo 9, la Entrega se podrá suspender en todos los casos en que el Comprador incumpla su obligación de pagar el precio de los Productos.

3.4 Los plazos de entrega y devolución de los Productos —aun cuando se definan come taxativos— se entienden de todos modos como meramente orientativos y el Vendedor los asume con el margen de tolerancia que dicta la costumbre. El plazo de Entrega —en cualquier caso orientativo— será única y exclusivamente el que se indique en el documento de aceptación del pedido por parte del Vendedor.

3.5 En caso de que el retraso en la Entrega exceda los márgenes de tolerancia que dicta la costumbre, el Comprador podrá anular únicamente la parte del pedido correspondiente a los Productos cuya Entrega no se produzca en el plazo de los treinta días inmediatamente posteriores a la fecha en que el Vendedor reciba la comunicación de anulación cursada por el Comprador, que deberá enviarse a través de carta certificada con acuse de recibo o correo electrónico certificado.

3.6 El comprador no podrá anular su pedido, ni rescindir el Contrato, en caso de que el retraso en la Entrega se deba a causas de fuerza mayor, según se exponen más adelante en el artículo 6, siempre y cuando la demora en la Entrega no supere los sesenta días.

3.7 El Vendedor podrá rescindir el Contrato, notificándoselo al Comprador mediante comunicación escrita, en caso de que se den causas de fuerza mayor como las que se enuncian más adelante en el artículo 6.

3.8 Si la Entrega no se produce por un hecho imputable al Comprador, se considerará ejecutada, a todos los efectos (incluido el efecto de los plazos de pago y la emisión de la factura), con la mera comunicación al Comprador de que los Productos se hallan a su disposición; transcurridos quince días desde la fecha de la comunicación empezarán a cargarse gastos de almacén y el Vendedor quedará exento de toda responsabilidad con respecto al deterioro, los daños o, en cualquier caso, la pérdida de valor que puedan sufrir los Productos.

3.9 El Comprador se compromete a comunicarle al Vendedor la no entrega de los Productos en el lugar de destino indicado en el albarán de transporte o la entrega efectiva de los Productos en un lugar distinto del indicado en el albarán de transporte en el plazo de

las ciento veinte horas inmediatamente posteriores a la fecha prevista para la entrega en el lugar de destino, mediante una carta certificada con acuse de recibo o correo electrónico certificado que incluya una copia del albarán de transporte firmado. Tras la recepción de la susodicha comunicación acompañada de la documentación, el Vendedor procederá a regularizar las facturas emitidas aplicando el IVA de conformidad con el Decreto del Presidente de la República italiana nº 600/1973. Se da por acordado que el Comprador se compromete a eximir al Vendedor de impuestos, sobretasas, intereses y sanciones de cualquier clase, así como de costas legales, en caso de adeudos efectuados por la Administración de Hacienda a su cargo, derivados de la falta de comunicación por escrito o, en cualquier caso, de la entrega de los Productos en un lugar de destino distinto del indicado en el albarán de transporte. El Comprador, teniendo constancia de la comunicación que el Vendedor exige al transportista que se firme, se compromete asimismo a comunicarle al propio transportista cualquier cambio o modificación del destino de los Productos. El incumplimiento de dicha obligación conllevará que el Vendedor le adeude al Comprador eventuales impuestos, sobretasas, intereses y sanciones de cualquier clase, así como gastos legales, en caso de que, como consecuencia de dicha falta de comunicación, la Administración de Hacienda ponga reparos.

3.10 Se exime de toda responsabilidad al Vendedor por daños debidos al retraso o a la falta de entrega (total o parcial) de los Productos, salvo en caso de fraude o culpa grave.

4. Precios y términos de los pagos

4.1 Los precios de los Productos indicados en las listas vigentes cada año deben entenderse Franco Fábrica; como consecuencia de ello cualquier otro desembolso o gasto correspondiente al envío, la entrega y/o el transporte de los Productos correrá a cargo del Comprador exclusivamente. La provisión de fondos necesaria para afrontar eventuales desembolsos o gastos a cargo del Comprador deberá, en ese caso, serle adelantada por este último al Vendedor; a mero título de ejemplo, sin voluntad de exhaustividad, tales costes y gastos comprenden el coste del embalaje añadido, el del transporte, los costes accesorios, los impuestos, las pólizas, los gastos aduaneros y cualquier otro desembolso añadido no incluido en los precios. Los precios de los Productos pueden ser objeto de correcciones para enmendar errores de imprenta.

4.2 Los precios de los Productos no incluyen el IVA determinado por la ley, que deberá ser satisfecho de conformidad con lo indicado en la factura.

4.3 El lugar de pago será el domicilio legal del Vendedor incluso en caso de emisión de giros o recibos bancarios, o bien de emisión de efectos cambiarios. La eventual aceptación por parte del Vendedor de letras de cambio, pagarés, cesiones o cheques bancarios se considera siempre acordada “salvo buen fin” y/o pro solvendo y sin novación de la deuda. El pago se satisfará de manera íntegra en el acto de la Entrega de los Productos, salvo que, por escrito, se convenga saldarlo de otro modo.

4.4 Además del resto de supuestos previstos por la ley y/o en el Contrato, el Vendedor aplicará intereses de demora sobre los pagos satisfechos con retraso, de conformidad con lo previsto en el Decreto Legislativo italiano nº 231 de 2002.

5. Términos de la garantía

5.1 El Vendedor garantiza que los Productos están exentos de vicios y defectos a lo largo de un período de doce meses a contar desde la fecha de entrega. La garantía se atiene a los límites establecidos en el artículo 1495 del Código Civil italiano, sin menoscabo de las limitaciones enunciadas en este artículo y en la compilación provincial de usos de 2005 de la Cámara de Comercio de Módena en referencia a los materiales cerámicos, así como a los márgenes de tolerancia dictados por la costumbre. Las eventuales indicaciones de pesos, medidas, dimensiones, colores, tonalidades y otros datos incluidos en catálogos, folletos y carpetas del Vendedor tienen un carácter meramente orientativo y no son vinculantes. La garantía del Vendedor, en cualquier caso, se limita a los productos de primera calidad, es decir, según lo indicado en la compilación provincial de usos de 2005 de la Cámara de Comercio de Módena en referencia a los materiales cerámicos, con un porcentaje de azulejos defectuosos no superior al 5%, solamente con respecto a la parte que exceda dicho porcentaje; la garantía queda, pues, expresamente excluida en relación con Productos distintos de los de primera calidad. Las diferencias de tonalidad con respecto a lo que se hubiere podido acordar no podrán ser denunciadas como defectos de los Productos, salvo en caso de fraude o culpa grave.

5.2 Con la obligación de la garantía el Vendedor se compromete a substituir el producto dañado y/o defectuoso, si bien ateniéndose a los límites establecidos en el Contrato y en cualquier caso sin ninguna obligación adicional de resarcimiento por daños directos y/o indirectos y/o consiguientes causados al Comprador y/o a terceras personas por defectos de los Productos, sin perjuicio de lo iderogablemente dispuesto por la ley. En cualquier caso las Partes reconocen que la responsabilidad global del Vendedor para con el Comprador se limita al precio pagado por el Comprador en referencia a los Productos que han dado origen a la responsabilidad del Vendedor.

5.3 En cualquier caso la garantía por vicios y defectos dejará de ser eficaz una vez efectuada la colocación o montaje de los Productos; por consiguiente las reclamaciones deberán presentarse antes de la colocación, mediante carta certificada con acuse de recibo o correo electrónico certificado que dirigir al Vendedor y habrán de documentar de manera detallada los vicios y defectos detectados. Las reclamaciones no le darán el derecho al Comprador de suspender o retrasar, ni total ni parcialmente, el pago dentro de los plazos convenidos en el Contrato.

5.4 Se da por acordado que la garantía a la que se refiere el presente artículo no comprenden la colocación y no tendrá eficacia cuando el vicio y/o el defecto de los Productos se deban a un uso incorrecto o bien a la modificación o alteración de los mismos, imputables al Comprador.

6. Fuerza mayor

6.1 El Vendedor puede suspender la ejecución del Contrato y/o rescindirlo en caso de que su cumplimiento resulte objetivamente imposible o exoesivamente gravoso a causa de un acontecimiento imprevisible independiente de su voluntad como, por ejemplo, huelga, conflicto sindical, accidente, explosión, boicót, cierre patronal, incendio, guerra, guerra civil, revuelta y revolución, epidemia, incautación, embargo, corte de energía, inundación, acción u omisión legal o gubernamental, acto de terrorismo, retraso o imposibilidad de aprovisionamiento de los proveedores, averías de máquinas o equipos esenciales y otras causas análogas a las referidas.

7. Disposiciones contra la corrupción. Código ético

7.1 El Comprador observará lo dispuesto por las leyes, reglamentos y directivas de toda autoridad, ente gubernamental u otra institución nacional o internacional que sean de aplicación con respecto a prácticas y delitos de corrupción (“Ley Aplicable”), incluidas las leyes referidas a pagos ilícitos, ofertas, promesas de dinero o cualquier otro beneficio a favor de funcionarios públicos o encargados de prestar servicios públicos para el desempeño de sus funciones o poderes.

7.2 En particular, el Comprador observará lo dispuesto en la ley U.S. Foreign Corrupt Practices Act, por la Convention on Combating Bribery of Foreign Officials in International Business Transactions de 1997 y cualquier otra Ley Aplicable con respecto a la corrupción.

7.3 El Comprador se compromete, en su nombre y en el de sus empleados, administradores, trabajadores, colaboradores o asesores, a no realizar, ni directa ni indirectamente, ninguna acción, en la ejecución de cualquier contrato, que pueda constituir delito con arreglo a lo previsto en cualquiera de las Leyes Aplicables. En particular, el Comprador se compromete, en su nombre y en el de sus empleados, administradores, trabajadores, colaboradores o asesores, a no ofrecer, dar ni autorizar: a) ningún soborno, pago ni gratificación, como tampoco ningún otro beneficio a funcionarios públicos o encargados de prestar servicios públicos, empleados o agentes de cualquier autoridad, ente gubernamental, o de cualquier otra institución nacional o internacional; b) ninguna contribución, de la naturaleza que fuere, a ningún candidato al desempeño de un mandato público.

7.4 El Comprador observa lo dispuesto en el Decreto Legislativo italiano nº 231/2001, según se modificó e integró. Para ello, el Comprador declara que conoce el Código Ético del Vendedor (“Código Ético”) y el Modelo de organización, gestión y control previsto en el Decreto Legislativo italiano nº 231/2001 (“Modelo”). El Código Ético y el Modelo se pueden consultar accediendo al siguiente sitio web: <https://www.emilgroup.com/downloadarea/> . El Vendedor se compromete a cursar los pedidos de acuerdo con lo previsto en las presentes Condiciones Generales de Venta y de conformidad con el Código Ético y el Modelo.

7.5 El Comprador se compromete, en su nombre y en el de los empleados, administradores, trabajadores, colaboradores o asesores que entren en contacto con el Vendedor en la ejecución de los Contratos, a informar al responsable del Vendedor de todo acto, acción o hecho del que aquellos se enteren, que pueda constituir alguno de los delitos previstos en el Decreto Legislativo italiano nº 231/2001 o, en cualquier caso, que pueda implicar la responsabilidad administrativa del Vendedor, de conformidad con dicha ley. Si durante la ejecución del Contrato el Comprador incurre en alguna de las conductas descritas en el artículo 2635 del Código Civil italiano, el Vendedor tendrá derecho a rescindir el Contrato, de acuerdo con el artículo 1456 del Código Civil italiano.

7.7 En caso de que el Comprador incumpla alguna de las obligaciones enunciadas en los artículos 7.3 y 7.5, el Vendedor tendrá derecho a rescindir el Contrato, de acuerdo con el artículo 1456 del Código Civil italiano.

7.8 El Comprador declara y garantiza que no ha sido designado, no está asociado ni es controlado por ninguna de las personas incluidas en las listas restrictivas de los EE.UU. de América, la Unión Europea ni de ningún país, incluida, sin limitaciones, la U.S. Treasury Department Office of Foreign Assets Control’s Specially Designated Nationals and Blocked Persons List; el Comprador se compromete asimismo a no vender ni transferir a otro título Productos a dichas personas. El Comprador declara que observa las prescripciones relativas a las sanciones económicas, leyes y reglamentos de control acerca de la exportación vigentes en los EE.UU. de América, en la Unión Europea y en cualquier país, incluidos, sin limitaciones, los reglamentos dispuestos por la Office of Foreign Assets Control.

7.9 En caso de que el Comprador incumpla alguna de las obligaciones, declaraciones y garantías referidas más arriba en el punto 7.8 el Vendedor tendrá derecho a rescindir el Contrato, de acuerdo con el artículo 1456 del Código Civil italiano.

8. Protección de los datos personales

8.1 A efectos de la ejecución del Contrato las Partes se comprometen a atenerse a las obligaciones dictadas por el Reglamento General (UE) 2016/679 en lo que concierne a la “protección de las personas físicas en lo que respecta al tratamiento de datos personales y a la libre circulación de estos datos” (en adelante “RGPD”), así como, en la medida de su aplicabilidad, al Decreto Legislativo italiano 196/2003 (“Código de Privacidad”), modificado en último lugar por el Decreto Legislativo italiano 101/2018 y a las disposiciones de la Autoridad Garante de la protección de los datos personales.

8.2 Al suscribir el presente Contrato, cada una de las Partes, en lo que sea de su competencia, acepta que sus datos personales y/o los de sus empleados y/o colaboradores, implicados en las actividades de ejecución del Contrato, le podrán ser comunicados a la otra parte y ser tratados por esta última en su condición de Responsable independiente del tratamiento para fines estrictamente vinculados a la estipulación y la ejecución del Contrato.

8.3 En particular, al Comprador le consta que sus datos personales y/o los de sus emplea-

dos y/o colaboradores, involucrados en las actividades a las que se refiere el Contrato, serán tratados por el Vendedor en su condición de Responsable independiente del tratamiento para los fines y con arreglo a las formas indicadas en la “Nota Informativa de los Clientes”, facilitada de conformidad con lo establecido en los artículos 13 y 14 del RGPD disponible en el sitio web www.emilgroupes bajo el apartado Privacy, que el Comprador se obliga desde ya a poner en conocimiento de sus empleados y/o colaboradores.

9. Cesación del contrato

9.1 El Vendedor tendrá derecho a rescindir cualquier Contrato estipulado con el Comprador, con efecto inmediato, de conformidad con el artículo 1456 del Código Civil italiano, a través de una comunicación enviada mediante carta certificada en la que declare que desea acogerse a la presente cláusula resolutoria expresa, en los casos siguientes:

a) que el Comprador no cumpla las obligaciones referidas en los artículos 3.9, 4 y 7 de las presentes Condiciones Generales de Venta;

b) que el Comprador sea responsable de un grave incumplimiento contractual.

9.2 El Vendedor tendrá derecho a rescindir con efecto inmediato cualquier Contrato a través de una comunicación que le enviará al Comprador, mediante carta certificada, en la que declare que quiere acogerse a la presente cláusula:

a) en los casos enunciados en los puntos 1.3, 3.7, 6.1.

b) en caso de que el Comprador esté sometido a procedimientos ejecutivos, concursales o de liquidación;

c) en caso de que las condiciones patrimoniales, económicas y financieras del Comprador permitan presumir razonablemente que este se encuentra en estado de crisis; d) en caso de que las acciones y/o la cuota de representación de la mayoría o del control del capital social del Comprador, cuando esté constituido en forma de sociedad, sean directa o indirectamente cedidas, enajenadas o vinculadas a una garantía.

10. Reserva de propiedad

El Vendedor es propietario de los Productos hasta el momento del pago íntegro del precio convenido. Por consiguiente el Comprador se obliga a i) usarlos correctamente, de acuerdo con la utilización prevista; ii) no trasladar a terceras personas su propiedad ni su disfrute, a menos que el Vendedor, previamente y de forma explícita, le haya autorizado a hacerlo. En caso de que el Comprador no haya satisfecho el importe total de los suministros antes del vencimiento del plazo previsto, el Vendedor podrá recuperar, mediante simple solicitud, la posesión de los productos entregados. Sin menoscabo de lo hasta aquí enunciado, el Comprador es responsable de todo daño o pérdida que se haya producido después de la entrega, aun cuando se deba a circunstancias fortuitas, de fuerza mayor o a circunstancias que no se le puedan achacar al Comprador.

11. Ley aplicable – Fuero competente

11.1 Las presentes Condiciones Generales de Venta y todos los Contratos estipulados entre el Comprador y el Vendedor se regulan de acuerdo con la ley italiana.

11.2 Para dirimir toda controversia que surja entre las Partes acerca de la interpretación, la validez o la ejecución de las presentes Condiciones Generales de Venta y de todos los Contratos se acudirá a la competencia exclusiva del Tribunal de Módena.

11.3 Las Partes convienen que solo el Vendedor, a su libre discreción, tiene la facultad de renunciar a la competencia exclusiva del fuero al que se hace referencia más arriba en el artículo 11.2 para actuar en juicio contra el Comprador en su domicilio y en el Tribunal competente en aquel lugar.

11.4 Con el fin de interpretar los términos de devolución y los demás términos comerciales eventualmente ejecutados por las Partes se remite a los Incoterms de 2020 de la Cámara de Comercio Internacional de París y a los usos de 2005 de la Cámara de Comercio de Módena en relación con los materiales cerámicos.

12. Marcas y signos distintivos del Vendedor

12.1 El Comprador deberá usar las marcas, nombres o demás signos distintivos del Vendedor, si bien con el único fin de identificar y publicitar los Productos, dándose por sentado que dicho uso se realiza exclusivamente en interés del Vendedor. Sin embargo, todo uso de las marcas, nombres o demás signos distintivos del Vendedor en el papel con membrete del Comprador, en su material publicitario o en cualquier otro material destinado a terceras personas deberá convenirse previamente por escrito con el Vendedor.

12.2 El Comprador se compromete a no introducir las marcas, nombres y signos distintivos del Vendedor en su empresa, denominación social ni en sus dominios web. En cualquier caso, el Comprador se compromete a no registrar las marcas ni los signos distintivos del Vendedor incluidos dominios web.

12.3 El derecho del Comprador de emplear las marcas, nombres o demás signos distintivos del Preponente, tal como se ha descrito más arriba en el artículo 12.1, cesará inmediatamente en el momento del vencimiento o resolución, por la causa que fuere, de las presentes Condiciones Generales de Venta o del Contrato que hayan estipulado el Comprador y el Vendedor.

12.4 El Comprador informará al Vendedor de toda violación de las marcas, nombres o demás signos distintivos del Vendedor de la que se entere.

13. Disposiciones Finales

13.1 La invalidez total o parcial de alguna de las disposiciones de las presentes Condiciones Generales de Venta no anula la eficacia del resto de medidas.

13.2 Solo el Vendedor podrá modificar, integrar o variar las presentes Condiciones Generales de Venta, y deberá hacerlo por escrito.

EMILCERAMICA

1. Общие положения

1.1 В дополнение к терминам и словосочетаниям, которые приводятся в других параграфах данных Общих условий продажи (определяются ниже), перечисленные ниже термины и словосочетания в написании с заглавной буквы имеют обычное значение или же изложенное в данной ст. 1.1:

- **«Покупатель»:** физическое или юридическое лицо, от которого Продавец (определяется ниже) получает заказ на закупку;
- **«Контракт»:** заказ на закупку Покупателя, принятый Продавцом, включающий в себя Общие условия продажи (определяются ниже);
- **«EXW»:** комплекс прав и обязанностей Покупателя и Продавца (определяется ниже), являющийся аббревиатурой Ex Works (франко-завод), предусмотренный правилами Incoterms 2020 Парижской международной торговой палаты;
- **«Стороны»:** совокупно Покупатель и Продавец;
- **«Продукция»:** продукция Продавца, представленная в составляемых на каждый год прайс-листах и каталогах;
- **«Продавец»:** Emilceramica S.r.l. a socio unico, юридический адрес: Via Ghiarola Nuova, 29 – 41042 Fiorano Modenese (MO), Италия.

1.2 Изложенные ниже положения и условия («Общие условия продажи») являются неотъемлемой и существенной частью каждого Контракта, заключенного между Продавцом и Покупателем для купли-продажи Продукции, и имеют преобладающую силу над условиями, предлагаемыми Покупателем, если отсутствует специальное письменное принятие их Продавцом.

1.3 Продавец оставляет за собой право на изменение, дополнение или модификацию данных Общих условий продажи, прилагая эти изменения к офертам или же к любым письменным сообщениям, отправляемым Покупателю. В тех случаях, если изменения, дополнения или модификации Общих условий продажи не принимаются Покупателем в течение 15 дней с даты отправки сообщения, то будут действовать ранее принятые Общие условия продажи с правом расторжения договоренностей Продавцом в течение последующих 30 дней.

2. Оферты и заказы

2.1 Оферта, выставленная Покупателю агентами, представителями или другими посредниками, и предложение заказа, отправленное ими Продавцу, не является для последнего обязательным до тех пор, пока заказ Покупателя на бюджет принят Продавцом в соответствии с изложенной ниже ст. 2.2.

2.2 Выставленный Покупателем заказ не считается принятым до тех пор, пока он не подтвержден в письменной форме Продавцом. В том случае, если Продавец не дал письменного подтверждения заказа, выписка счета-фактуры или же выполнение заказа Продавцом должны считаться фактом принятия заказа.

3. Условия поставки

3.1 Поставка Продукции осуществляется на условиях EXW. Продавец выполняет поставку, предоставляя Продукцию в распоряжение Покупателя в сроки и в местах, которые указываются в Контракте («Поставка»). При выполнении Поставки Продавец возлагает на себя обязательство лишь только по погрузке Продукции на вывозящее ее транспортное средство, исключая любые другие обязательства.

3.2 Продавец не несет ответственности за какие-либо потери или ущерб Продукции после Поставки. Покупатель ни в коем случае не освобождается от оплаты стоимости Продукции после ее Поставки.

3.3 Исключая случаи, оговоренные в нижеприведенной ст. 9, Поставка может быть приостановлена во всех случаях невыполнения Покупателем обязательства оплаты стоимости Продукции.

3.4 Все сроки поставки и возврата Продукции, даже если они определяются как обязательные, считаются приблизительными и принимаются Продавцом с практическими допущениями. Сроком Поставки, который является приблизительным, считается лишь только срок, указанный в подтверждении заказа Продавца.

3.5 В случае, если задержка Поставки выводит за практические допуски, Покупатель может аннулировать лишь только ту часть заказа, которая относится к Продукции, Поставка которой не произойдет в течение 30 дней после получения Продавцом сообщения Покупателя об аннуляции, которое должно быть отправлено заказным письмом с уведомлением о вручении или по сертифицированной электронной почте.

3.6 Покупатель не может аннулировать свой заказ, а также расторгнуть Контракт в случае задержки Поставки, вызванной форс-мажорными обстоятельствами, изложенными в ст. 6 ниже, если задержка Поставки не превышает 60 дней.

3.7 Продавец может расторгнуть Контракт путем отправки Покупателю письменного сообщения в случае возникновения форс-мажорных обстоятельств, оговоренных в ст. 6 ниже.

3.8 Если же Поставка не выполняется по вине Покупателя, то она считается полностью выполненной (включая отсчет сроков оплаты и выставления счета-фактуры) путем простого сообщения Покупателю о предоставлении Продукции в его распоряжение. По истечении 15 дней с даты сообщения начинается начисление складских расходов, а Продавец освобождается от любой ответственности за порчу, повреждение или же потерю ценности Продукции.

3.9 Покупатель обязуется сообщить Продавцу о невыполнении поставки Продукции по месту, указанному в транспортной документации, или же о поставке Продукции в ином месте, не являющемся указанным в транспортной документации, в течение 120 часов после предусмотренной даты поставки по месту назначения, отправив заказное письмо с уведомлением о вручении или же по сертифицированной электронной почте, приложив копию подписанного транспортного документа. После получения вышеназванного сообщения, включающего в себя документацию, Продавец оформит выставленные счета-фактуры с взиманием НДС, согласно Указу Президента Республики № 600/1973. Подразумевается, что Покупатель обязуется освободить Продавца от взимания налогов, дополнительных сборов, процентов и штрафов любого характера, а

также от юридических расходов, в случае их возложения на него финансовыми органами, вытекающих из неполучения письменного сообщения или же из поставки Продукции в ином месте, отличающемся от указанного в транспортной документации. Приняв к сведению сообщение, подписание которого Продавец требует от грузоперевозчика, Покупатель также обязуется сообщить грузоперевозчику о всех изменениях пункта назначения Продукции. Невыполнение этого обязательства влечет взимание Продавцом с Покупателя возможных налогов, дополнительных сборов, процентов и штрафов любого характера, а также юридических расходов, в случае обнаружения финансовыми органами нарушений, вызванных отсутствием данных сообщений.

3.10 Исключая случаи предумышленных действий или серьезной вины, исключается любая ответственность Продавца за ущерб, вытекающий из задержки (полной или частичной) или невыполнения Поставки Продукции.

4. Цены и Условия платежей

4.1 Цены на Продукцию, указанные в составляемых на каждый год прайс-листах и каталогах, подразумевают условия поставки EXW. Из этого следует, что любые другие расходы или траты, касающиеся отправки, поставки и/или перевозки Продукции, относятся лишь только на счет Покупателя. Сумма, необходимая на выплату расходов, возлагающихся на Покупателя, в этом случае должна быть авансирована им Покупателю. В качестве примерного и неисчерпывающего перечня в эти расходы входит стоимость дополнительной упаковки, стоимость перевозки, вспомогательные расходы, налоги, гербовые сборы, таможенные сборы, а также любой другой дополнительный расход, не включенный в цены. Цены на Продукцию могут претерпевать корректировку, вызванную опечатками.

4.2 Подразумевается, что цены на Продукцию не включают в себя предусмотренный законом НДС, который должен выплачиваться в соответствии с данными в счете-фактуре.

4.3 Местом оплаты назначается юридический адрес Продавца, даже в случае выписки банковского тратты или ордера, то есть, в случае выпуска переводных векселей. Подразумевается, что акцептование Продавцом векселей, долговых обязательств, уступок или банковских чеков произойдет только в случае успеха и/или с регрессом, без новации долгового обязательства. При отсутствии иных письменных договоренностей, обязательство оплаты полной стоимости Продукции возникает в момент Поставки.

4.4 В дополнение к другим мерам, которые предусматриваются законом и/или Контрактом, Продавец взимает проценты по задолженности в соответствии с положениями Декрета-Закона № 231 от 2002 г.

5. Гарантийные условия

5.1 Продавец гарантирует, что Продукция не имеет пороков и дефектов в течение 12 месяцев с даты поставки. Гарантия действует в пределах, определенных в ст. 1495 Г.К., с дополнительными ограничениями, изложенными в данной статье и Провинциальном сборнике практик 2005 г. Торговой палаты Модены применительно к керамическим материалам, а также с обычно действующими допущениями. Указания весов, измерений, размеров, цветов, тонов и других данных, содержащихся в каталогах, брошюрах и проспектах Продавца, имеют лишь только иллюстративный характер и не являются обязательными. В любом случае, гарантия Продавца распространяется лишь только на Продукцию первого сорта, то есть, в соответствии с Провинциальным сборником практик 2005 г. Торговой палаты Модены применительно к керамическим материалам, с содержанием дефектной плитки не более 5%, лишь только на ту часть, которая превышает этот процент. Из гарантии однозначно исключается Продукция, не являющаяся Первым сортом. Исключая случаи предумышленных действий и серьезной вины, разнотон, отличающийся от согласованного, не может рассматриваться как дефект Продукции.

5.2 В рамках гарантийных обязательств Продавец обязуется заменить продукцию с пороками и/или дефектами в рамках Контракта, в любом случае, без каких-либо дополнительных обязательств по возмещению прямого и/или косвенного и/или вытекающего ущерба, нанесенного Покупателю и/или третьим лицам дефектами Продукции, исключая неотложные положения законодательства. В любом случае, стороны признают, что общая ответственность Продавца по отношению к Покупателю ограничивается выплаченной Покупателем стоимостью Продукции, которая стала причиной ответственности Продавца.

5.3 В любом случае, гарантия от пороков и дефектов отменяется в случае укладки Продукции, поэтому, рекламация должна предьявляться до укладки заказным письмом с уведомлением о вручении или же по сертифицированной электронной почте, отправленным Продавцу с подробным документальным подтверждением обнаруженных пороков и дефектов. Рекламация не дает Покупателю право на полное или частичное прекращение или задержку оплаты в установленные Контрактом сроки.

5.4 Подразумевается, что описанная в данной статье гарантия отменяется в случае укладки изделий, а также в тех случаях, в которых порок и/или дефект Продукции зависит от неправильного использования, изменений или модификаций Продукции, выполненных Покупателем.

6. Форс-мажор

6.1 Продавец может прервать и/или прекратить выполнение Контракта в случае, если выполнение станет объективно невозможным или же чрезмерно затратным по причине непредвиденного события, не зависящего от его воли, такого как, например: забастовка, профсоюзные споры, авария, взрыв, бойкот, локаут, пожар, война, гражданская война, народные волнения и революция, эпидемия, секвестр, эмбарго, прекращение энергоснабжения, затопление, действие или недействие законодательства или правительства, теракт, задержка или невозможность снабжения от своих поставщиков, поломки основных машин или оборудования, а также другие причины, аналогичные вышеизложенным.

7. Противодействие коррупции. Этический кодекс

7.1 Покупатель соблюдает положения всех применимых законов, регламентов, директив любых органов власти, госучреждений или других государственных или международных структур, касающиеся практик и незаконных действий в сфере коррупции («Применимый закон»), включая законы, касающиеся незаконной оплаты, оферт, обещаний денежных сумм или любой другой выгоды для государственных должностных или уполномоченных лиц государственных служб для выполнения их функций или полномочий.

7.2 В частности, Покупатель соблюдает положения *Закона о коррупции за рубежом (США), Конвенции ОЭСР о борьбе с подкупом иностранных должностных лиц в международных коммерческих сделках 1997 г.* и любой другой Применимый закон, касающийся коррупции.

7.3 Покупатель обязуется, что при выполнении каких-либо контрактов ни он, ни его должностные лица, управляющие, работники, сотрудники или консультанты, не будут совершать напрямую или косвенно никаких действий, которые могут представлять собой незаконные поступки, как предусматривается любым Применимым законом. В частности, Покупатель обязуется, что ни он, ни его должностные лица, управляющие, работники, сотрудники или консультанты, не будут предлагать, давать или разрешать а) какую бы то ни было компенсацию, оплату, подарки или любую другую выгоду должностным лицам или же уполномоченным лицам госслужбе, персоналу или агентам любых органов власти, госструктур, а также любых других государственных или международных учреждений; б) любое вознаграждение, любого характера, кому бы то ни было, на кого будет возложено выполнение государственных обязанностей.

7.4 Покупатель соблюдает положения Декрета-закона 231/2001 с его изменениями и дополнениями. В этих целях Покупатель заявляет о знании Этического кодекса Продавца («Этический кодекс»), а также Модели организации менеджмента и контроля, предусмотренного Декретом-законом 231/2001 («Модель»). С Этическим кодексом, Кодексом поведения и Моделью можно ознакомиться на следующем сайте: <https://www.emilgroup.it/downloadarea/>. Продавец обязуется составлять заказы согласно положениям данных Общих условий продажи, в соответствии с Этическим кодексом и Моделью.

7.5 Покупатель обязуется, что он, его должностные лица, управляющие, работники, сотрудники или консультанты, контактирующие с Продавцом для выполнения Контрактов, будут информировать ответственное лицо Продавца о любом акте, факте или действии, о котором они могут узнать, и который может являться преступлением, предусмотренным Декретом-Законом 231/2001, или который может повлечь административную ответственность Продавца в рамках этого закона.

7.6 Если во время выполнения Kontakта Покупатель выполняет действия, описанные в ст. 2635 Г.К., то Продавец будет иметь право на расторжение Контракта в соответствии со ст. 1456 Г.К.

7.7 В случае нарушения Покупателем одного из обязательств, описанных в ст. 7.3 и 7.5, Продавец имеет право расторгнуть Контракт в соответствии со ст. 1456 Г.К.

7.8 Покупатель заявляет и гарантирует, что он не включен, не находится под контролем и не связан с каким бы то ни было субъектом, включенным в ограничительный список субъектов США, ЕС или других стран, включая, но не ограничиваясь: *Список специально выделенных граждан и блокированных лиц Управления по контролю за иностранными активами США*, а также Покупатель обязуется не продавать Продукцию и не передавать ее под другими предлогами вышеназванным субъектам. Покупатель заявляет, что он соблюдает предписания по экономическим санкциям, а также законы, контролирующие регламенты экспорта, действующие в США, ЕС и любой другой стране, включая, но не ограничиваясь, дисциплинарные регламенты Управления по контролю за иностранными активами.

7.9 В случае нарушения Покупателем какого-либо обязательства, декларации и гарантии, описанных в ст. 7.8, Продавец имеет право расторгнуть Контракт в соответствии со ст. 1456 Г.К.

8. Защита персональных данных

8.1 В целях выполнения контракта Стороны обязуются выполнять все обязанности, предусмотренные Общим регламентом (ЕС) 2016/679, касающиеся «защиты физических лиц в сфере обработки персональных данных и свободного обращения этих данных» (далее «ОРЗД»), а также в пределах соответствующей применимости - Декретом-Законом 196/2003 («Кодекс конфиденциальности») с последним изменением, внесённым Декретом-Законом 101/2018, а также предусмотренные распоряжениями Омбудсмена по защите персональных данных.

8.2 Принимая данный Контракт, каждая Сторона в пределах своей компетенции признает, что ее персональные данные и/или ее персонала и/или сотрудников, привлеченных к оговоренной в Контракте деятельности, будут обрабатываться Продавцом в качестве Автономного оператора обработки данных и обрабатываться ею в качестве Автономного оператора обработки данных в целях, которые тесно связаны с подписанием и выполнением Контракта.

8.3 В частности, Покупатель признает, что его персональные данные и/или его персонала и/или сотрудников, привлеченных к оговоренной в Контракте деятельности, будут обрабатываться Продавцом в качестве Автономного оператора обработки в целях и в порядке, которые приводятся в «Памятке для клиентов», которая в соответствии со ст. 13 и 14 ОРЗД опубликована на сайте www.emilgroup.it в разделе Конфиденциальность, содержание которой Покупатель уже сейчас обязуется довести до сведения своего персонала и/или сотрудников.

9. Прекращение действия Контракта

9.1 В соответствии со ст. 1456 Г.К. Продавец имеет право немедленно расторгнуть любой контракт с Покупателем, сообщив ему об этом заказным письмом, в котором он заявляет о желании воспользоваться данным положением о расторжении, в следующих случаях:

- если Покупатель не выполняет обязанности, изложенные в ст. 3.9, 4 и 7 данных Общих условий продажи;
- если Покупатель является ответственным за серьезное невыполнение контрактных обязательств.

9.2 Продавец имеет право немедленно расторгнуть любой контракт, отправив Покупателю сообщение заказным письмом, в котором он заявляет о желании воспользоваться данным положением о расторжении:

- в случаях, изложенных в ст. 1.3, 3.7, 6.1.
- если по отношению к Покупателю применяются исполнительные процедуры, конкурсное управление или ликвидация;
- если имущественное, экономическое и финансовое состояние Покупателя позволяют с уверенностью предположить кризисное положение Покупателя;
- если пакет акций и/или доля, обеспечивающие контроль над уставным капиталом общества Покупателя - если юридической формой является общество - были прямо или косвенно уступлены, отчуждены или обременены предоставлением в залог.

10. Положение о сохранении права собственности

Продавец сохраняет право собственности на Продукцию вплоть до полной оплаты установленной стоимости. Следовательно, Покупатель обязуется i) правильно использовать ее, в соответствии с назначением; ii) не передавать третьим лицам право собственности и использования, если на это нет специального предварительного разрешения Продавца. При отсутствии полной или частичной оплаты поставок Покупателем до установленной даты, по простому запросу, Продавец может вернуть в свою собственность поставленную продукцию. Несмотря на вышесказанное, Покупатель несет ответственность за любой ущерб и утрату, возникшие после поставки, даже если они вызваны случайностью, форс-мажором или же событиями, не вменяемыми в вину Покупателю.

11. Применимое законодательство и компетентный суд

11.1 Данные Общие условия продажи и любой Контракт, заключенный Покупателем с Продавцом, регулируется итальянским законодательством.

11.2 Любые споры, возникающие между Сторонами по поводу интерпретации, действительности или выполнения данных Общих условий продажи и любого Контракта, находятся в исключительной компетенции Суда Модены.

11.3 Стороны договариваются, что лишь только Продавец, по собственному усмотрению, имеет право отказа от исключительной компетенции суда, оговоренной в ст. 11.2 выше, чтобы производить судебные действия против Покупателя по адресу его domicilio и в находящемся там суде.

11.4 Для интерпретации положений о поставке и других коммерческих положений, которые могут быть использованы сторонами, следует обращаться к правилам Incoterms 2020 Парижской международной торговой палаты и к Сборнику практик 2005 г. Торговой палаты Модены применительно к керамическим материалам.

12. Бренды и отличительные знаки Продавца

12.1 Покупатель обязан использовать бренды, названия или другие отличительные знаки Продавца, но лишь только в целях идентификации и рекламы Продукции, так как подразумевается, что данное использование осуществляется в интересах Продавца. Тем не менее, любое использование брендов, названий или отличительных знаков Продавца на фирменных бланках Покупателя, в рекламных материалах или в других материалах, предназначенных для третьих лиц, должно быть предварительно согласовано с Продавцом в письменной форме.

12.2 Продавец обязуется не использовать бренды, названия и отличительные знаки Продавца в своей организации, названии компании или интернет-доме-нах. В любом случае, Покупатель обязуется не регистрировать бренды и/или отличительные знаки Продавца, включая интернет-домены.

12.3 Право Покупателя использовать бренды, названия или другие отличительные знаки владельца, как предусматривается в ст. 12.1 выше, будет аннулировано сразу поле истечения или расторжения по какой бы то ни было причине данных Общих условий продажи или же любого Контракта, заключенного между Покупателем и Продавцом.

12.4 Покупатель сообщит Продавцу о любом нарушении, которое станет ему известным, использования брендов, названий или других отличительных знаков Продавца.

13. Заключительные положения

13.1 Полная или частичная недействительность отдельных положений данных Общих условий продажи не влияет на действительность остальных.

13.2 Данные Общие условия продажи могут быть изменены, дополнены и модифицированы лишь только Продавцом, в письменном виде.

EMIL CERAMICA

COORDINAMENTO

Ufficio Marketing Emilceramica Group

COPYRIGHT © EMILCERAMICA SRL
APRILE 2021

 17 DoP - F
Emilceramica S.r.l. a socio unico Via Ghiarola Nuova, 29 41042 Fiorano Modenese (MO) - Italia Tel. +39 0536 835 111
EN 14411
Dry-pressed ceramic tiles, with water absorption $E_w \leq 0,5\%$, for internal and external walls and floorings

I colori e le caratteristiche estetiche dei materiali illustrati nel presente catalogo sono da ritenersi puramente indicativi. Le misure dei prodotti qui indicate si intendono nominali e come i pesi ed i colori subiscono le variazioni tipiche del processo ceramico. Emilceramica si riserva la facoltà di modificare in qualunque momento senza preavviso le caratteristiche tecniche, estetiche e i materiali presentati. Tali caratteristiche non sono comunque vincolanti nei termini legali.

Colours and optical features of the materials illustrated in this catalogue are to be regarded as mere indications. Product sizes indicated are nominal and like weights and colours undergo the typical variations of the ceramic process. Emilceramica reserves the right to change the technical and optical features of the materials illustrated at any time and without notice. These features are not legally binding.

Les coloris et les caractéristiques esthétiques des références illustrées dans le catalogue sont donnés à titre purement indicatif. Les caractéristiques indiquées concernant les dimensions des articles, sont à considérer nominale et les coloris elles peuvent subir des variations dues au procédé céramique. La Société Emilceramica se réserve le droit de modifier à tout moment et sans aucun préavis les caractéristiques techniques et esthétiques des produits présentés dans son catalogue. Ces modifications ne pourront pas entraîner de procédures légales.

Die Farben und die ästhetischen Eigenschaften der in diesem Katalog abgebildeten Produkte sind als reine Richtwerte zu betrachten. Die hier angegebenen Abmessungen verstehen sich als Sollwerte und sind (wie Gewicht und Farbe) den typischen Änderungen des Keramikprozesses ausgesetzt. Emilceramica behält sich das Recht vor die technischen und ästhetischen Eigenschaften der vorgestellten Produkte jederzeit ohne Voranzeige zu ändern. Obengenannte Eigenschaften sind jedoch rechtmäßig nicht verbindlich.

Los colores y las características de los materiales ilustrados en el presente catálogo son para retenerse solo indicativamente. Las medidas de los productos aquí indicados se entienden nominalmente y como el peso y los colores sometidos a las variaciones típicas del procedimiento cerámico. Emilceramica se reserva la facultad de modificar en cualquier momento sin preaviso las características técnicas, estéticas y los materiales presentados. Tales características no son vinculantes en términos legales.

Цвета и внешние характеристики материала, представленного в каталоге, должны расцениваться как приблизительные. Указанные размеры продукции являются номинальными, и, также как и вес и цвета, подвергаются типичным для керамического процесса изменениям. Emilceramica оставляет за собой право изменять в любой момент без какого-либо предупреждения представленные технические и внешние характеристики материалы. Данные характеристики не влекут за собой ответственности для продавца с юридической точки зрения.



Emilceramica is a brand of Emilceramica S.r.l. a socio unico	Sede Commerciale/ Amministrativa
emilgroup.it/emilceramica emilgroup.it	Via Ghiarola Nuova, 29 - 41042 Fiorano Modenese (Mo) Italy T +39 0536 835111 - info@emilceramicagroup.it